

User Manual



AWG2041 **Arbitrary Waveform Generator**

070-9456-02

CE

Copyright © Sony/Tektronix Corporation, 1995. All rights reserved.

Copyright © Tektronix, Inc., 1995. All rights reserved.

Tektronix products are covered by U.S. and foreign patents, issued and pending. Information in this publication supercedes that in all previously published material. Specifications and price change privileges reserved.

Printed in Japan.

Sony/Tektronix Corporation, P.O.Box 5209, Tokyo Int'l, Tokyo 100-31 Japan

Tektronix, Inc., P.O. Box 1000, Wilsonville, OR 97070-1000

TEKTRONIX and TEK are registered trademarks of Tektronix, Inc.

WARRANTY

Tektronix warrants that this product will be free from defects in materials and workmanship for a period of one (1) year from the date of shipment. If any such product proves defective during this warranty period, Tektronix, at its option, either will repair the defective product without charge for parts and labor, or will provide a replacement in exchange for the defective product.

In order to obtain service under this warranty, Customer must notify Tektronix of the defect before the expiration of the warranty period and make suitable arrangements for the performance of service. Customer shall be responsible for packaging and shipping the defective product to the service center designated by Tektronix, with shipping charges prepaid. Tektronix shall pay for the return of the product to Customer if the shipment is to a location within the country in which the Tektronix service center is located. Customer shall be responsible for paying all shipping charges, duties, taxes, and any other charges for products returned to any other locations.

This warranty shall not apply to any defect, failure or damage caused by improper use or improper or inadequate maintenance and care. Tektronix shall not be obligated to furnish service under this warranty a) to repair damage resulting from attempts by personnel other than Tektronix representatives to install, repair or service the product; b) to repair damage resulting from improper use or connection to incompatible equipment; or c) to service a product that has been modified or integrated with other products when the effect of such modification or integration increases the time or difficulty of servicing the product.

THIS WARRANTY IS GIVEN BY TEKTRONIX WITH RESPECT TO THIS PRODUCT IN LIEU OF ANY OTHER WARRANTIES, EXPRESSED OR IMPLIED. TEKTRONIX AND ITS VENDORS DISCLAIM ANY IMPLIED WARRANTIES OF MERCHANTABILITY OR FITNESS FOR A PARTICULAR PURPOSE. TEKTRONIX' RESPONSIBILITY TO REPAIR OR REPLACE DEFECTIVE PRODUCTS IS THE SOLE AND EXCLUSIVE REMEDY PROVIDED TO THE CUSTOMER FOR BREACH OF THIS WARRANTY. TEKTRONIX AND ITS VENDORS WILL NOT BE LIABLE FOR ANY INDIRECT, SPECIAL, INCIDENTAL, OR CONSEQUENTIAL DAMAGES IRRESPECTIVE OF WHETHER TEKTRONIX OR THE VENDOR HAS ADVANCE NOTICE OF THE POSSIBILITY OF SUCH DAMAGES.



EC Declaration of Conformity

We

Tektronix Holland N.V.
Marktweg 73A
8444 AB Heerenveen
The Netherlands

declare under sole responsibility that the

AWG2041 Arbitrary Waveform Generator instruments

meets the intent of Directive 89/336/EEC for Electromagnetic Compatibility.
Compliance was demonstrated to the following specifications as listed in the Official
Journal of the European Communities:

EN 55011 Class A Radiated and Conducted Emissions

EN 50081-1 Emissions:

EN 60555-2 AC Power Line Harmonic Emissions

EN 50082-1 Immunity:

IEC 801-2 Electrostatic Discharge Immunity

IEC 801-3 RF Electromagnetic Field Immunity

IEC 801-4 Electrical Fast Transient/Burst Immunity

Contents

Contents	i
List of Figures	xiii
List of Tables	xxiii
General Safety Summary	xxv
Welcome	xxix
Related Manuals	xxix
Conventions	xxx
Trademarks	xxx

Getting Started

Overview	1-1
Product Description	1-1
Initial Inspection	1-2
Start Up	1-3
Installation	1-3
Power On	1-5
Start-up Diagnostics / Calibrations	1-8
Power Off	1-8

Operating Basics

Introduction	2-1
Overview	2-3
Front Panel	2-3
Side Panel	2-9
Rear Panel	2-10
CRT Display	2-13
Basic Menu Operation	2-15
Menu Operations	2-15
Menu Names	2-16
Numeric Input	2-16
Using the Front Panel Numeric Keys	2-17
Using the General Purpose Knob	2-20
Operating Examples	2-23
Necessary Equipment	2-23

Example 1: Setting the Date & Time and Adjusting the Brightness	2-24
Setting the Date and Time	2-24
Date/Time Display	2-25
Setting the Display Brightness	2-26
Example 2: Output of a Waveform Using the Sample Waveform Library Disk	2-27
Loading Sample Waveforms	2-27
Setting the Output Parameters	2-30
Waveform Output	2-32
Example 3: Creating Files and Arbitrary Waveform Outputs .	2-34
Creating a Waveform File	2-34
Creating Arbitrary Waveforms Using the Point Draw Function ...	2-41
Creating Waveforms Arithmetically	2-45
Creating an Equation File	2-47
Creating a Sequence File	2-51
Creating An Autostep File	2-54
Setting the Output Parameters	2-57
Setting Operation Mode and Waveform Output	2-59
Example 4: Loading and Saving Files	2-65
Saving Files	2-65
Loading Files	2-67
Auto Load	2-69
Example 5: Loading Waveforms From Other Instruments ...	2-71
Example 6: Using the Waveform Function Generator	2-75
Waveform Settings	2-75
Waveform Output	2-77

Functional Operation Summary

Introduction	3-1
Block Diagram	3-3
Clock Generator	3-5
Trigger Control	3-5
Operations in Trigger Mode	3-5
Cont Mode	3-5
Triggered and Burst Modes	3-6
Gated Mode	3-6
Parallel Operation	3-6
Simple Parallel Operation (1)	3-6
Simple Parallel Operation (2)	3-7
Parallel Output Synchronous with the Clock Signal	3-8
Timing of Trigger Input, Auxiliary Input and Waveform Output ...	3-9
Memory Control	3-10
Memory Address Control	3-10
Hardware Sequencer On	3-10
Hardware Sequencer Off	3-11

Waveform Memory	3-11
Loading Sequence Files	3-12
Loading Sequence Files in the Waveform Advance Mode ..	3-14
D/A Converter	3-14
Digital Data Output (Option 03)	3-14
Data Length	3-14
Analog Circuit	3-15
Filter	3-15
Variable Gain, Attenuators	3-16
Offset	3-16

Reference

Introduction	4-1
Menu Items Available With Each Editing Function	4-1
EDIT Menu	4A-1
General Description	4A-1
Initial Menu	4A-3
Initial Menu Structure	4A-3
Menu Functions	4A-4
CRT Display	4A-5
Creating or Editing a File	4A-7
Creating a New File	4A-7
Editing an Existing File	4A-7
Using File Editing Functions	4A-8
Renaming a File	4A-8
Comment Input	4A-9
Copying a File	4A-9
Deleting a File	4A-9
Locking and Unlocking Files	4A-11
Expanding a Sequence File into a Waveform File	4A-12
Waveform Editor	4A-15
Entering the Waveform Editor	4A-15
Opening and Selecting Editing Areas	4A-16
Saving Files and Exiting the Editor	4A-21
Choices When Exiting the Editor	4A-21
Naming a File	4A-22
Graphic Display	4A-27
Graphic Display Menu Structure	4A-27
Menu Functions	4A-29
Graphic Display Screen	4A-30
Settings for the Waveform to be Edited	4A-32
Selecting the Waveform Data Display Format	4A-32
Setting Waveform Point Count	4A-33
Setting Horizontal Axis Units	4A-34
Setting Clock Frequency	4A-35
Linking the Vertical Bar Cursors	4A-36

Displaying a Grid in the Editing Area	4A-38
Creating a Standard Function Waveform	4A-39
Selecting Function Waveform Type and Calculation Method	4A-39
Setting the Parameters for Function Waveforms	4A-40
Procedure 1: Creating a Sine Wave	4A-40
Procedure 2: Adding a Waveform to Existing Data	4A-41
Procedure 3: Multiplying Waveforms	4A-43
Editing Waveforms in Graphic Display	4A-44
Setting Editing Areas	4A-44
Cutting Waveforms	4A-45
Copying/Pasting Waveforms	4A-46
Draw Function	4A-48
Shift Function	4A-51
Scaling Function	4A-53
Invert Function	4A-57
Clip Function	4A-59
Setting a Marker	4A-60
Setting a Marker Pattern	4A-61
Inserting Other Waveforms	4A-63
Single Waveform Calculations	4A-66
Calculations With Other Waveform Data	4A-71
Specified Region Shift	4A-74
The Shift Values For Selecting Expand or Compress	4A-76
Interpolation	4A-77
Data Value	4A-79
Cursor Point	4A-79
Smooth +/- Points	4A-79
Increasing the Size of the Area	4A-81
Multiple Copy	4A-82
Convolution Calculations	4A-89
Comparing Waveforms	4A-92
Zooming Waveforms	4A-97
Horizontal Zooming	4A-97
Vertical zooming	4A-99
Timing Display	4A-100
Timing Display Menu Structure	4A-101
Menu Functions	4A-103
Timing Display Screen	4A-104
Settings for the Waveform to be Edited	4A-105
Creating Standard Waveform Data	4A-105
Pattern Types	4A-105
Example of Waveform Data Creation	4A-107
Editing Waveform in Timing Display	4A-108
Cut, Copy, and Paste Processing Function	4A-108
Setting Waveform Data	4A-108
Setting Data to High/Low	4A-109
Setting Pattern Data	4A-110

Entering Pattern Data and Pattern Length	4A-110
Changing the Data Bits	4A-111
Point/Step	4A-112
Pattern Code	4A-112
Clearing Pattern Data	4A-112
Shifting Waveform Data	4A-120
Inverting Waveform Data	4A-121
Copying Lines	4A-122
Exchanging Lines	4A-124
Applying Logical Operations to Lines	4A-125
Types of Logical Operations	4A-125
Expanding Waveform Data	4A-126
Inserting Other Waveform Data	4A-127
Pseudo-Random Pulse Generator Using Shift Register .	4A-127
Register Configuration	4A-127
Setting the Register Length	4A-128
Entering the Register Value and Setting Taps	4A-128
Clearing All Taps	4A-128
Setting the Maximum Length Code Series for Taps .	4A-129
Setting Register Values	4A-129
Sample Settings for Register Values and Taps	4A-129
Point/Step	4A-129
User defined Code Config...	4A-130
Creating the M Series Pseudo-Random Signal	4A-130
Zooming Waveforms	4A-132
Table Display	4A-133
Table Display Menu Structure	4A-134
Menu Functions	4A-135
Table Display Screen	4A-136
Settings for the Waveform to be Edited	4A-138
Setting a Cardinal Number	4A-138
Editing Waveform Data	4A-139
Editing Waveform in Table Display	4A-140
Cut, Copy, and Paste Processing Function	4A-140
Inserting Other Waveform Data	4A-140
Equation Editor	4A-141
Entering the Equation Editor	4A-142
Saving Files and Exiting the Editor	4A-142
Equation Editor Menu Structure	4A-143
Menu Functions	4A-144
Equation Editor Menu Display	4A-145
Creating and Editing Equation Files	4A-147
Creating an Equation	4A-147
Specifying the Time Domain	4A-147
Using the Front Panel Buttons in Editing	4A-148
Decimal Point	4A-149
Component Menu	4A-149

Editing Functions	4A-160
Cutting a line	4A-160
Copying and Pasting a Line	4A-160
Insert Other Equation File	4A-161
Setting Waveform Point Count	4A-162
Compiling Equations into Waveform Data	4A-163
Sequence Editor	4A-165
Entering the Sequence Editor	4A-166
Saving Files and Exiting the Editor	4A-166
Sequence Editor Menu Structure	4A-167
Menu Functions	4A-167
Sequence Editor Menu Display	4A-168
Creating and Editing Sequence Files	4A-170
Creating a Sequence File	4A-170
Button Functions	4A-171
Editing Functions	4A-172
Cutting a Line	4A-172
Copying and Pasting a Line	4A-172
Catalog File Waveform Display	4A-173
Inserting a Sequence File	4A-174
Sequence File Display	4A-175
Autostep Editor	4A-176
Entering the Autostep Editor	4A-177
Saving Files and Exiting the Editor	4A-177
Autostep Editor Menu Structure	4A-178
Menu Functions	4A-179
Autostep Editor Menu Display	4A-180
Creating and Editing Autostep Programs	4A-181
Setting Files	4A-182
Changing Parameters	4A-184
Clock Settings	4A-185
Filter Settings	4A-186
Amplitude Settings	4A-187
Offset Settings	4A-188
Marker Settings	4A-189
Editing Functions	4A-190
Cutting a Step	4A-190
Copying and Pasting a Step	4A-190
Adding a Step	4A-191
Inserting the SETUP Menu Waveforms and Output Parameters	4A-191
Jumping to a Step	4A-191
Split/Join Waveform Editor (Option 09)	4A-192
Entering the Split/Join Waveform Editor	4A-192
Exiting the Editor	4A-192
Split/Join Waveform Editor Menu Structure	4A-193
Menu Functions	4A-194
Split/Join Waveform Editor Display	4A-195

Splitting Waveform File	4A-197
Copying and Cutting Part of a Waveform File	4A-199
Inserting Waveform File	4A-200
Convolution Waveform Editor (Option 09)	4A-202
Entering the Convolution Waveform Editor	4A-202
Saving Files and Exiting the Editor	4A-203
Convolution Waveform Editor Menu Structure	4A-203
Menu Functions	4A-203
Convolution Waveform Editor Menu Display	4A-204
Selecting a Waveform File	4A-205
Executing Convolution/Correlation	4A-206
FFT Editor (Option 09)	4A-208
Entering the FFT Editor	4A-208
Saving Files and Exiting the Editor	4A-210
FFT Editor Menu Structure	4A-210
Menu Functions	4A-211
FFT Editor Menu Display	4A-212
Editing in the Frequency Domain	4A-214
Editing Magnitude	4A-214
Editing Phase	4A-215
Searching for Peaks	4A-215
Drawing Magnitude and Phase	4A-215
Zooming a Signal	4A-218
Selecting a Filter	4A-219
Selecting a Limiter	4A-221
Cutting Extraneous Frequency Components	4A-221
Deleting Even or Odd Components	4A-221
Sifting Magnitudes	4A-222
SETUP Menu	4B-1
General Description	4B-1
SETUP Menu Structure	4B-2
MENU Functions	4B-3
SETUP Menu Display	4B-3
Selecting the Display Format for the SETUP Menu	4B-5
Selecting a Waveform or Sequence File	4B-6
Loading Waveform Files That Are Not a Multiple of 32	4B-7
Loading Sequence Files in Waveform Advance Mode (Hardware Sequencer Off)	4B-8
Loading Sequence Files in Waveform Advance Mode (Hardware Sequencer On)	4B-10
Setting Clock Source and Frequency	4B-10
Setting Filter	4B-12
Setting Amplitude and Offset	4B-12
Setting Amplitude	4B-13
Setting Offset	4B-13
Setting Marker Level	4B-14
MODE Menu	4C-1

General Description	4C-1
MODE Menu Structure	4C-2
Menu Functions	4C-3
MODE Menu Display	4C-4
Setting the Operating Mode	4C-6
Cont Mode	4C-6
Triggered Mode	4C-6
Gated Mode	4C-8
Burst Mode	4C-9
Waveform Advance Mode	4C-10
Hardware Sequencer Off	4C-11
Hardware Sequencer On	4C-13
Autostep Mode	4C-15
Starting an Autostep Program	4C-15
Setting Trigger Parameters for an External Trigger (gate) ...	4C-19
Slave Mode	4C-20
LOAD/SAVE Menu	4D-1
General Description	4D-1
Memory Capacity	4D-2
LOAD/SAVE Menu Structure	4D-3
Menu Functions	4D-3
LOAD Menu Display	4D-4
Selecting the Device	4D-6
Loading Files from Mass Memory into Internal Memory	4D-8
Loading Autostep Files	4D-9
Saving Files from Internal Memory to Mass Memory	4D-10
Saving Data in Text Format	4D-11
Transferring Waveform Data Directly	4D-12
Loading Waveform Data	4D-12
Selecting Instruments Made by Other Manufacturers	4D-14
Auto Loading	4D-15
Supported Floppy Disk Files	4D-16
UTILITY Menu	4E-1
General Description	4E-1
UTILITY Menu Structure	4E-2
Menu Functions	4E-3
Disk and Nonvolatile Memory	4E-4
Using the Disk Menu	4E-4
Floppy Disk Format	4E-4
Handling Floppy Disks	4E-7
Protecting Disks From Accidental Erasure	4E-7
Creating and Changing Directories	4E-8
Operating Files Saved to Disk	4E-12
Locking and Unlocking a File	4E-12
Internal Non-volatile Memory	4E-12
Remote Interface	4E-13

GPIB	4E-13
GPIB Connection	4E-13
Setting GPIB Configuration	4E-13
RS-232-C	4E-15
RS-232-C Connection	4E-15
Setting the RS-232-C Parameters	4E-15
Date and Time	4E-17
Setting the Date and Time	4E-17
Other Settings and Displays	4E-18
Setting the Display	4E-18
Setting the Display Brightness	4E-19
Setting the Order of Files	4E-19
Date/Time Display	4E-22
Configuration	4E-23
Factory Settings	4E-23
Deleting Data From Memory	4E-23
Remote Port Settings	4E-24
Setting the Hardware Sequencer	4E-25
Settings for Hard Copy Output	4E-26
Selecting the Format	4E-26
Selecting the Port	4E-27
Status Display	4E-29
System and GPIB/RS-232-C Status	4E-29
I/O Event Reporting	4E-30
Diagnostics and Calibration	4E-31
Diagnostics	4E-31
Calibration	4E-32
Pattern Display (For Instrument Adjustment)	4E-33
Function Waveform Generator Mode	4F-1
General Description	4F-1
Function Generator Menu Structure	4F-2
Function Generator Menu Display	4F-3
Setting the Output Waveform	4F-4
Setting the Output Parameters for the Waveform	4F-5
Setting the Frequency	4F-5
Setting the Amplitude	4F-5
Setting the Offset	4F-5
Setting the Polarity	4F-6
Setting the Duty	4F-6
Marker Output	4F-7

Appendices

Appendix A: Options and Accessories	A-1
Options	A-1
Option 01 (4M-word Waveform Memory)	A-1
Option 03 (Digital Data Output)	A-1

Option 09 (FPP Board + FFT Editor, Convolution, Split/Join) . . .	A-2
Option 1R (Rack Mount)	A-2
Option 1S (With WaveWriter S3FT400)	A-2
Option 95 (Certificate with Calibration Data)	A-2
Option B1 (With Service Manual)	A-2
Power Cord Options	A-3
Accessories	A-3
Standard Accessories	A-3
Optional Accessories	A-4
Appendix B: Performance Characteristics	B-1
Introduction	B-1
Nominal Traits	B-2
Warranted Characteristics	B-7
Performance Conditions	B-7
Typical Characteristics	B-13
Appendix C: Sample Waveform Library	C-1
Introduction	C-1
Description of Representative Waveform Files	C-2
Appendix D: Miscellaneous	D-1
General Description	D-1
Horizontal Axis Scaling	D-1
Sampling Theorem	D-3
Differentiation	D-3
Integration	D-4
Random (rnd) Function	D-5
Pattern Codes	D-6
Logical Operation	D-10
FFT (Fast Fourier Transforms)	D-13
Basic FFT Rules	D-13
Record Length and Frequency Resolution	D-13
Relationship Between Phase and Delay	D-14
FFT Window Functions	D-15
Square Wave Window	D-16
Hanning Window	D-16
Hamming Window	D-17
Blackman-Harris Window	D-17
Blackman Window	D-18
Triangle Wave Window	D-18
Repackaging for Shipment	D-19
Factory Settings	D-20
Appendix E: Performance Verification Procedure	E-1
Preparation	E-1
Conventions	E-1
Self Tests	E-3

Diagnostics	E-3
Calibration	E-5
Performance Tests	E-7
Prerequisites	E-7
Related Information	E-8
Equipment Required	E-8
Loading Files	E-10
Performance Check/Adjustment Files	E-11
Operating Mode Checks	E-13
Check Cont Mode	E-13
Check Triggered Mode	E-14
Check Gated Mode	E-16
Check Burst Mode	E-19
Check Waveform Advance Mode (Hardware Sequencer: On)	E-20
Check Waveform Advance Mode (Hardware Sequencer: Off)	E-22
Check Autostep Mode	E-23
Check Slave Mode	E-26
Clock Frequency Check	E-29
Check Clock Frequency Accuracy	E-29
Amplitude and Offset Accuracy Checks	E-30
Check Amplitude Accuracy	E-30
Check Offset Accuracy	E-32
Pulse Response Checks	E-34
Sine Wave Checks	E-36
AUX Output Checks	E-37
External Trigger Input Checks	E-43
External CLOCK IN Check	E-47
Digital Data Out Checks (Option 03)	E-49
Floating Point Processor Check (Option 09)	E-51

List of Figures

Figure 1-1: Rear Panel Controls Used In Start Up	1-5
Figure 1-2: Optional Power Cords	1-6
Figure 1-3: ON/STBY Switch	1-7
Figure 2-1: Front Panel Overall View	2-3
Figure 2-2: Front Panel Button Detail	2-5
Figure 2-3: Side Panel	2-9
Figure 2-4: Rear Panel Overall View	2-10
Figure 2-5: Rear Panel Detail	2-11
Figure 2-6: CRT Display	2-13
Figure 2-7: Menu Buttons and Bezel Buttons	2-15
Figure 2-8: Numeric Input Using Numeric Keys	2-17
Figure 2-9: Numeric Keys, Unit Keys, Delete Key, and ENTER Key ..	2-18
Figure 2-10: General Purpose Knob, and Arrow Buttons	2-20
Figure 2-11: Knob Icon and Underscore	2-20
Figure 2-12: Menu Display (showing Date/Time item selected)	2-24
Figure 2-13: Date/Time Display	2-25
Figure 2-14: Setting the Display Brightness	2-26
Figure 2-15: Inserting the Floppy Disk	2-27
Figure 2-16: Sample Waveform Library Disk Files	2-28
Figure 2-17: CRT Screen Display When Load All is Selected	2-29
Figure 2-18: SETUP Menu	2-30
Figure 2-19: Waveform File List	2-31
Figure 2-20: GAUSS_P.WFM File Output Parameters	2-31
Figure 2-21: MODE Menu	2-32
Figure 2-22: Connections in Example 2	2-33
Figure 2-23: Channel On/Off Buttons and Indicators	2-33
Figure 2-24: Initial Menu	2-34
Figure 2-25: Waveform Editor Graphic Menu	2-35
Figure 2-26: Setting the Point Value for the Right Side Vertical Bar Cursor	2-36
Figure 2-27: Creating a Sine Waveform	2-37
Figure 2-28: Creating a Ramp Waveform	2-38
Figure 2-29: Naming a File	2-39
Figure 2-30: Initial Menu File List	2-40
Figure 2-31: Entering a Name for the Copied File	2-41
Figure 2-32: Setting the Edit Range	2-42
Figure 2-33: Drawing a Waveform Using the Point Draw Function ..	2-43
Figure 2-34: Connecting the Points	2-44
Figure 2-35: Creating a Sine Wave	2-45
Figure 2-36: Sine Wave With Noise Added	2-46

Figure 2-37: Equation Editor Menu Display	2-47
Figure 2-38: Equation List Input	2-48
Figure 2-39: Display of Compiled Waveform Data	2-49
Figure 2-40: Initial Menu File List	2-50
Figure 2-41: Sequence Editor Menu Display	2-51
Figure 2-42: Sequence Example	2-52
Figure 2-43: Sequence Waveform Display With Show Overview Selected	2-53
Figure 2-44: Autostep Editor Menu Display	2-54
Figure 2-45: File List	2-55
Figure 2-46: Setting Files	2-55
Figure 2-47: Setting the Files for Step 2	2-56
Figure 2-48: SETUP Menu	2-57
Figure 2-49: Setting Output Parameters	2-58
Figure 2-50: Connections for Example 3	2-59
Figure 2-51: MODE Menu	2-60
Figure 2-52: Setting the Marker Default	2-61
Figure 2-53: Menu Display When Triggered is Selected	2-62
Figure 2-54: MANUAL Button and TRIGGER INPUT Connector	2-62
Figure 2-55: Menu Display When Autostep is Selected	2-63
Figure 2-56: Autostep File List	2-64
Figure 2-57: SAVE Menu	2-66
Figure 2-58: Files Saved in NVRam	2-67
Figure 2-59: Internal Memory File List	2-68
Figure 2-60: Files Loaded into Internal Memory	2-69
Figure 2-61: Connections for Example 5	2-71
Figure 2-62: DSO Screen	2-72
Figure 2-63: Confirmation Message (asking if it is O.K. to change the remote port and GPIB configuration settings)	2-72
Figure 2-64: GPIB Source List	2-73
Figure 2-65: Screen When Pulse Set	2-75
Figure 2-66: Output Parameter Setting Display	2-77
Figure 2-67: Connections for Example 6	2-77
Figure 3-1: Block Diagram (1)	3-3
Figure 3-2: Block Diagram (2)	3-4
Figure 3-3: Clock Generator	3-5
Figure 3-4: Sample Connection 1	3-6
Figure 3-5: Sample Connection 2	3-7
Figure 3-6: Connections for Synchronized Parallel Operation with Three AWG2041	3-8
Figure 3-7: Waveform Timing	3-9
Figure 3-8: Relationship Between Memory Address Control and Waveform Memory	3-10
Figure 3-9: Waveform Memory	3-12
Figure 3-10: Expanding a Sequence File (Hardware Sequencer Off)	3-13
Figure 3-11: Relationship Between Triangular Wave Resolution and Number of Data Points	3-15
Figure 3-12: Attenuators	3-16
Figure 3-13: Offset Circuit	3-16

Figure 4A-1: Initial EDIT Menu Structure	4A-3
Figure 4A-2: Display of the Initial Menu	4A-5
Figure 4A-3: Menu Displayed When Rename is Selected	4A-8
Figure 4A-4: Menu Displayed When Delete is Selected	4A-10
Figure 4A-5: Menu Displayed When Lock is Selected	4A-11
Figure 4A-6: Menu Displayed When Expand SEQ into WFM is Selected	4A-12
Figure 4A-7: Graphic Display Screen	4A-16
Figure 4A-8: Waveform Editor With Three Editing Areas	4A-17
Figure 4A-9: Menu Display When "Another Waveform" is Selected .	4A-18
Figure 4A-10: Waveform2 Added	4A-19
Figure 4A-11: Menu Display When Show Catalog Entry is Selected .	4A-19
Figure 4A-12: Waveform3 Added	4A-20
Figure 4A-13: Menu for Inputting a File Name	4A-22
Figure 4A-14: Fraction Processing Menu	4A-24
Figure 4A-15: Fraction Processing	4A-25
Figure 4A-16: Fraction Processing	4A-25
Figure 4A-17: Waveform Editor Graphic Display Menu Structure ...	4A-28
Figure 4A-18: Graphic Display Screen	4A-30
Figure 4A-19: Setting the Unit for the Horizontal Axis	4A-34
Figure 4A-20: Menu Display When Clock is Selected	4A-35
Figure 4A-21: Sub-Menu Display When Cursor Link to... is Selected	4A-36
Figure 4A-22: Grid Set to On	4A-38
Figure 4A-23: Creating a Sine Wave	4A-41
Figure 4A-24: Adding Noise to the Sine Wave	4A-42
Figure 4A-25: Multiplying Sine Waves	4A-43
Figure 4A-26: Defining the Editing Area	4A-45
Figure 4A-27: Cutting Waveforms	4A-46
Figure 4A-28: Pasting Waveforms	4A-47
Figure 4A-29: Menu Display When Draw... Item is Selected	4A-48
Figure 4A-30: Smoothing	4A-50
Figure 4A-31: Horizontally Shifted Display	4A-52
Figure 4A-32: Vertically Shifted Display	4A-53
Figure 4A-33: Display Expanded Horizontally	4A-54
Figure 4A-34: Display Expanded to x1.5 Vertically	4A-56
Figure 4A-35: Horizontally Inverted Display	4A-57
Figure 4A-36: Vertically Inverted Display	4A-58
Figure 4A-37: Display of Waveform Clipped Above Clip Level	4A-59
Figure 4A-38: Marker Signal Set High	4A-61
Figure 4A-39: Entering Pattern Data	4A-62
Figure 4A-40: Defining the Location for Insertion	4A-63
Figure 4A-41: List of Files for Insertion	4A-64
Figure 4A-42: File Waveform Display	4A-64
Figure 4A-43: Inserting Waveforms	4A-65
Figure 4A-44: Waveform Example before Calculation	4A-66
Figure 4A-45: Absolute Calculation	4A-67
Figure 4A-46: Square Calculation	4A-68
Figure 4A-47: Cube Calculation	4A-68

Figure 4A-48: Square Root Calculation	4A-69
Figure 4A-49: Normalize Calculation	4A-69
Figure 4A-50: Integral Calculation	4A-70
Figure 4A-51: Differential Calculation	4A-70
Figure 4A-52: Example of Waveform Before Arithmetic Operations .	4A-71
Figure 4A-53: List of Files for Waveform Calculation	4A-72
Figure 4A-54: Selected File Waveform Display	4A-72
Figure 4A-55: Waveform Addition Display	4A-73
Figure 4A-56: Data Shifted Using the "Right" Item	4A-75
Figure 4A-57: Data Compressed Using the "Compress" Item	4A-75
Figure 4A-58: Linear Interpolation	4A-77
Figure 4A-59: Quadratic Interpolation	4A-78
Figure 4A-60: Shift with "Cursor Point" Set to "Exclude"	4A-79
Figure 4A-61: Smoothing	4A-80
Figure 4A-62: Data Shifting	4A-80
Figure 4A-63: Increasing the Size of the Area	4A-81
Figure 4A-64: Two Waveform Editing Areas Designated	4A-83
Figure 4A-65: Setting the Copy Source	4A-84
Figure 4A-66: Setting the Copy Destination	4A-85
Figure 4A-67: Waveform Copying (number of points in waveform = Interval value)	4A-86
Figure 4A-68: Waveform Copying (number of points in waveform < Interval value)	4A-87
Figure 4A-69: Waveform Copying (number of points in waveform > Interval value)	4A-88
Figure 4A-70: Setting the Area for Convolution	4A-90
Figure 4A-71: Convolution	4A-91
Figure 4A-72: Menu Display When Compare... is Selected	4A-94
Figure 4A-73: Comparison Without Hysteresis	4A-95
Figure 4A-74: Comparison With Hysteresis	4A-96
Figure 4A-75: Zoom Menu	4A-97
Figure 4A-76: Horizontal Zoom	4A-98
Figure 4A-77: Vertical Zoom	4A-99
Figure 4A-78: Timing Display	4A-100
Figure 4A-79: Waveform Editor Timing Display Menu Structure	4A-102
Figure 4A-80: Timing Display	4A-104
Figure 4A-81: Count Up Pattern Display	4A-106
Figure 4A-82: Gray Code Pattern Display	4A-107
Figure 4A-83: Setting Waveform Data to High/Low	4A-109
Figure 4A-84: Pattern Data Setting Menu	4A-110
Figure 4A-85: Setting Pattern Data	4A-114
Figure 4A-86: User defined Code Conversion Menu	4A-115
Figure 4A-87: Shifting Waveform Data	4A-121
Figure 4A-88: Inverting Waveform Data State	4A-122
Figure 4A-89: Copying Lines	4A-123
Figure 4A-90: Exchanging Lines	4A-124
Figure 4A-91: Expanding Waveform Data	4A-126
Figure 4A-92: Shift Register Configuration Menu	4A-127

Figure 4A-93: Register Values and Taps	4A-128
Figure 4A-94: Sample Settings for Register Values and Taps	4A-129
Figure 4A-95: Table Display	4A-133
Figure 4A-96: Waveform Editor Table Display Menu Structure	4A-134
Figure 4A-97: Table Display Screen	4A-136
Figure 4A-98: Numeric Displays for Waveform Data	4A-139
Figure 4A-99: Example of Equation File Data and Resulting Waveform	4A-141
Figure 4A-100: Equation Editor Menu Structure	4A-143
Figure 4A-101: Equation Editor CRT Display	4A-145
Figure 4A-102: Menu With Operation Selected	4A-147
Figure 4A-103: Component Menu	4A-149
Figure 4A-104: Trigonometric Function Waveform Expressed With Variable x	4A-151
Figure 4A-105: Trigonometric Function Waveform Expressed With Variable t	4A-152
Figure 4A-106: Equation Using exp(.....	4A-152
Figure 4A-107: Equation Using log(.....	4A-153
Figure 4A-108: Equation Using ln(.....	4A-153
Figure 4A-109: Equation Using sqrt(.....	4A-154
Figure 4A-110: Equation Using abs(.....	4A-154
Figure 4A-111: Equation Using int(.....	4A-155
Figure 4A-112: Equation Using round(.....	4A-155
Figure 4A-113: Equation Using norm(.....	4A-156
Figure 4A-114: Equation Using max(and min(.....	4A-157
Figure 4A-115: Equation Using rnd(.....	4A-157
Figure 4A-116: Waveform Before Calculation	4A-158
Figure 4A-117: Waveform After Differentiation Using diff(.....	4A-158
Figure 4A-118: Waveform After Integration Using integ(.....	4A-159
Figure 4A-119: Menu Displayed When Insert Other Equation is Selected	4A-161
Figure 4A-120: Setting Waveform Point Size	4A-162
Figure 4A-121: Example of Compiled Waveform Display	4A-163
Figure 4A-122: Sequence File Data and Sample Waveform Display	4A-165
Figure 4A-123: Sequence Editor Menu Structure	4A-167
Figure 4A-124: Sequence Editor CRT Display	4A-168
Figure 4A-125: Sequence File Creation Example	4A-171
Figure 4A-126: Example of Waveform Display When Show Catalog Entry is Selected	4A-173
Figure 4A-127: Example of CRT Display When Show Overview is Selected	4A-175
Figure 4A-128: Autostep File Data and Output Waveforms	4A-176
Figure 4A-129: Autostep Editor Menu Structure	4A-178
Figure 4A-130: Autostep Editor CRT Display	4A-180
Figure 4A-131: Selecting the Item for File Setting	4A-182
Figure 4A-132: File Selection List	4A-182
Figure 4A-133: Sample File Waveform Display	4A-183
Figure 4A-134: Setting a File	4A-183
Figure 4A-135: Clock Setting Menu	4A-185

Figure 4A-136: Filter Setting Menu	4A-186
Figure 4A-137: Amplitude Setting Menu	4A-187
Figure 4A-138: Offset Setting Menu	4A-188
Figure 4A-139: Marker Setting Menu	4A-189
Figure 4A-140: Split/Join Waveform Editor Menu Structure	4A-193
Figure 4A-141: Split/Join Waveform Editor CRT Display	4A-195
Figure 4A-142: File List	4A-197
Figure 4A-143: Point Sizes After Splitting Waveform File	4A-198
Figure 4A-144: Waveform File Data Before and After Copy/Cut	4A-200
Figure 4A-145: Waveform File Data Before and After Insertion	4A-201
Figure 4A-146: Convolution Waveform Editor Menu Structure	4A-203
Figure 4A-147: Convolution Waveform Editor CRT Display	4A-204
Figure 4A-148: Selecting a Waveform File	4A-205
Figure 4A-149: Sample Convolution	4A-206
Figure 4A-150: Sample Correlation	4A-207
Figure 4A-151: FFT Window Selection Menu	4A-209
Figure 4A-152: FFT Editor Menu Structure	4A-210
Figure 4A-153: FFT Editor CRT Display	4A-212
Figure 4A-154: Menu Displayed When Draw... is Selected	4A-216
Figure 4A-155: Drawing a Magnitude	4A-217
Figure 4A-156: Magnified Signal Display	4A-218
Figure 4A-157: Low Pass Filter	4A-219
Figure 4A-158: High Pass Filter	4A-219
Figure 4A-159: Band Pass Filter	4A-220
Figure 4A-160: Band Cut Filter	4A-220
Figure 4A-161: Fundamental, Odd, and Even Components	4A-222
Figure 4B-1: SETUP Menu Structure	4B-2
Figure 4B-2: SETUP Menu (Graphic Mode)	4B-3
Figure 4B-3: SETUP Menu (Text Mode)	4B-5
Figure 4B-4: Adding Data	4B-8
Figure 4B-5: Waveform Memory Divisions	4B-9
Figure 4B-6: Clock and Waveform Points	4B-10
Figure 4B-7: Amplitude and Offset Setting	4B-12
Figure 4C-1: MODE Menu Structure	4C-2
Figure 4C-2: MODE Menu CRT Display	4C-4
Figure 4C-3: Output for External Trigger Signal in Triggered Mode ..	4C-7
Figure 4C-4: Output for External Gate Signal in Gated Mode	4C-8
Figure 4C-5: Output for External Trigger Signal in Burst Mode	4C-10
Figure 4C-6: Output for External Trigger Signal (Hardware Sequencer Off)	4C-12
Figure 4C-7: Output for External Trigger Signal (Hardware Sequencer On)	4C-13
Figure 4C-8: Output for External Trigger Signal (Hardware Sequencer On)	4C-14
Figure 4C-9: Autostep File List	4C-16
Figure 4C-10: Output in Response to External Trigger Signal (when Run is set to Continuous and Step)	4C-18
Figure 4C-11: Slope and Level Controls	4C-19

Figure 4C-12: AWG2041 Synchronous Operation	4C-20
Figure 4D-1: Relationship Between Memory and Execution of Load/Save	4D-2
Figure 4D-2: LOAD/SAVE Menu Structure	4D-3
Figure 4D-3: LOAD Menu CRT Screen Display	4D-4
Figure 4D-4: LOAD Menu	4D-8
Figure 4D-5: SAVE Menu	4D-10
Figure 4D-6: Connecting Instruments	4D-12
Figure 4D-7: GPIB Source List	4D-13
Figure 4D-8: List of Supported Models Made by Other Manufacturers	4D-14
Figure 4E-1: UTILITY Menu Structure	4E-2
Figure 4E-2: Format... Sub-Menu Display	4E-5
Figure 4E-3: Write Protect Tab on a Floppy Disk	4E-7
Figure 4E-4: File and Directory Display in the Root Directory	4E-9
Figure 4E-5: Directory Name Input	4E-10
Figure 4E-6: Directory Displayed When Change Directory is Selected	4E-10
Figure 4E-7: File List for a Newly Created Directory	4E-11
Figure 4E-8: Menu Displayed When NVRam is Selected	4E-12
Figure 4E-9: Menu Displayed When GPIB is Selected	4E-13
Figure 4E-10: Menu Displayed When RS232C is Selected	4E-15
Figure 4E-11: Menu Displayed When Date Time is Selected	4E-17
Figure 4E-12: Setting the Display Brightness	4E-19
Figure 4E-13: Menu Displayed when Catalog Order is Selected	4E-20
Figure 4E-14: Catalog Files	4E-20
Figure 4E-15: Catalog With Files Displayed in Type4 Format	4E-22
Figure 4E-16: Date/Time Display	4E-22
Figure 4E-17: Message for Changing Hardware Sequencer	4E-25
Figure 4E-18: Format Selection Menu	4E-26
Figure 4E-19: Port Selection Menu	4E-27
Figure 4E-20: Display When System is Selected	4E-29
Figure 4E-21: I/O Event Reporting	4E-30
Figure 4E-22: Diagnostics List	4E-31
Figure 4E-23: Calibration List	4E-33
Figure 4F-1: FG Mode Menu Structure	4F-2
Figure 4F-2: FG Mode Menu Display	4F-3
Figure 4F-3: Setting the Amplitude	4F-5
Figure 4F-4: Setting the Offset	4F-5
Figure 4F-5: Waveform Polarity	4F-6
Figure 4F-6: Setting the Duty Value for a Pulse Wave	4F-6
Figure A-1: Digital Output Connectors	A-2
Figure B-1: Trigger Delay	B-10
Figure C-1: Gaussian Pulse Formula and Waveform	C-2
Figure C-2: Lorentz Pulse Formula and Waveform	C-3
Figure C-3: Sampling Function SIN(X)/X Pulse Formula and Waveform	C-4

Figure C-4: Squared Sine Pulse Formula and Waveform	C-5
Figure C-5: Double Exponential Pulse Formula and Waveform	C-6
Figure C-6: Nyquist Pulse Formula and Waveform	C-7
Figure C-7: Linear Frequency Sweep Formula and Waveform	C-8
Figure C-8: Log Frequency Sweep Formula and Waveform	C-9
Figure C-9: Amplitude Modulation Formula and Waveform	C-10
Figure C-10: Frequency Modulation Formula and Waveform	C-11
Figure C-11: Pulse Width Modulation Waveform	C-12
Figure C-12: Pseudo-Random Pulse Waveform	C-13
Figure C-13: Waveform for Magnetic Disk Writing Signal	C-14
Figure C-14: Waveform for Magnetic Disk Readout	C-15
Figure D-1: Linear Interpolation	D-1
Figure D-2: Point Padding	D-2
Figure D-3: Point Compression	D-2
Figure D-4: Equation Differentiation	D-3
Figure D-5: Equation Integration	D-4
Figure D-6: Phase and Delay	D-14
Figure D-7: Concept of Convolution	D-15
Figure D-8: Square Window and Frequency Characteristic	D-16
Figure D-9: Hanning Window and Frequency Characteristic	D-16
Figure D-10: Hamming Window and Frequency Characteristic	D-17
Figure D-11: Blackman-Harris Window and Frequency Characteristic	D-17
Figure D-12: Blackman Window and Frequency Characteristic	D-18
Figure D-13: Triangle Window and Frequency Characteristic	D-18
Figure E-1: Diagnostics Menu	E-4
Figure E-2: Calibration Menu	E-5
Figure E-3: LOAD Menu	E-10
Figure E-4: Cont Mode Initial Test Hookup	E-13
Figure E-5: Triggered Mode Initial Test Hookup	E-15
Figure E-6: Gated Mode Initial Test Hookup	E-17
Figure E-7: Relationship between 1 Volt or Greater Gate Signal and Waveform Output Signal	E-18
Figure E-8: Burst Mode Initial Test Hookup	E-19
Figure E-9: Waveform Advance Mode Initial Test Hookup	E-21
Figure E-10: Waveform Advance Mode Initial Test Hookup	E-22
Figure E-11: Autostep Mode Initial Test Hookup	E-24
Figure E-12: Slave Mode Initial Test Hookup	E-27
Figure E-13: Clock Frequency Accuracy Initial Test Hookup	E-29
Figure E-14: Amplitude Accuracy Initial Test Hookup	E-31
Figure E-15: Pulse Response Initial Test Hookup	E-34
Figure E-16: Sine Wave Initial Test Hookup	E-36
Figure E-17: Marker Level Initial Test Hookup	E-38
Figure E-18: Marker Waveform Initial Test Hookup	E-40
Figure E-19: SYNC Delay Initial Test Hookup	E-42
Figure E-20: Trigger Input Initial Test Hookup	E-44
Figure E-21: Trigger to Marker Delay Initial Test Hookup	E-46

Figure E-22: External CLOCK IN Initial Test Hookup	E-48
Figure E-23: Digital Data Out Initial Test Hookup	E-50

List of Tables

Table 2-1: Numeric Value Input Example 1	2-18
Table 2-2: Numeric Value Input Example 2	2-19
Table 3-1: Sample Sequence Files	3-13
Table 4A-1: Menu Functions	4A-4
Table 4A-2: Menu Functions	4A-29
Table 4A-3: Differences Between the Shift Operations	4A-74
Table 4A-4: Menu Functions	4A-103
Table 4A-5: Menu Functions	4A-135
Table 4A-6: Menu Functions	4A-144
Table 4A-7: Menu Functions	4A-167
Table 4A-8: Menu Functions	4A-179
Table 4A-9: Menu Functions	4A-194
Table 4A-10: Menu Functions	4A-203
Table 4A-11: Menu Functions	4A-211
Table 4B-1: Menu Functions	4B-3
Table 4C-1: Menu Functions	4C-3
Table 4D-1: Menu Functions	4D-3
Table 4D-2: Supported Instruments	4D-7
Table 4D-3: Supported Floppy Disk Files	4D-16
Table 4E-1: Menu Functions	4E-3
Table 4E-2: MS-DOS Formats for 3.5-inch Disks	4E-6
Table 4E-3: Format Extensions	4E-27
Table 4F-1: Frequency, Waveform and Marker Signal Data Point Count	4F-2
Table A-1: Power Cord Options	A-3
Table D-1: Factory Settings	D-20
Table E-1: Test Equipment	E-8
Table E-2: Additional Test Equipment for Optional Check (Slave Mode)	E-9
Table E-3: Additional Test Equipment for Option 03	E-9
Table E-4: File List for Performance Check/Adjustment Disk	E-11

General Safety Summary

Review the following safety precautions to avoid injury and prevent damage to this product or any products connected to it.

Only qualified personnel should perform service procedures.

Injury Precautions

Use Proper Power Cord

To avoid fire hazard, use only the power cord specified for this product.

Avoid Electric Overload

To avoid electric shock or fire hazard, do not apply a voltage to a terminal that is outside the range specified for that terminal.

Ground the Product

This product is grounded through the grounding conductor of the power cord. To avoid electric shock, the grounding conductor must be connected to earth ground. Before making connections to the input or output terminals of the product, ensure that the product is properly grounded.

Do Not Operate Without Covers

To avoid electric shock or fire hazard, do not operate this product with covers or panels removed.

Use Proper Fuse

To avoid fire hazard, use only the fuse type and rating specified for this product.

General Safety Summary

Do Not Operate in Wet/Damp Conditions

To avoid electric shock, do not operate this product in wet or damp conditions.

Do Not Operate in Explosive Atmosphere

To avoid injury or fire hazard, do not operate this product in an explosive atmosphere.

Product Damage Precautions

Use Proper Power Source

Do not operate this product from a power source that applies more than the voltage specified.

Provide Proper Ventilation

To prevent product overheating, provide proper ventilation.

Do Not Operate With Suspected Failures

If you suspect there is damage to this product, have it inspected by qualified service personnel.

Safety Terms and Symbols

Terms in This Manual These terms may appear in this manual:



WARNING. *Warning statements identify conditions or practices that could result in injury or loss of life.*



CAUTION. *Caution statements identify conditions or practices that could result in damage to this product or other property.*

Terms on the Product These terms may appear on the product:

DANGER indicates an injury hazard immediately accessible as you read the marking.

WARNING indicates an injury hazard not immediately accessible as you read the marking.

CAUTION indicates a hazard to property including the product.

Symbols on the Product

The following symbols may appear on the product:



DANGER
High Voltage



Protective Ground
(Earth) Terminal



ATTENTION
Refer to
Manual



Double
Insulated

Certifications and Compliances

CSA Certified Power Cords

CSA Certification includes the products and power cords appropriate for use in the North America power network. All other power cords supplied are approved for the country of use.

Welcome

This is the User Manual for the AWG2041 Arbitrary Waveform Generator.

Section 1 Getting Started covers the features of the AWG2041 initial inspection, and start up. In particular, the start up section covers the procedures required prior to turning on the unit and points that require special care or caution. Be sure to read this section carefully.

Section 2 Operating Basics first describes the components of the AWG2041 and their functions. Then it describes the operating procedures used to output waveforms from the AWG2041 by presenting a few simple examples.

Section 3 Functional Operation Summary presents a basic operational overview of the AWG2041

Section 4 Reference explains the specific functions and execution method details for each menu.

Appendices describe option and accessories, specifications, sample waveform library, performance verification, and various miscellaneous subjects.

Related Manuals

Other documentation for the instrument includes:

- The AWG2000 Series Programmer Manual (Tektronix part number 070-8657-XX) explains how to control the AWG2041 with a computer through the GPIB or RS-232-C interface. This manual is a standard accessory.
- The AWG2041 Service Manual (Tektronix part number 070-9457-XX) provides information to maintain and service AWG2041, and provides a complete board-level description of the instrument's operation. This manual is an optional accessory.

Conventions

In sections 2 through 4, you will find various procedures that contain steps of instructions for you to perform. To keep those instructions clear and consistent, this manual uses the following conventions:

- Names of front panel controls and menu item names are printed in the manual in bold with the same case (e.g., initial capitals, all upper case) as they appear on the unit itself.
- Instruction steps are numbered. When the number is omitted there is only one step.
- When menu items are displayed in the manual, the menu type, either bottom menu, side menu, or sub-menu, is distinguished and indicated as shown below.



Bottom Menu



Side Menu or Sub-Menu

- Consecutive button operations are expressed as shown below.

Setting (bottom) → **View type...** (side) → **Timing** (sub)

This expression describes the following button operations.

- 1) Selecting the "**Setting**" item from the bottom menu
- 2) Selecting the "**View type...**" item from the side menu.
- 3) Selecting the "**Timing**" item from the sub-menu.

Trademarks

Epson is a registered trademark of Epson America, Inc.

IBM is a registered trademark of International Business Machines.

PC9800 is a trademark of NEC Corporation.

J3100 is a trademark of Toshiba Corporation.

MS-DOS and Windows are registered trademarks of Microsoft Corporation.

Postscript is a registered trademark of Adobe Systems Incorporated.

Getting Started

Overview

This section describes the features of the AWG2041, initial inspection, and start up.

Product Description

The AWG2041 is a portable arbitrary waveform generator equipped with a differential output channel and capable of generating both arbitrary and standard function waveforms.

This arbitrary waveform generator provides these major features:

- custom waveforms for simulation and testing
- waveforms that can not be generated with function generators

As an arbitrary waveform generator, the AWG2041 has a clock frequency of 1 GHz, an 8-bit DA converter and a 1M-word waveform memory (or 4M-word memory when Option 01 is installed) for high-quality waveform generation and differential output to one channel. It can also generate a two-channel arbitrary marker output to accompany waveform output.

The AWG2041 also has a digital out function (when Option 03 is installed) for direct output of the digital data for the arbitrary waveform in the waveform memory, without going through the D/A converter.

This instrument has four editors for making waveform files. Each editor is equipped with a variety of editing functions, as described below.

1. Waveform Editor – creates waveform data. This editor can display its data in three formats: graphical, table, and timing, and the data can be edited in the format appropriate for the application. Furthermore, the waveform editor can edit up to three waveform files at the same time, thus easing the creation of related waveform files.
2. Sequence Editor – creates sequences of waveforms by combining waveform files created with the waveform editor.
3. Equation Editor – creates files with equations and compiles them into waveform files.
4. Autostep Editor – programs waveform files, including output conditions, in steps.

An FFT editor, a convolution waveform editor and a split/join editor are provided with AWG2041 units that include Option 09. These editors support frequency domain editing, convolution calculations and split/join of the waveform file data.

As a function generator, this instrument can generate sine waves, triangle waves, square waves, ramp waves, and pulse waves. It can set the frequency, amplitude, offset, polarity, and other factors for each of these waveforms.

The AWG2041 has a 3.5-inch floppy disk drive and non-volatile memory for storing created waveform data and parameter settings. Each of these storage devices can store the files created with the editors.

You control this instrument by way of its front panel hierarchical menu display system or its rear panel GPIB or RS-232-C interfaces. Waveforms can be transferred directly through the GPIB interface from a digital storage oscilloscope. Such direct waveform transfers allow for many types of applications with other measurement equipment and computers. Supported equipment includes our major digital storage oscilloscopes as well as the digital storage oscilloscopes of other leading manufacturers.

Initial Inspection

Before unpacking the AWG2041 from its shipping carton, inspect it for signs of external damage. If the carton is damaged, notify the carrier. The carton contains the basic instrument and its standard accessories. Refer to the Standard Accessories list in Appendix A.

This instrument was thoroughly inspected for mechanical and electrical defects before shipment. It should be free of marks or scratches and meet or exceed all electrical specifications. To confirm this, inspect the instrument for physical damage incurred in transit and test the electrical performance by following the Performance Check section of the Service Manual. If a discrepancy is found, contact your local Tektronix Field Office or representative.

NOTE. *At installation time, save the shipping carton and packaging materials for repackaging in case shipment becomes necessary.*

Start Up

This section describes the procedures required prior to turning on the AWG2041.

Installation

Before you begin, refer to the Operator's Safety Summary at the front of this manual for power source, grounding, and other safety information.

Before you use the instrument, ensure that it is properly installed and powered on. To properly install and power on the instrument, perform the following steps:

- Step 1:** Check that the operating environment is correct.

The AWG2041 operates correctly in ambient temperatures from +10°C to +40°C and relative humidity from 20% to 80%. If this instrument is stored at temperatures outside this usage temperature range, do not switch on the power until the chassis has come within the usage temperature range. For the information on the other operating environment, see Appendix B "Performance Characteristics."

NOTE. If you are installing this instrument in the dedicated rack, refer to the instruction sheet that comes with the rack mounting kit.

- Step 2:** Before switching on the power, double check that there is nothing blocking the flow of air at the fan and air intake holes.

This instrument takes in outside air and cools itself by forcibly exhausting air with the fan on its left side. Leave space at the sides of this instrument so that the heat generated within the instrument does not build up and harm the operation. There are holes for air intake on the sides and bottom of this cabinet. After switching on the power, double check that the fan is turning. Here are the minimums for the space at the sides of this instrument.

Top and rear 3 inches

Left and right 6 inches



WARNING. Always unplug the power cord from the socket before checking the line fuse to avoid electrical shock.

- Step 3:** Remove the fuse from the fuse holder on the rear panel and check the fuse.

To remove the fuse, turn it counter-clockwise with a screwdriver while pushing it in. See Figure 1-1 for the fuse location. There are two types of fuses that may be used. Here are the fuse types and ratings.

Fuse	Fuse Part Number	Fuse Cap Part Number
25 inch x 1.25 inch (UL 198G,3AG): 6A FAST, 250 V.	159-0239-00	200-2264-00
5 mm x 20 mm (IEC 127):5A (T), 250 V.	159-0210-00	200-2265-00

- Step 4:** Check that you have the proper electrical connections. The AWG2041 operates at the following power supply voltage.

Line Voltage Range	90 V – 250 V
Line Frequency	48 Hz – 440 Hz (90 V – 127 V) 48 Hz – 63 Hz (127 V – 250 V)
Maximum Power	300 W



CAUTION. Instruments are shipped with a power cord appropriate for use with normal 115 V power systems. If the AWG2041 is to be used with 230 V power it must be replaced with one appropriate for the power source used. See Figure 1-2, "Optional Power Cords", for the available power cord types.

- Step 5:** Connect the proper power cord from the rear-panel power connector to the power system.

Power On

- Step 6:** Push the **PRINCIPAL POWER SWITCH** (shown in Figure 1-1) on the rear panel of this instrument. Power is now applied to the standby circuit of this instrument.

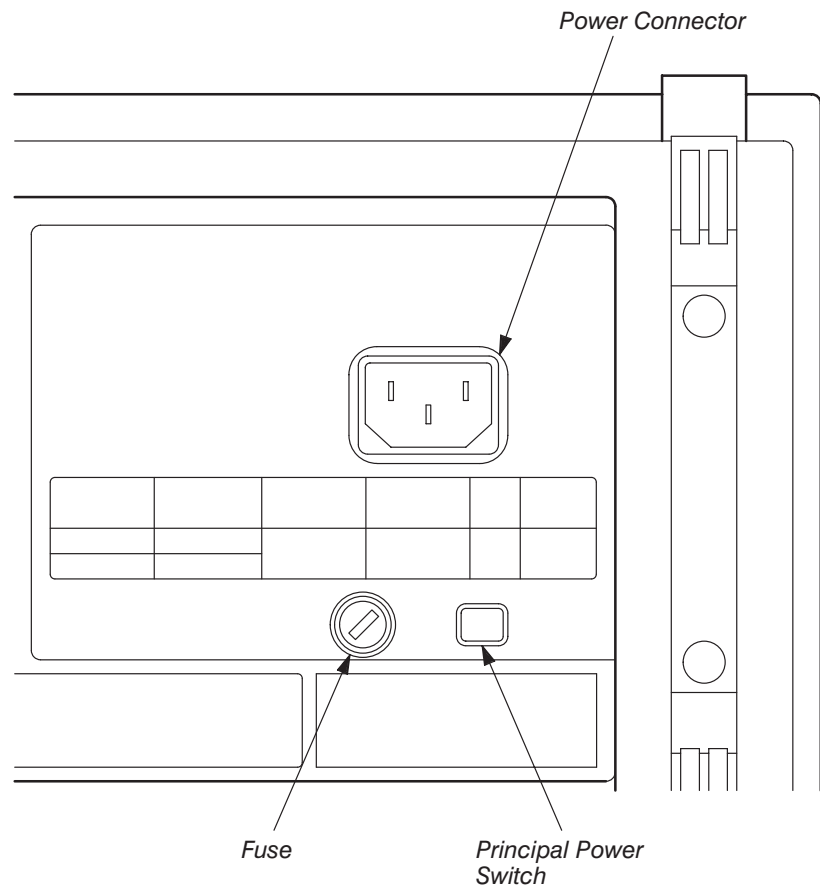
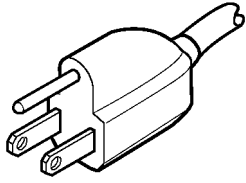
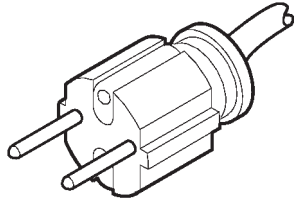

Figure 1-1: Rear Panel Controls Used In Start Up

Start Up



Standard*
North American
115V



Option A1
Universal Euro
230V

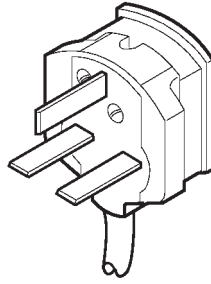

Option A2
UK
230V

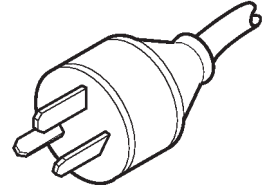

Option A3
Australian
230V

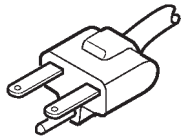

Option A4*
North American
230V

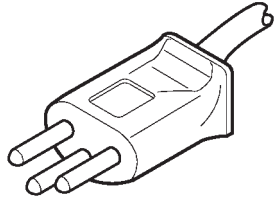

Option A5
Switzerland
230V

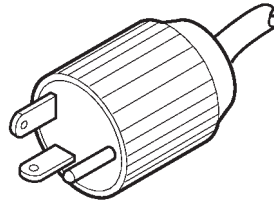

Option 1A*
North American
115V/High Power

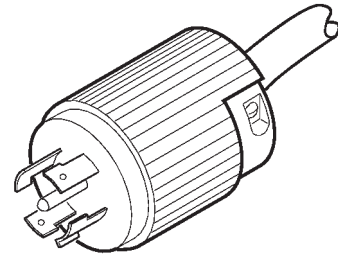

Option 1B
North American
3-Phase

** Canadian Standards Association certification includes these power plugs for use in the North American power network*

Figure 1-2: Optional Power Cords

- **Step 7:** Press the **ON/STBY** switch (shown in Figure 1-3) on the lower left side of the front panel to switch on the power for this instrument.

This instrument needs to be warmed up for at least 20 minutes in order to operate at its optimum precision.

Once this instrument is installed, it is typical to leave the **PRINCIPAL POWER SWITCH** on and use the **ON/STBY** switch as the power switch.

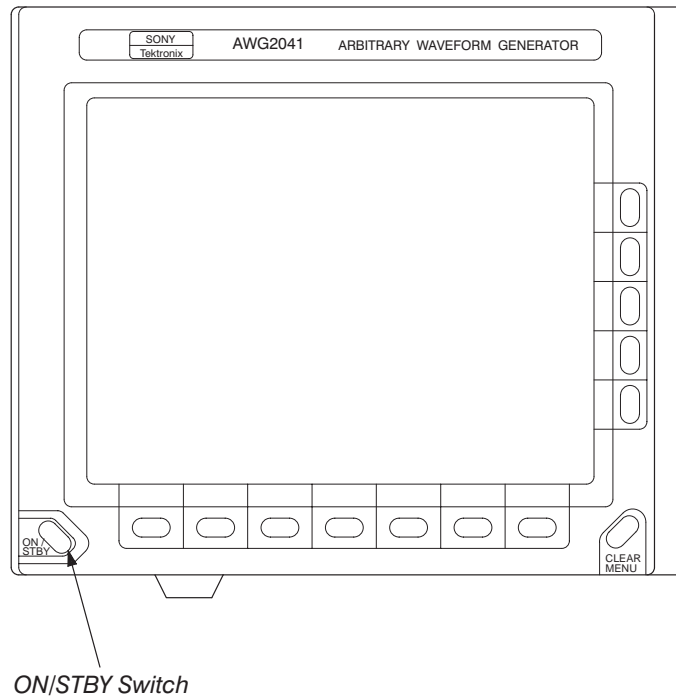

Figure 1-3: ON/STBY Switch

Start-up Diagnostics/ Calibrations

- Step 8:** Check the results of the start-up diagnostics/calibrations.

When the power is applied to this instrument, the start-up diagnostics and calibration are carried out. It checks whether the instrument is performing within its defined operating characteristics.

If all the diagnostic/calibration items are completed without error, **Pass** is displayed and the system moves on to the **SETUP** menu.

If an error is detected, **Fail** and the error code are displayed. You can exit this state and operate this instrument, but until the error is corrected, the waveform outputs can not be relied on. If an error is detected, contact our nearest representative. To exit the diagnostics/calibration system, press any of the buttons. The system moves on to the **SETUP** menu.

NOTE. *When the power is switched on, this instrument is calibrated, but in order to preserve the precision of this instrument, after the completion of the warm-up or temperature changes, recalibrate this instrument. For details on how to calibrate, see the explanation of the **Calibration** item on the **UTILITY** menu in Section 4A.*

If this instrument is exposed to temperatures outside its usage temperature range and the chassis temperature is inappropriate, an error will occur during the calibration when the power is switched on. If this happens, wait till the chassis temperature is appropriate, then switch the power on again.

Power Off

- Step 9:** Toggle the **ON/STBY** switch.

Operating Basics

Introduction

This section will discuss the following:

- **Overview**

The names of the parts of the instrument and their functions.

- **Basic Menu Operation**

Operations commonly performed on the instrument and how to enter numbers.

- **Operating Examples**

Simple examples showing how to output waveforms.

These examples are designed to help you gain a basic understanding of the instrument.

Overview

The instrument can be divided into three main areas: the front panel, the rear panel and the side panel. In this section, we will list the names and functions of the parts in each of these areas. We will also list typical display messages that appear on the screen and what they mean.

Front Panel

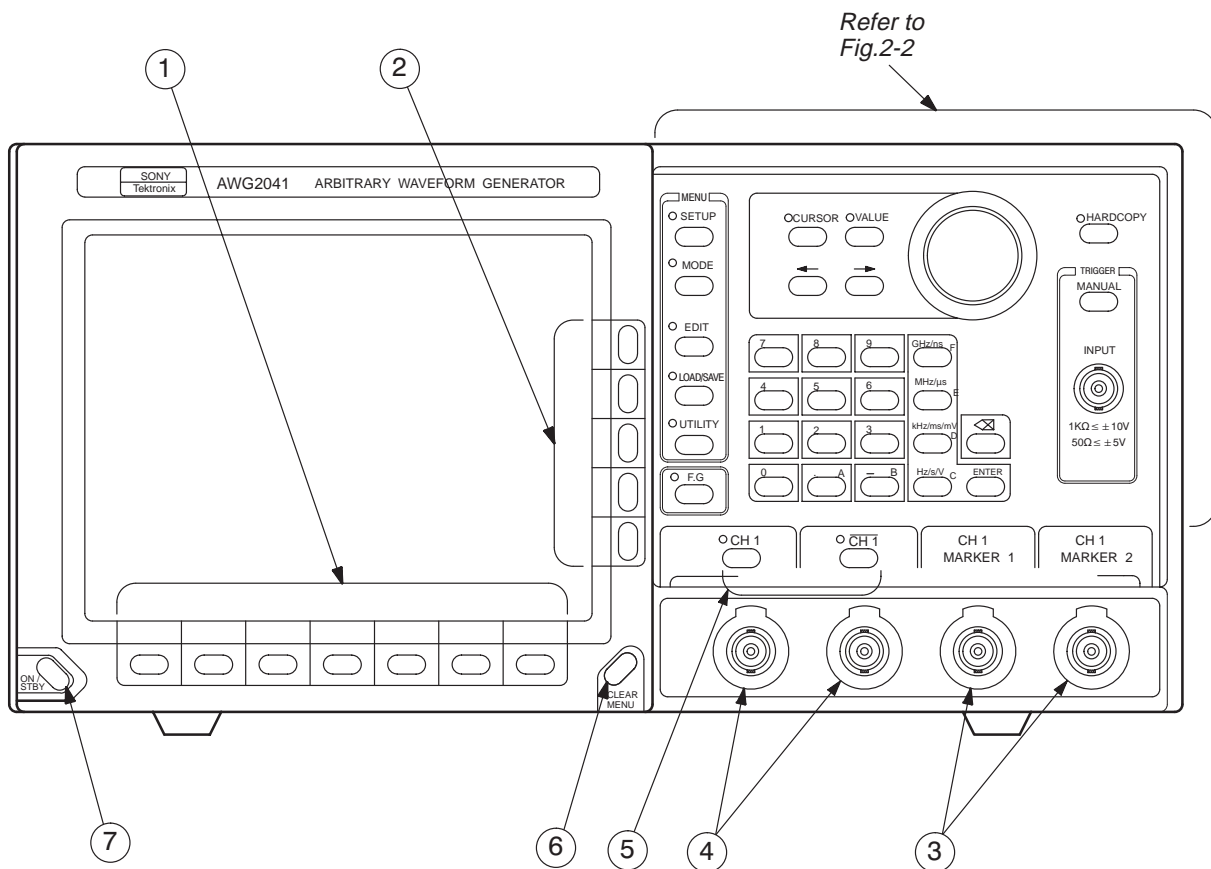

Figure 2-1: Front Panel Overall View

(1) Bottom Buttons

Use the seven bottom buttons to display corresponding menus. Pressing any button in the **MENU** column, or the **F.G** button, displays its corresponding menu. These menus are generally the highest level menus.

(2) Side Buttons

Use the five side buttons to select the side menu displayed on the right side of the screen. Selecting any item from bottom menu displays a side menu. The side menu is generally a lower level menu.

(3) MARKER 1 and MARKER 2 Output Connectors

These provide the user-specified marker signals. The maximum output level is ± 2 V with a 50Ω termination.

(4) CH1 Waveform Output Connector

Provides the normal waveform output from the CH1 connector and the inverted waveform output from the $\overline{\text{CH1}}$ connector. The maximum output level is ± 2 V with a 50Ω termination.



CAUTION. Do not apply any external voltage to the output connector of this instrument. Doing so can harm this instrument.

(5) Waveform Output On/Off Buttons and Indicators

Press the waveform output on/off buttons to switch the output on and off. When set to on, the LED indicator is lit and a waveform is output. When set to off, the LED indicator is extinguished and a waveform is not output.

(6) CLEAR MENU Button

Press this button to cancel any entering alphanumeric input and return the system to the data before input. Also, for a side menu item with "...” attached to it, pressing this button returns the system from the sub menu (lower-level menu) to the side menu. Using remote commands, the user may delete a message that has been entered in the message area (see page 2-14).

(7) ON/STBY Button

When the principal power switch on the rear panel has been pressed to supply power to the standby circuit, this button can be pressed to provide power to the other circuits of the instrument. Normally this button is used as a power switch.

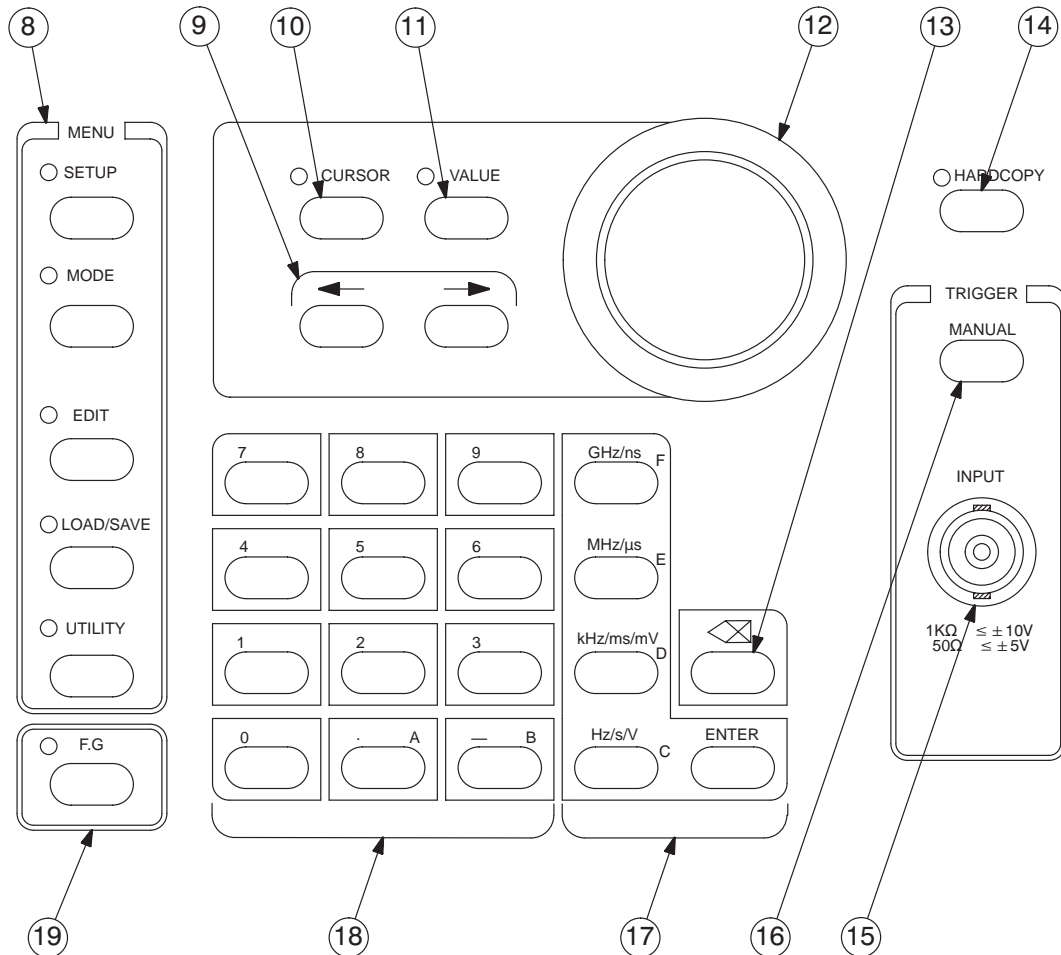

Figure 2-2: Front Panel Button Detail

(8) Menu Buttons and Indicators

The **MENU** column comprises the **SETUP**, **MODE**, **EDIT**, **LOAD/SAVE** and **UTILITY** buttons. To display one of these five main menus on the screen, press the corresponding button in the MENU column. The corresponding LED indicators show which menu has been selected. Each of these menus is described in detail in Section 4A through 4F.

SETUP Menu

Use the **SETUP** menu to set the following waveform output parameters : clock source and frequency, waveform/sequence file selection, filter, amplitude, offset and marker level. See Section 4B for more information.

MODE Menu

Use the **MODE** menu to set the operating mode. Operating modes consist of trigger modes (**Cont**, **Triggered**, **Gated** and **Burst**); **Waveform Advance**, in which waveform output is performed for a sequence file in response to each trigger signal; and **Autostep**, in which the next waveform is set for output in response to an autostep signal. In addition to these modes, there is also an item equipped switch the system to the slave operation. See Section 4C for more information.

EDIT Menu

The **EDIT** menu incorporates four types of editors: the waveform editor, the equation editor, the sequence editor and the autostep editor. This makes the AWG2041 perform editing according to the types of the files. Instruments with Option 09 installed have a FFT editor to permit editing in the frequency domain, a convolution editor to operate the waveform convolution in high speed, and a split/join editor to split or join the waveform file data.

The **EDIT** menu displays a list of files stored in internal memory. New files can be created or existing files can be selected from this list and edited. See Section 4A for further information.

LOAD/SAVE Menu

Press the **Load/Save** bottom button to select the appropriate menu. See Section 4D for further information.

LOAD Menu—Used when loading files from a floppy disk or non-volatile internal RAM (NVRam) into the internal memory of the AWG2041, or from another instrument through the GPIB interface.

SAVE Menu—Used when saving files from the internal memory of the AWG2041 to a floppy disk or to the instrument's NVRam.

UTILITY Menu

Use the **UTILITY** menu to operate on the files saved to a floppy disk or the instrument's NVRam; to set the parameters for the GPIB or RS-232-C interface; to execute diagnosis or calibration of the instrument. See Section 4E for further information.

(9) ← and → Buttons

Use the arrow buttons to shift to the right/left of the input digit or cursor that indicates the input position when a numeric value or character is input using the general purpose knob. The digit input numeric value is indicated at the underscore. Hold down these arrow buttons to shift in succession.

(10) CURSOR Button and Indicator

When the indicator is lit, the function assigned to the **CURSOR** button is operational. Use the **CURSOR** button to select a field or switch the active cursor. The function of **CURSOR** button is different depending on each menu. When a special function is assigned to the **CURSOR** button, a description of the **CURSOR** button is displayed on the screen.

(11) VALUE Button and Indicator

Press the **VALUE** button to light the LED indicator. In this state, inputting the numeric values or selecting the item can be done using the numeric keys or the general purpose knob. After inputting or selecting, press the **VALUE** button to enter the setting. When a special function is assigned to the **VALUE** button, an explanation of the **VALUE** button is displayed on the screen.

(12) General Purpose Knob

Use this knob to set a variety of functions and numerical values on the instrument. When a knob icon is displayed on the screen next to an item, it indicates that the item can be controlled.

(13) Delete Key

Use this key to delete the character just in front of the cursor. Hold down the key to delete characters in succession.

(14) HARDCOPY Button

Use this button to output a hard copy of the data displayed on the screen. The hard copy can be output to disk or to either the GPIB or RS-232-C interface.

(15) TRIGGER INPUT Connector

Use this connector to input of the external trigger or gate signal. This connector can accommodate an external signal input of up to ± 10 V with an input impedance of $1\text{ k}\Omega$ or up to ± 5 V with an input impedance of 50Ω .

(16) TRIGGER MANUAL Button

When the operation mode is set to **Triggered**, **Burst**, **Waveform Advance** or **Autostep**, pressing the **MANUAL** button will cause waveform output to begin. Waveform output will proceed and stop in accordance with the mode that has been set. In **Gated** mode, the waveform will be output only as long as the **MANUAL** button is pressed. In **Cont** mode, pressing the **MANUAL** button has no effect.

(17) Unit Keys and ENTER Key

The following unit keys are provided: **GHz/ns**, **MHz/μs**, **kHz/ms/mV** and **Hz/sec/V**. Press the appropriate unit key to specify the desired numeric value and unit. Also, if a hexadecimal radix is selected from the waveform editor table display, the unit key is used to input **C-F**. Press the **ENTER** key to enter the numeric value and selected item.

(18) Numeric Keys

Press the numeric keys to enter numeric data. The numeric keys include the numerals **0** through **9**, and the **."** and **"–"** symbols. The **."** and **"–"** numeric keys are also used to input hexadecimal **"A"** and **"B"**, respectively, in the waveform editor table display. Hold down a numeric key as desired to repeat its input.

(19) F.G Button

Press the **F.G** button to switch from arbitrary waveform generation mode to functional waveform generation mode. Use this mode to select one of the standard function waveforms for waveform output and to set its parameters. The functional waveforms include sine, triangular, square, ramp and pulse waveforms. You can set each function's parameters. See Section 4F for further information.

Side Panel

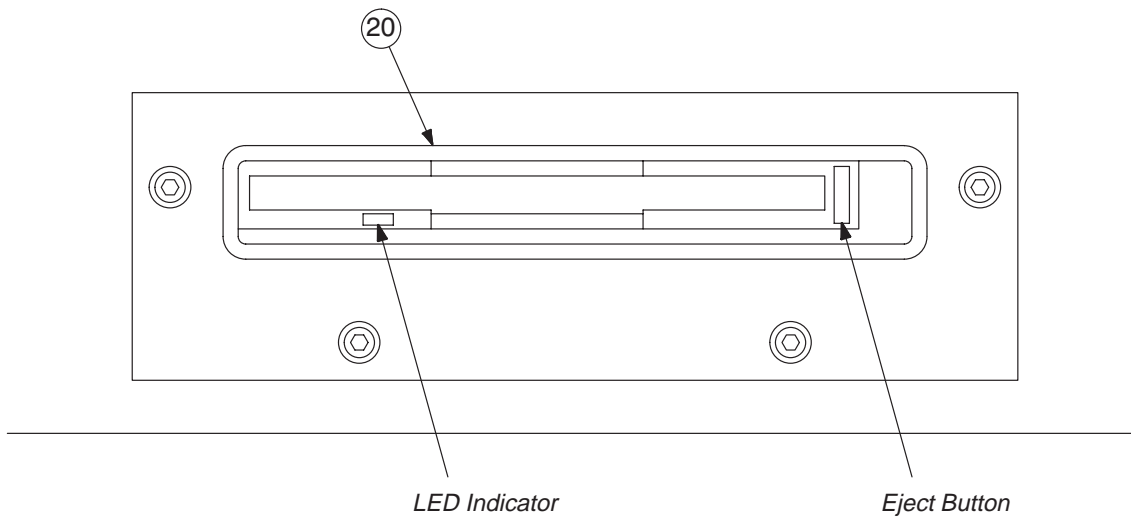

Figure 2-3: Side Panel

(20) Floppy Disk Drive

The floppy disk drive is used for saving and loading various types of files. Files can be loaded or saved from/to floppy disk using the **LOAD/SAVE** menu. When the disk drive is in operation, the LED indicator is lit. Remove a floppy disk by pressing the eject button.

NOTE. *Never press the eject button to eject the floppy disk while the disk drive indicator light is lit, as the stored data may be corrupted and errors may result.*

Rear Panel

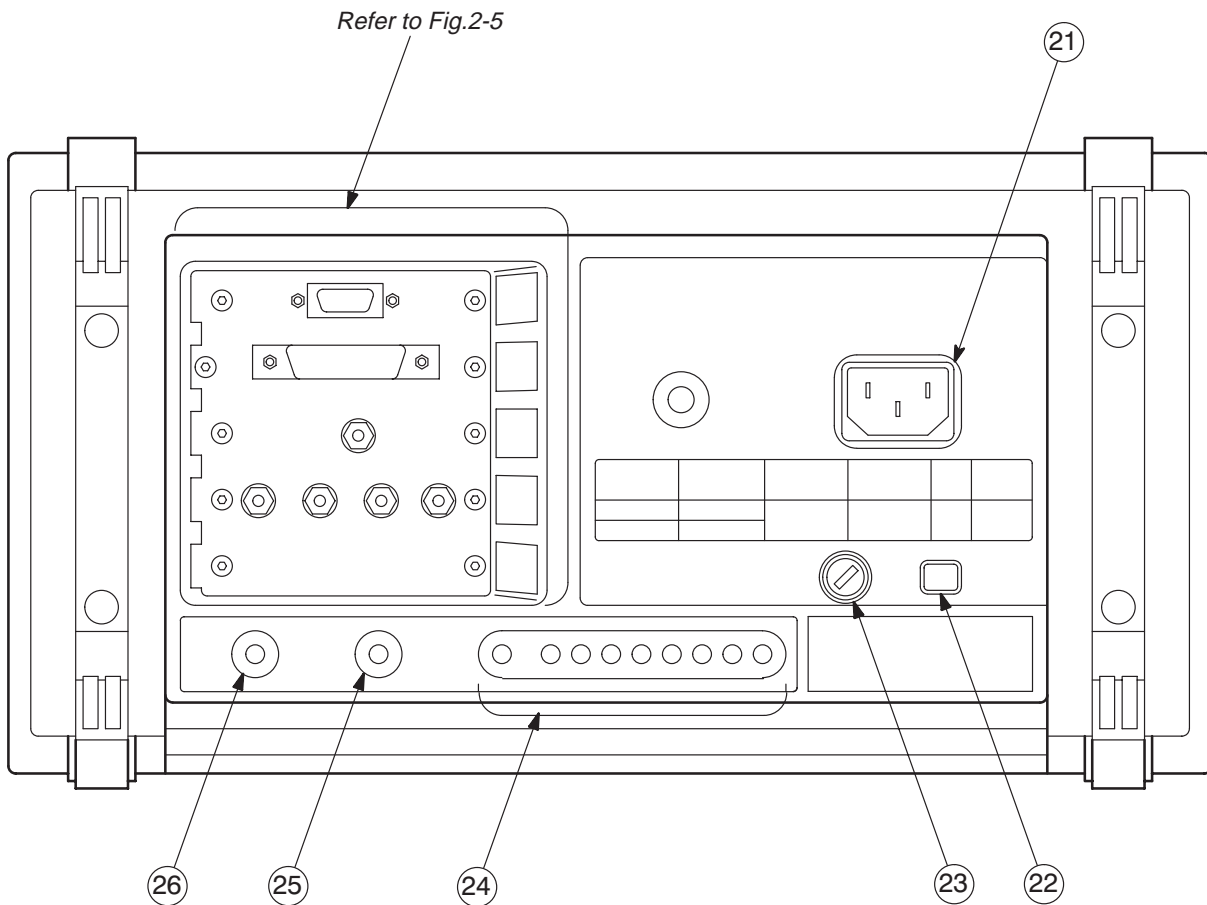

Figure 2-4: Rear Panel Overall View

(21) Power Source Connector

A power cord is connected to the power source connector.

(22) PRINCIPAL POWER SWITCH

When this switch is on, power is supplied to the standby circuit in the power system. Press the **ON/STBY** button on the front panel to supply power to the rest of the instrument.

(23) Fuse Holder

The power supply fuse is enclosed in the fuse holder. The same fuse is used for both 115 V and 230 V systems. A 6 A fast-blow fuse is used.

NOTE. When using the AWG2041 in Europe, you should use an IEC-approved fuse. For details, see Page 1-4.

(24) DIGITAL OUT Connector (Option 03)

This connector is used for output of the clock signal (ECL level) and the digital data (D0 – D7) for the waveform to be output. The output must be terminated to -2 V with a 50Ω termination.

(25) MASTER CLK OUT Connector

This connector is used for output of the master clock (ECL level). The output must be terminated to -2 V with a 50Ω termination.

(26) SLAVE CLK IN Connector

This connector is used for input of the slave clock (ECL level). The input is terminated to -2 V with a 50Ω termination.

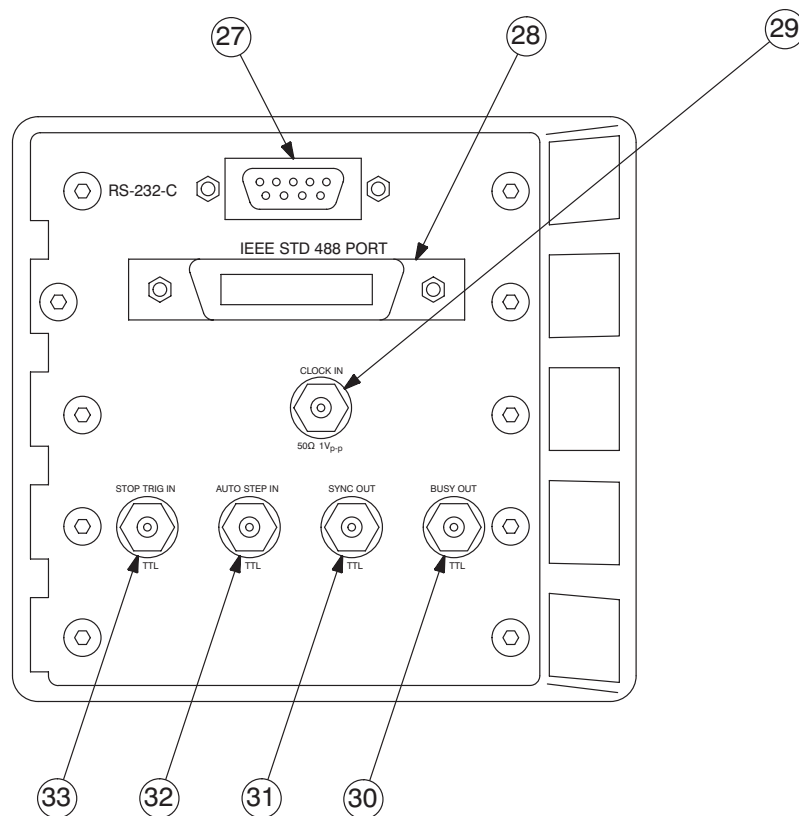

Figure 2-5: Rear Panel Detail

(27) RS-232-C Connector

The RS-232-C connector enables remote control by a computer via this serial interface.

(28) IEEE STD 488 Connector

The IEEE STD 488 connector enables remote control by a computer via an IEEE STD 488 parallel interface.

(29) CLK IN Connector

This connector is used for external clock input. It requires an external signal of up to 1 V_{p-p}.

(30) BUSY OUT Connector

This connector is used for output of a busy signal (TTL level). The busy signal is output while the CH1 waveform is being output. The output resistance is 51Ω.

(31) SYNC OUT Connector

This connector is used for output of a synchronous signal (TTL level). The synchronous signal is output at the starting point for CH1 waveform output. The output resistance is 51Ω.

(32) AUTO STEP IN Connector

This connector is used for input of an autostep signal (TTL level). In **Auto-step** mode, the autostep signal changes the waveform file currently being output to the next file.

(33) STOP TRIG IN Connector

This connector is used for input of the trigger signal (TTL level) used to stop waveform output.

CRT Display

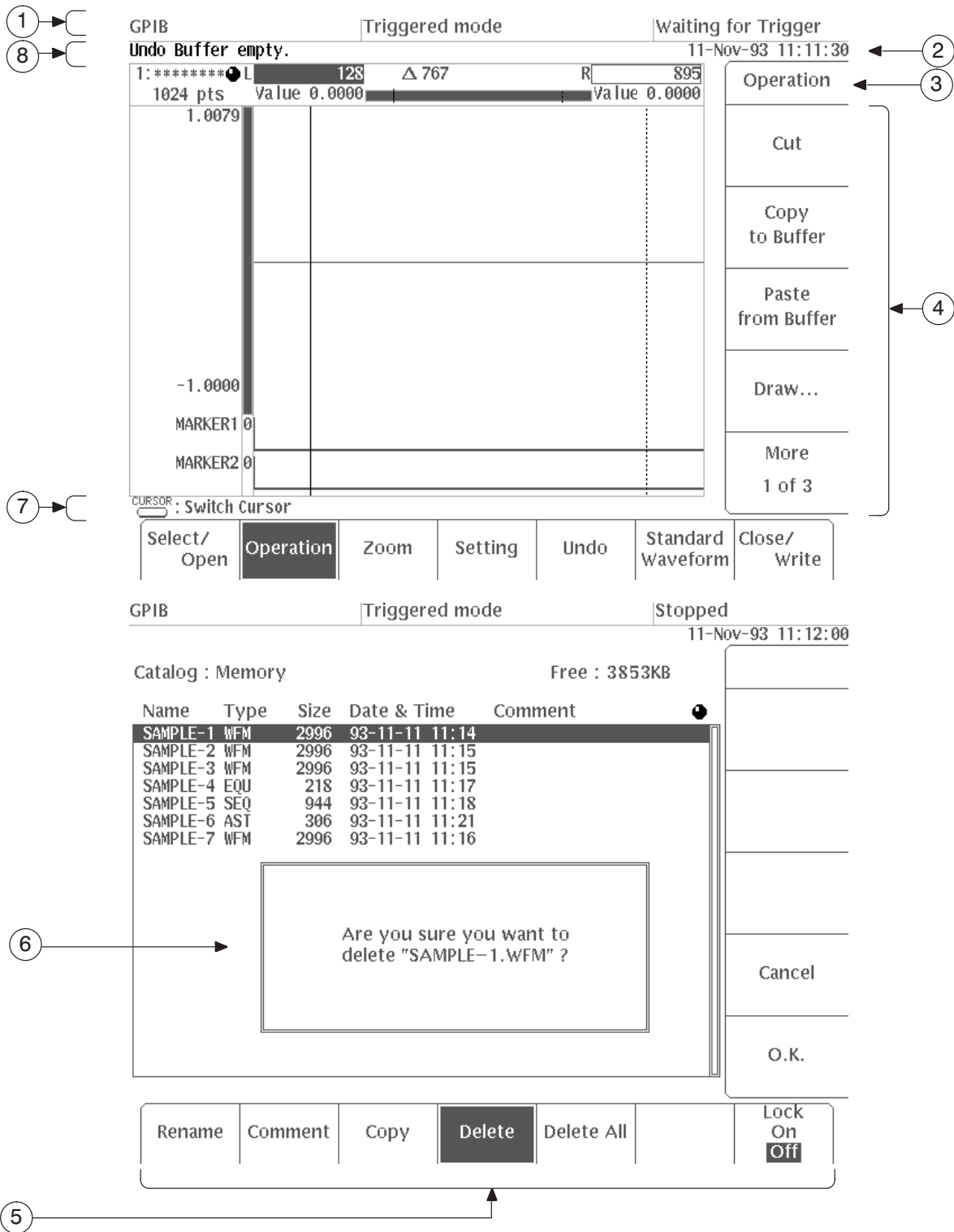

Figure 2-6: CRT Display

(1) Status Area

The status line always displays the status of the instrument, no matter what menu is displayed on the screen. Four items are shown on the status line: the interface status (see the AWG2000 Series Programmer Manual); the operation mode and the trigger status (see page 4C-5); and the clock icon (⌚) (which indicates that the instrument is busy and cannot accept key input).

(2) Date and Time Area

The date and time are displayed here. The display can be turned on and off in the **UTILITY** menu.

(3) Bottom Menu Label Display

The label for the selected bottom menu item is displayed.

(4) Side Menu

When selecting an item from a bottom menu, the corresponding side menu is displayed at the right of the screen. Item selection, numeral input, and execution of functions are performed by pressing the button corresponding to the side menu item.

(5) Bottom Menu

Press any button of the **MENU** column or the **FG** button to display the corresponding bottom menu in the lower part of the screen. To select an item from a bottom menu, press the corresponding button.

(6) Message Display

This area displays inquiries, or warnings for the user, enclosed in a box.

(7) Button Operation Area

Explanations of each front panel button operation for the current menu are shown in this area.

(8) Message Area

In the event of an error, a message (brighter than normal for easy visibility) is displayed in this area. This message does not require a response. Remote commands can be used to enter a user-designated message.

Basic Menu Operation

Menu Operations

Operations (settings, procedures and selection of parameters for waveform output) are performed on this instrument by means of the system's menus.

When one of the **MENU** buttons in the center of the front panel is pressed, the menu corresponding to that button will appear. There are six menu buttons: the five buttons used in arbitrary waveform generation mode (**SETUP**, **MODE**, **EDIT**, **LOAD/SAVE** and **UTILITY**) and below them the button used in function waveform generation mode (**F.G**). See Figure 2-7.

The menu items displayed on the screen are selected by pressing the corresponding bezel buttons at the bottom of the screen (hereafter referred to as bottom buttons) or to the right of the screen (hereafter referred to as side buttons). There are 7 bottom buttons and 5 side buttons. When one of the buttons is pressed to select an item, that item will be displayed inverted on the screen to indicate that it is operational. See Figure 2-7.

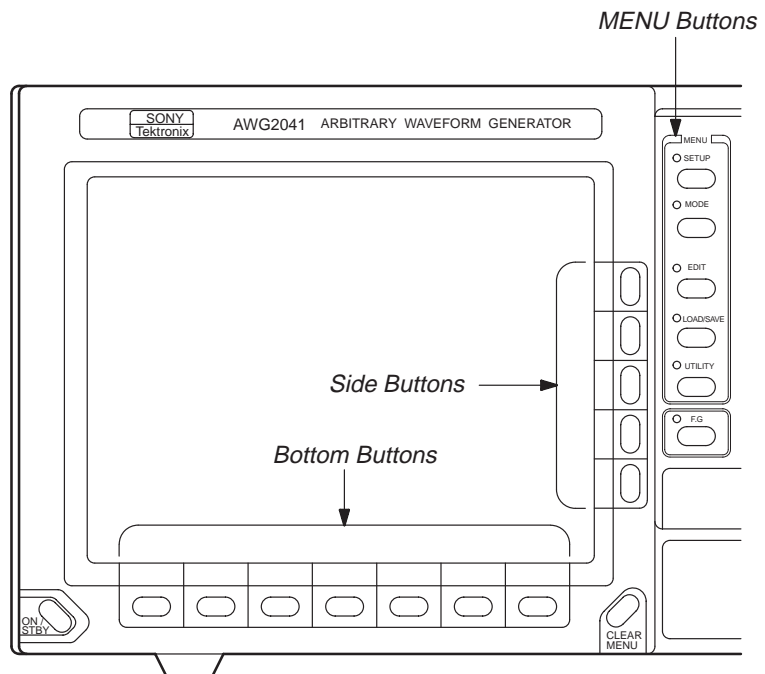

Figure 2-7: Menu Buttons and Bezel Buttons

When you select the desired menu item, the numeric input columns and the selections controlled by that menu are displayed. To change the selections and numeric values, use the numeric keys or general purpose knob.

When you select a menu item, one of the following occurs.

- The lower-level menu is presented.
- The desired item can be selected and may have these characteristics:
 - Each time the bezel button is pressed, the selection changes.
 - A list is presented from which you can select.
- Numeric values can be input.
- The moment the menu item is selected, the function is executed.

Menu Names

The on-screen menus are hierarchical. This section will give the names of the menus in order from top (first level) to bottom.

Main Menu

There are several different main menus. Pressing one of the **MENU** buttons causes the corresponding main menu to appear.

Bottom Menu

This menu is shown at the bottom of the screen. These items can be selected by pressing the corresponding bottom button.

Side Menu

This menu is shown in the right-hand side of the screen. These items can be selected by pressing the corresponding side button.

Sub-Menus

These menus are shown below the side menu. When an item in the side menu is followed by an ellipsis (...), it indicates that that item has a sub-menu listing additional choices.

Numeric Input

Generally, numbers are entered using one of the following methods:

- Enter the desired value using the numeric keys
- Turn the general purpose knob to set the desired value

In the following section, we will explain these numeric input methods in more detail.

Using the Front Panel Numeric Keys

To specify numeric values with the numeric keys, **ENTER** key, and unit keys on the front panel, perform the following steps.

- Step 1:** Press the button for the menu item you want to change.
- Step 2:** Use the numeric keys to input the desired value.
- Step 3:** Press one of the unit keys or the **ENTER** key.

Figure 2-8 shows the menu displayed when **Amplitude** is selected from the **SETUP** menu. In this figure, the numeric keys are used to change the amplitude. Here the asterisk in the numeric input column indicates that the value is being input. Press the front panel **ENTER** key to enter the value and remove the asterisk.

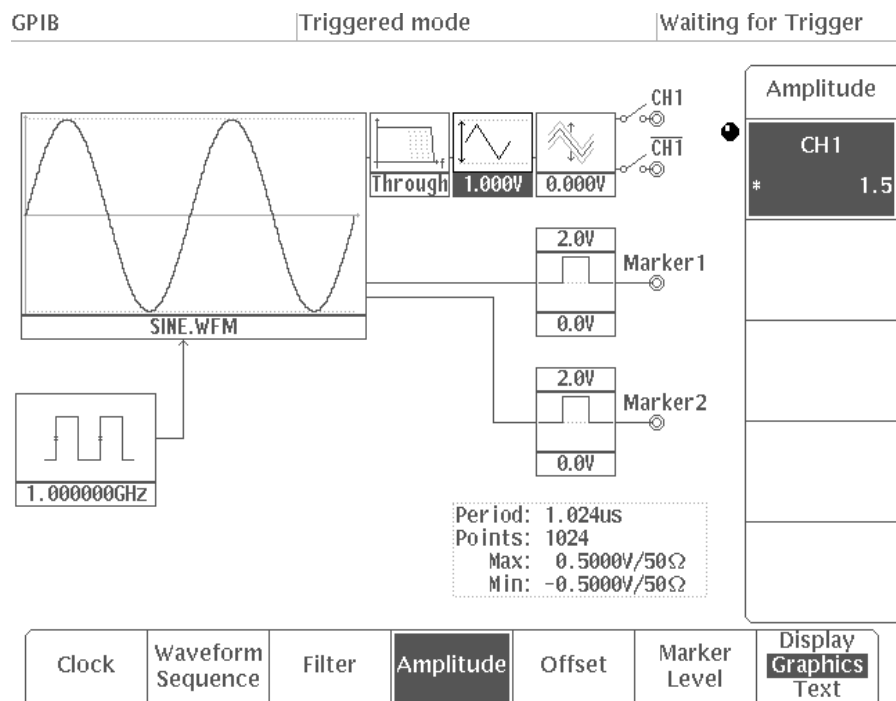

Figure 2-8: Numeric Input Using Numeric Keys

Numeric input keys

Four types of keys are used to enter numeric values: the numeric keys (0 – 9), the unit keys (GHz/ns, MHz/ μ s, kHz/ms/mV and Hz/s/V), the delete key and the **ENTER** key. These are shown in Figure 2-9.

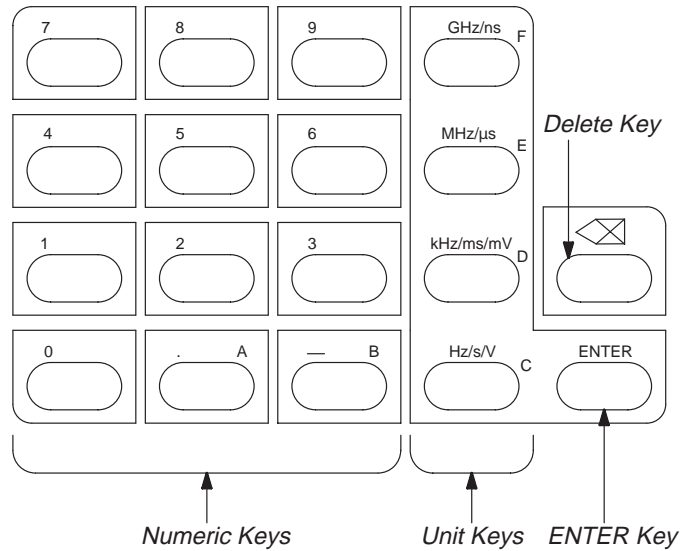

Figure 2-9: Numeric Keys, Unit Keys, Delete Key, and ENTER Key

Numeric Input Examples

Example 1: Clock frequency numeric input
(Clock in **SETUP** menu)

The value before input mode was 100.0000 kHz and is to be changed to 12.3 kHz. Pressing the "1", "2", ".", "3", and **ENTER** keys in order changes the input column this way:

Table 2-1: Numeric Value Input Example 1

Input Key	Numeric Value Column	Numeric Value Status
	100.0000kHz	Before input
1	* 1	During input
2	* 12	
.	* 12.	
3	* 12.3	
ENTER	12.3000kHz	Entered

When you press one of the numeric keys, the instrument switches to numeric input status and the value that has been entered is displayed in the input column, preceded by an asterisk. Enter other numbers as desired and then press the **ENTER** key to confirm the value. Unless otherwise designated, the unit that is used for numeric input will be the same as when numbers were previously entered.

To change the unit to MHz, press "1", "2", ".", "3", and **MHz/μs** keys in order. This changes the value to 12.30000 MHz. The frequency is expressed by a seven-digit number.

When a value has been entered, pressing one of the unit keys will change the unit to that value and will confirm the number that has been entered. If you press the unit key before inputting a numeric value, only the unit will change; the numeric value that is currently displayed will be unaffected.

NOTE. After a value has been entered, if you proceed to another menu item without first pressing either a unit key or **ENTER**, the input operation will be canceled; the value you have entered will be discarded and the previous value will be retained. If you attempt to enter a value outside the allowable range, whether too high or too low, the value will change to the closest allowable value (in other words, either the minimum or the maximum value).

Example 2: Offset numeric input
(Offset in **SETUP** menu)

This example changes the offset from 1.000 V to -0.030 V (30 mV). The input is as shown in this table.

Table 2-2: Numeric Value Input Example 2

Input Key	Numeric Value Column		Numeric Value Status
	1.000V		Before input
–	*	–	
3	*	3	During input
0	*	30	
kHz/ms/mV	–0.030 V		Entered

In this case, pressing "–", ".", "0", "3" **Hz/sec/V** also enters a value of -0.030 V. The unit is displayed as "V".

Using the General Purpose Knob

When the knob icon is displayed on the CRT screen, numeric values can be set using the general purpose knob and the ← (left/down) and → (right/up) buttons. When setting numeric values in this manner, the value in the number column will be increased or decreased for the underscored and upper digits. Values will decrease when the general purpose knob is turned counterclockwise and increase when the general purpose knob is turned clockwise. Values cannot be changed outside the parameter range. Figure 2-10 shows the general purpose knob and arrow buttons. Figure 2-11 shows the knob icon and the underscore in the menu column of numeric input.

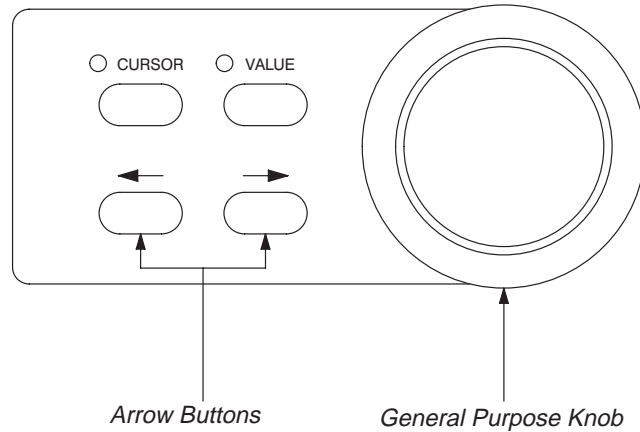

Figure 2-10: General Purpose Knob, and Arrow Buttons

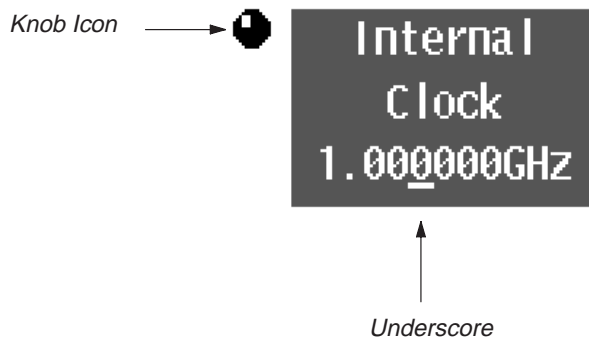

Figure 2-11: Knob Icon and Underscore

When a numeric value has been changed using the general purpose knob, there is no need to confirm it by pressing the **ENTER** key on the front panel. The numeric value is entered automatically without pressing the **ENTER** key. To change a value using the general purpose knob, perform the following steps.

- Step 1:** Press the button for the menu item you want to change.
- Step 2:** Press the ← and → buttons to specify the digit to be the index for input.

The amount of change obtained by turning the general purpose knob is controlled with the front panel ← and → keys. Press the ← key to move the underscore to the left and thus raise the amount of change to 10x. Or press the → key to move the underscore to the right and thus reduce the amount of change for general purpose knob turning to 1/10th.

- Step 3:** Turn the general purpose knob to change the value.

Numeric Specification Example

Turning the general purpose knob one click clockwise increases the value of the underscored digit by 1. Turning it one click counterclockwise decreases the value by 1. For example, if the value is 173.0 and the cursor is under the 7, turning the general purpose knob clockwise or counterclockwise changes the value as shown below. If the underscored value is already 1, turning the general purpose knob counterclockwise does not decrease the value any further.

173.0	173.0
1 <u>8</u> 3.0	1 <u>6</u> 3.0
1 <u>9</u> 3.0	...
2 <u>0</u> 3.0	23.00
2 <u>1</u> 3.0	13.00
Turning clockwise	Turning counterclockwise

When the value has already been increased to the maximum allowable value for the parameter, turning the general purpose knob further clockwise has no effect. Similarly, when the value has already been decreased to the minimum allowable value for the parameter, turning the general purpose knob further counterclockwise has no effect.

Operating Examples

In this section, we will use simple examples to illustrate the basic procedures for waveform output on the AWG2041. Six examples will be given; these are listed below. Buttons and menu items to be used will be shown to the left, and a description of the corresponding operation will appear on the right.

First of all, you should make sure the power to this instrument has been turned on; see Section 1 "Start Up" for instructions on how to do this.

Example 1: Setting the Date & Time and Adjusting the Brightness

Example 2: Output of a Waveform Using the Sample Waveform Library Disk

Example 3: Creating Files and Arbitrary Waveform Outputs

- Creating a Waveform File
- Creating Arbitrary Waveforms Using the Point Draw Function
- Creating Waveforms Arithmetically
- Creating an Equation File
- Creating a Sequence File
- Creating an Autostep File
- Setting the Output Parameters
- Setting Operation Mode and Waveform Output

Example 4: Loading and Saving Files

Example 5: Loading Waveforms From Other Instruments

Example 6: Using the Waveform Function Generator

When a detailed description of a function is needed at the operation stage, see the section dealing with that particular menu (4A – 4F).

NOTE. *These examples do not cover all of the functions and special features of the instrument. The purpose of the examples is only to give you practice in executing basic operations on the instrument.*

Necessary Equipment

The following equipment is needed to execute Examples 1 – 6:

- Digital storage oscilloscope (Tektronix TDS series or equivalent)
- 50Ω cables (2)
- GPIB cable (1)
- 50Ω terminator (1)
- Sample waveform library disk (included with the instrument as a standard accessory)
- Signal generator

Example 1: Setting the Date & Time and Adjusting the Brightness

In Example 1, you will set the date and time on the instrument's built-in clock and adjust the brightness of the screen.

Setting the Date and Time

In this operation, you will set the date and time on the instrument.

Be sure to do this when using the instrument for the first time. Once set, there will usually be no need to reset these values. However, if the instrument has not been used for an extended period of time, the date and time may be incorrect; in such cases, you should set these values again using the same procedure. The date and time are important, as they are used as a time stamp when creating or editing files.

In this example, you will set the date to November 12, 1995 and the time to 15:30, using the following procedure.

Step 1: Press the **UTILITY** button in the **MENU** column.

Step 2: Select **Date Time** from the bottom menu. The menu shown in Figure 2-12 will appear.

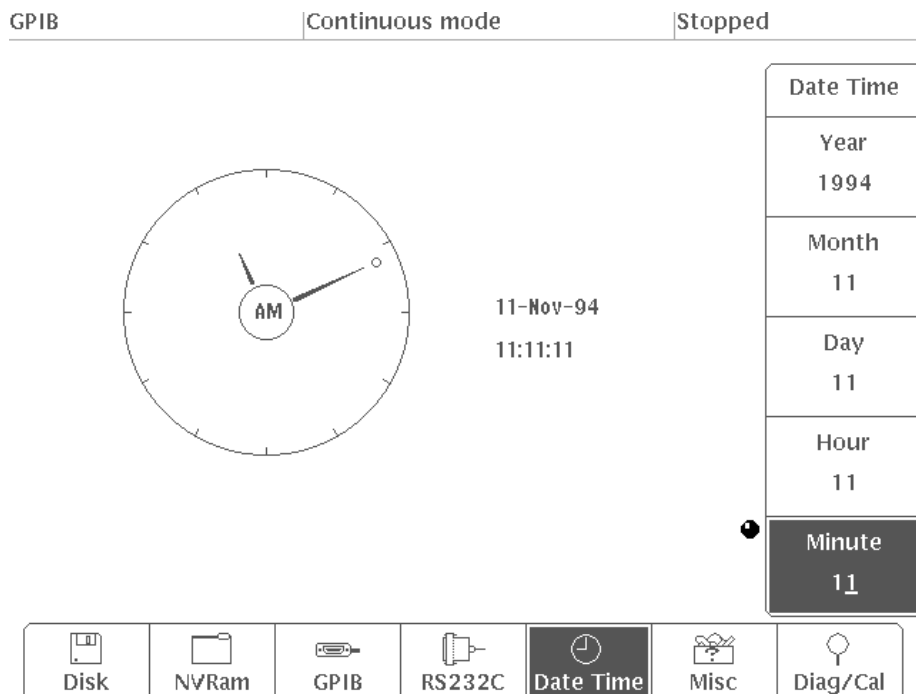
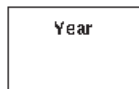
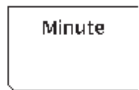

Figure 2-12: Menu Display (showing Date/Time item selected)



1995



30

- Step 3:** Select **Year** from the side menu.
- Step 4:** Turn the general purpose knob to set the year to **1995**.
- Step 5:** In the same manner, select **Month**, **Day**, and **Hour** from the side menu and set the values to November, 12 and 15, respectively. The time is displayed in 24-hour fashion.
- Step 6:** Select **Minute** from the side menu.
- Step 7:** Use the general purpose knob to set the minute value to 30 by the time signal.

NOTE. When the setting for **Hour** or **Minute** is changed, the value for seconds will be reset to 0.

Date/Time Display

It is possible to have the date and time constantly displayed on the screen. To do this, use the following procedure:

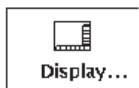

- Step 8:** Select **Misc** from the bottom menu.
- Step 9:** Select **Display...** from the side menu.
- Step 10:** Press **Date Time** in the sub-menu and select **On**. The current date and time will be displayed in the upper right-hand corner of the screen, as shown in Figure 2-13.

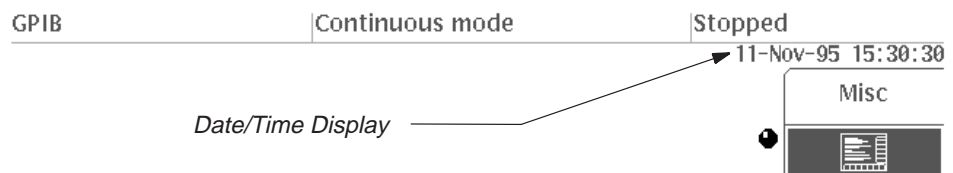

Figure 2-13: Date/Time Display

Setting the Display Brightness

In this operation, you will set the display brightness of the screen. The display offers three different levels of brightness. Use the following procedure to adjust the overall display brightness to the proper level:



Step 11: Select **Brightness** from the side menu.

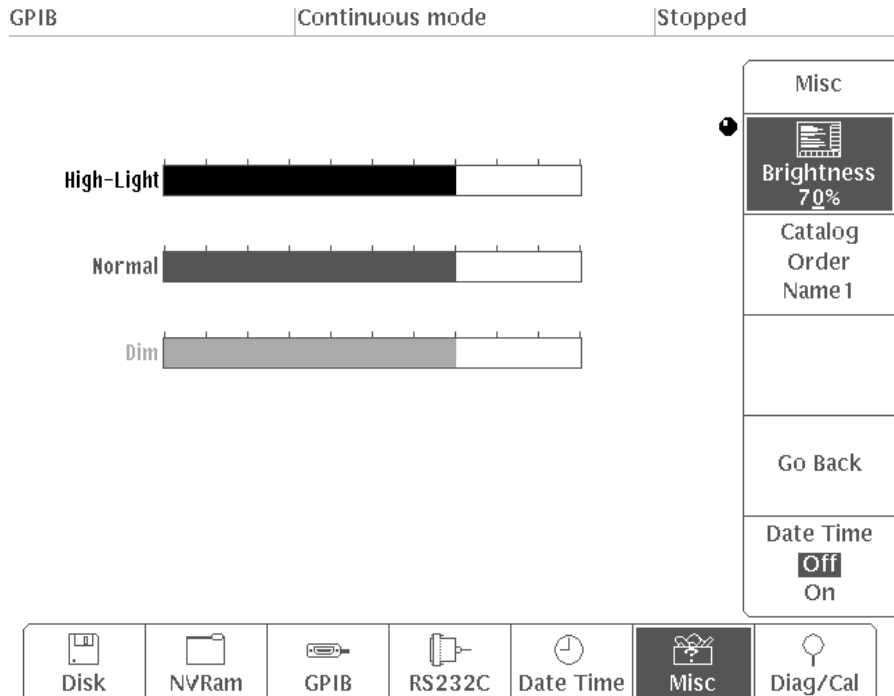

Figure 2-14: Setting the Display Brightness

● 0~100%

Step 12: Turn the general purpose knob to set the brightness to the proper level.

The brightness can be changed between 0% and 100% in 1% increments; the default setting is 70%.

This completes the Example 1.

Example 2: Output of a Waveform Using the Sample Waveform Library Disk

LOAD/SAVE



Device



Disk

Load

In Example 2, you will output a waveform using the sample waveform library disk, a standard accessory included with the instrument.

Loading Sample Waveforms

The sample waveform should be loaded from the floppy disk to the internal memory of the instrument.

- Step 1:** Press the **MENU** column **LOAD/SAVE** button.
- Step 2:** Select **Device** from the bottom menu.
- Step 3:** Select **Disk** from the side menu.
- Step 4:** Select **Load** from the bottom menu.
- Step 5:** Insert the sample waveform library disk that comes with this instrument into the floppy disk drive.

NOTE. Do not remove the floppy disk while the floppy disk drive is operating. This can destroy the data and cause errors.

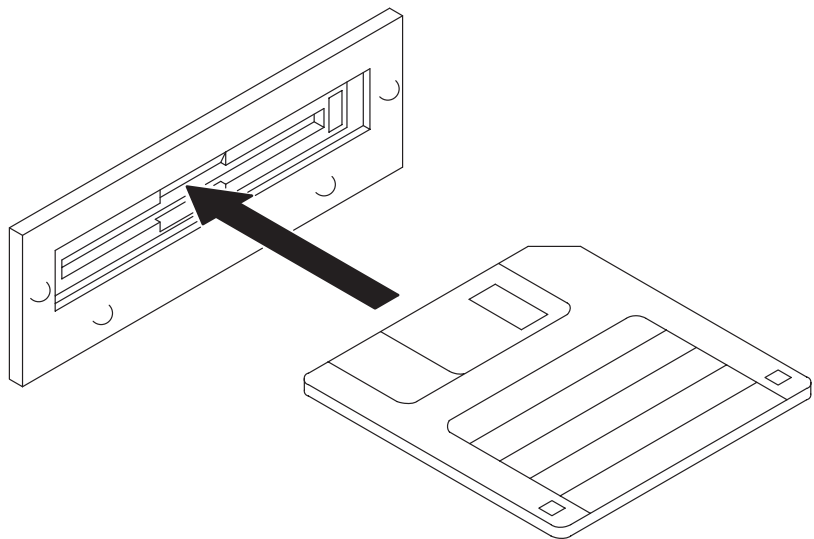

Figure 2-15: Inserting the Floppy Disk

The files will be displayed in the lower box of the **LOAD** menu. Figure 2-16 shows how the files on the sample waveform library disk are displayed on the screen.

GPIB
Continuous mode
Stopped

Catalog : Memory Free : 3867KB

Name	Type	Size	Date & Time	Comment

Load

Load

Load All

Change Directory

Catalog : Disk \ Free : 1020KB

Name	Type	Size	Date & Time	Comment
*AM	EQU	822	93-11-18 09:30	AMPLITUDE MODULATION
*AM	WFM	64102	93-11-18 09:30	
*D_EXP	EQU	744	93-11-18 09:33	DOUBLE EXPONENTIAL PULSE
*D_EXP	WFM	20582	93-11-18 09:33	
*FM	EQU	744	93-11-18 09:28	FREQUENCY MODULATION
*FM	WFM	65638	93-11-18 09:28	
*GAUSS_P	EQU	666	93-11-18 09:33	GAUSSIAN PULSE
*GAUSS_P	WFM	614	93-11-18 09:33	
*LIN_SWP	EQU	744	93-11-18 09:33	LINEAR FREQUENCY SWEEP

Change Directory

Device	Load	Save				Auto Load
Disk						Off

Figure 2-16: Sample Waveform Library Disk Files

Load All

- Step 6:** Select **Load All** from the side menu. The display shown in Figure 2-17 will appear.

GPIB	Continuous mode	Stopped
Catalog : Memory Free : 3460KB		Load
Name	Type	Size
Date & Time	Comment	
#AM	EQU	842
93-11-18 09:30	AMPLITUDE MODULATION	
#AM	WFM	64948
93-11-18 09:30		
#D_EXP	EQU	764
93-11-18 09:33	DOUBLE EXPONENTIAL PULSE	
#D_EXP	WFM	21428
93-11-18 09:33		
#FM	EQU	764
93-11-18 09:28	FREQUENCY MODULATION	
#FM	WFM	66484
93-11-18 09:28		
#GAUSS_P	EQU	686
93-11-18 09:33	GAUSSIAN PULSE	
#GAUSS_P	WFM	1460
93-11-18 09:33		
#LIN_SWP	EQU	764
93-11-18 09:33	LINEAR FREQUENCY SWEEP	
Catalog : Disk \ Free : 870KB		Load All
Name	Type	Size
Date & Time	Comment	
#AM	EQU	822
93-11-18 09:30	AMPLITUDE MODULATION	
#AM	WFM	64102
93-11-18 09:30		
#D_EXP	EQU	744
93-11-18 09:33	DOUBLE EXPONENTIAL PULSE	
#D_EXP	WFM	20582
93-11-18 09:33		
#FM	EQU	744
93-11-18 09:28	FREQUENCY MODULATION	
#FM	WFM	65638
93-11-18 09:28		
#GAUSS_P	EQU	666
93-11-18 09:33	GAUSSIAN PULSE	
#GAUSS_P	WFM	614
93-11-18 09:33		
#LIN_SWP	EQU	744
93-11-18 09:33	LINEAR FREQUENCY SWEEP	
		Change Directory
Device	Load	Save
Disk		
		Auto Load
		Off

Figure 2-17: CRT Screen Display When Load All is Selected

All the files in the lower box on the screen are loaded into internal memory. The loaded files are displayed in the internal memory list in the upper box on the screen.

Turn the general purpose knob to scroll through the list of files displayed in the lower box on the screen. For explanations of the waveform in each file, see Sample Waveform Library in Appendix C.

NOTE. The sample waveform library disk files are locked (and * is displayed next to their names). You must unlock these files before you can edit them.

Setting the Output Parameters

These parameters are used for waveform output.



- Step 7:** Press the **MENU** column **SETUP** button. The **SETUP** menu is displayed.

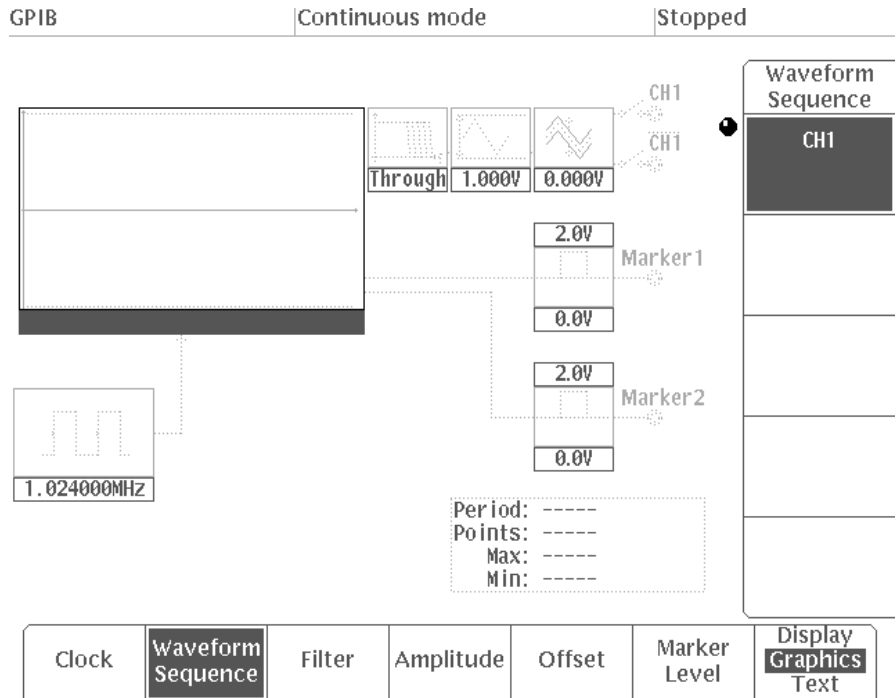
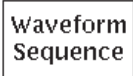

Figure 2-18: SETUP Menu



- Step 8:** Select **Waveform Sequence** from the bottom menu.

GAUSS_P.WFM

- Step 9: Turn the general purpose knob to develop the waveform file list. Select the file **GAUSS_P.WFM** from this list.

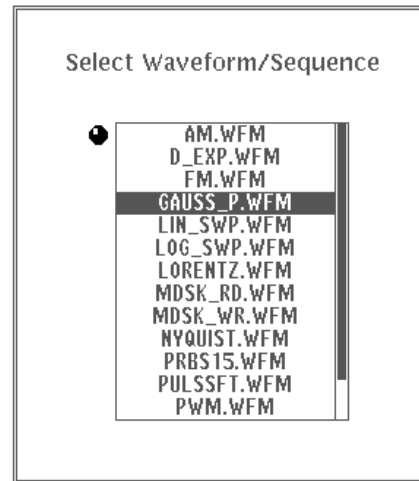

Figure 2-19: Waveform File List

O.K.

- Step 10: Select **O.K.** from the sub-menu. The selected file will be confirmed and the output conditions will be automatically set. Figure 2-20 shows the **SETUP** menu with the file **GAUSS_P.WFM** selected.

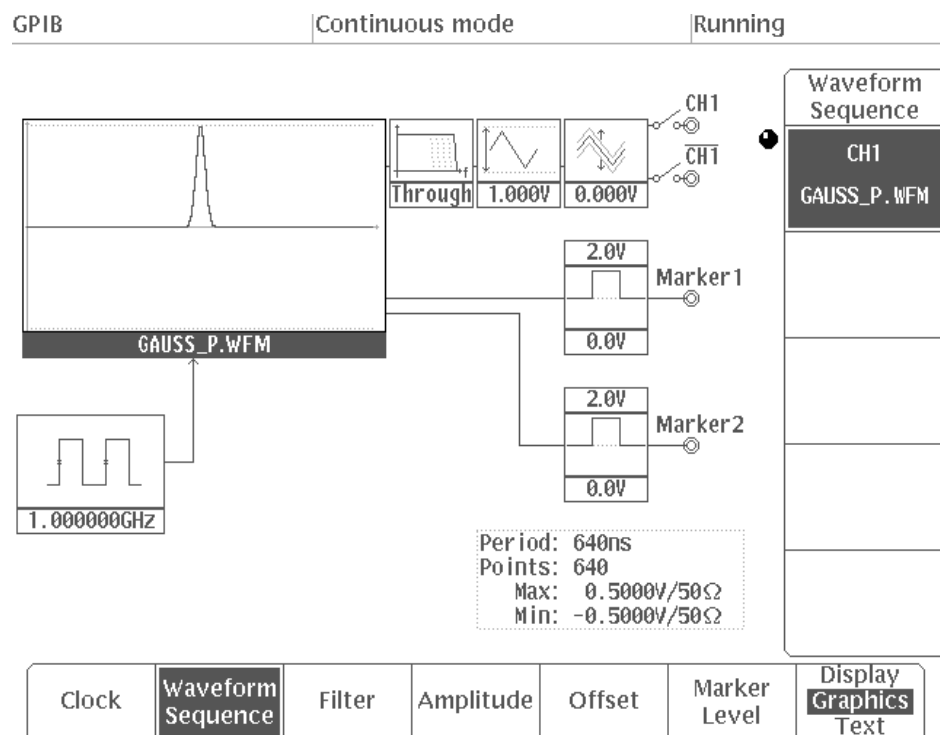

Figure 2-20: GAUSS_P.WFM File Output Parameters

NOTE. The selected file is locked. Therefore, although changes can be made to the waveform clock, filter, amplitude, offset and other output conditions, these changes cannot be saved to the file.



Step 11: Press the **MENU** column **MODE** button. The **MODE** menu is displayed.

The files selected from the **SETUP** menu are displayed in the **MODE** menu.

GPIB | Continuous mode | Running

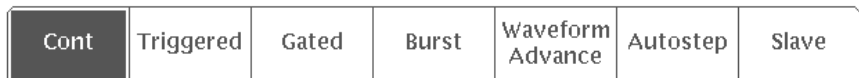
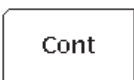

Figure 2-21: MODE Menu



Step 12: Select **Cont** from the bottom menu. When **Cont** is selected, the waveform is continuously output.

Waveform Output

Step 13: Connect this instrument and the oscilloscope with a 50Ω cable and a 50Ω termination as shown in Figure 2-22. This instrument's waveform output is calibrated to a 50Ω load.

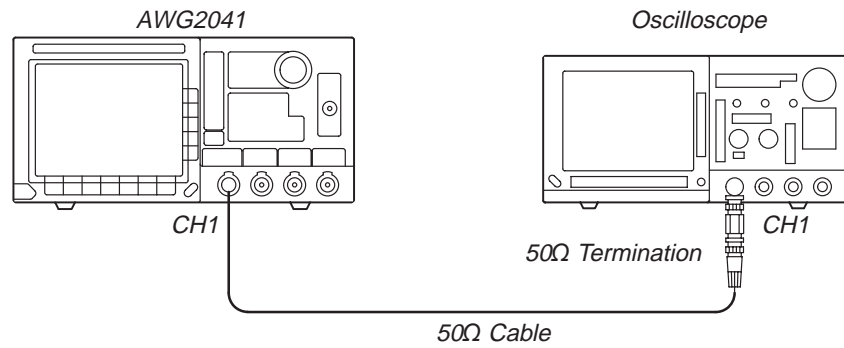

Figure 2-22: Connections in Example 2



- Step 14:** Press the **CH1** On/Off button on the front panel to switch on waveform output. Figure 2-23 shows the channel On/Off button and indicator.

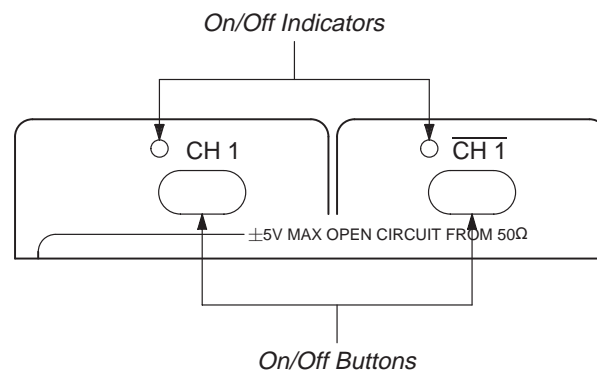

Figure 2-23: Channel On/Off Buttons and Indicators

When the Channel is on, the indicator lights up and the set waveform is output from the **CH1** output connector.

- Step 15:** Set the parameters for the connected oscilloscope as shown below and display the waveform on the oscilloscope screen.

Volt/Div.	200mV/Div.
Time/Div.	200ns/Div.
Trigger Mode	Auto

When you change the **Clock**, **Amplitude**, or **Offset** items with the **SETUP** menu, the waveform changes in real time.

This completes the Example 2.

Example 3: Creating Files and Arbitrary Waveform Outputs

When using the instrument for arbitrary waveform output, you should first use the editors in the **EDIT** menu to create the waveform to be output. In this operation, you will create an arbitrary waveform with the editors, and then you will set the conditions for waveform output (frequency, amplitude, offset, etc.) in the **SETUP** menu. Finally, you will set the operation mode in the **MODE** menu to output the waveform.

In Example 3, we will practice the following series of operations:

- Creating a Waveform File
- Creating Arbitrary Waveforms Using the Point Draw Function
- Creating Waveforms Arithmetically
- Creating an Equation File
- Creating a Sequence File
- Creating an Autostep File
- Setting the Output Parameters
- Setting Operation Mode and Waveform Output

Creating a Waveform File

Use the waveform editor graphic display to create a waveform file by performing the following steps:

- Step 1:** Press the **EDIT** button in the **MENU** column. Figure 2-24 shows the initial menu displayed.

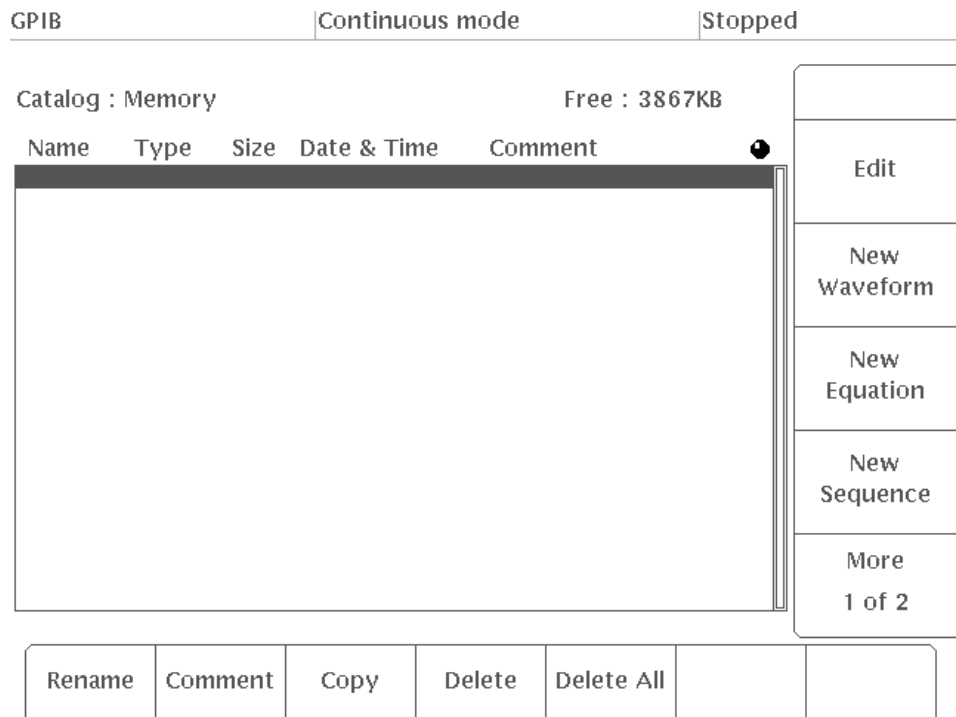

Figure 2-24: Initial Menu

New
Waveform

Step 2: Select **New Waveform** from the side menu.

Figure 2-25 shows the waveform editor graphic menu. The default for the number of points in the waveform is 1024.

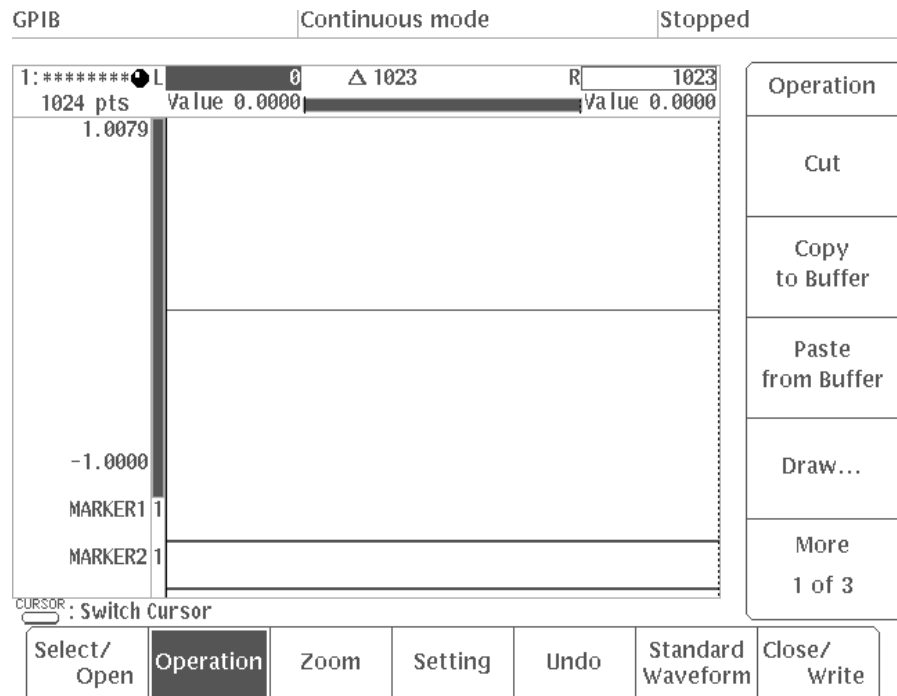

Figure 2-25: Waveform Editor Graphic Menu

CURSOR

Step 3: Press the **CURSOR** button on the front panel to activate the right side vertical bar cursor (it becomes a solid line).

Pressing the **CURSOR** button toggles the selected vertical bar cursor from right to left and back again. You can move the selected cursor using the general purpose knob or the numeric keys.

Operating Examples

5 1 1 ENTER

- Step 4:** Press the following key sequence: **5, 1, 1, ENTER**. This sets the point value for the right side vertical bar cursor to 511 (see Figure 2-26).

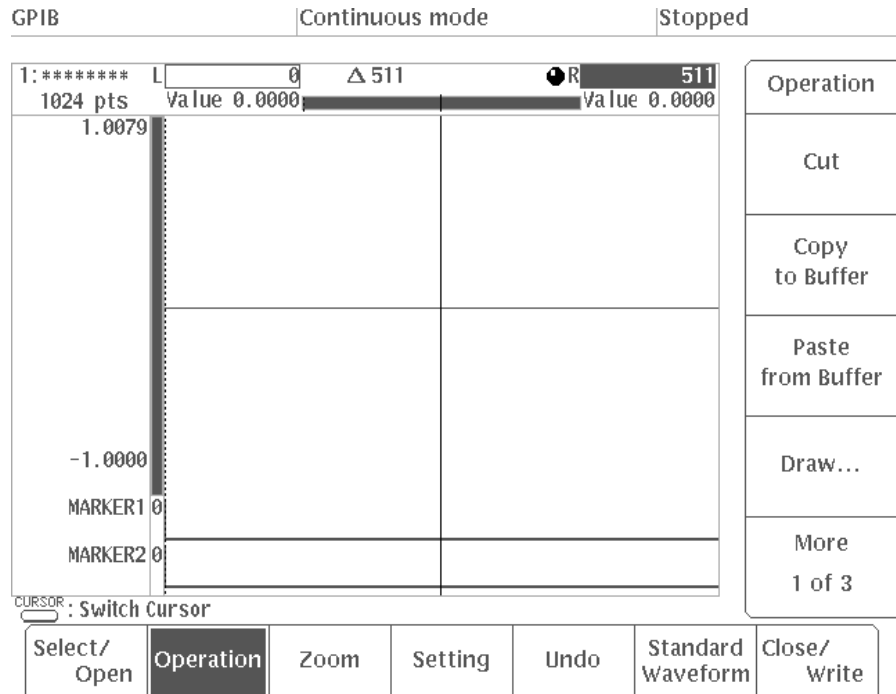

Figure 2-26: Setting the Point Value for the Right Side Vertical Bar Cursor

Standard
Waveform

Type

● Sine

Cycle

2 ENTER

- Step 5:** Select **Standard Waveform** from the bottom menu.
- Step 6:** Select **Type** from the side menu.
- Step 7:** Turn the general purpose knob to select **Sine**.
- Step 8:** Select **Cycle** from the side menu.
- Step 9:** Press "2" and **ENTER** in that order to set the number of cycles for the sine wave to 2.

Execute

Step 10: Select **Execute** from the side menu.

A two-cycle sine waveform is created between the vertical bar cursors (see Figure 2-27).

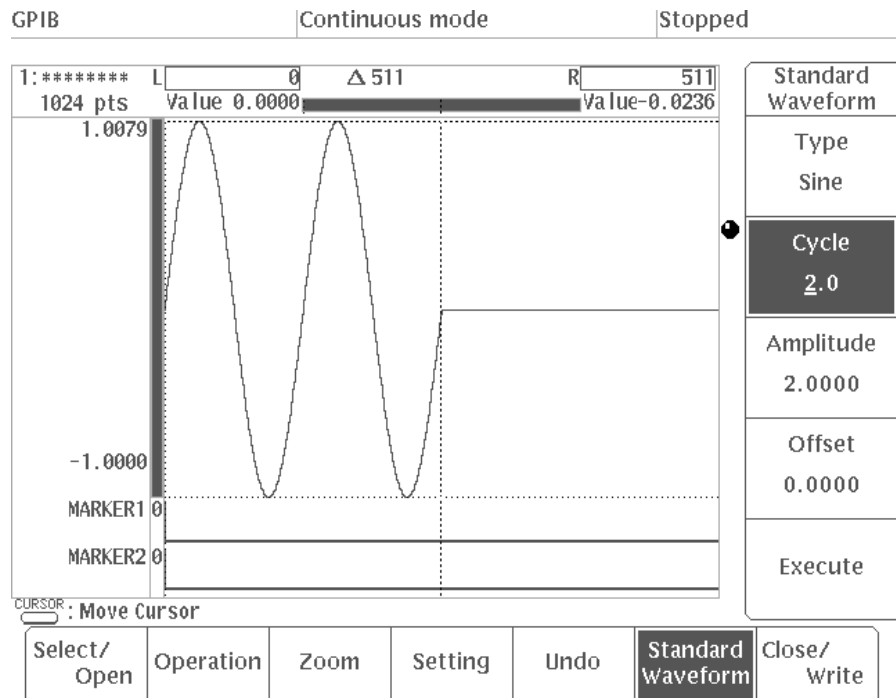
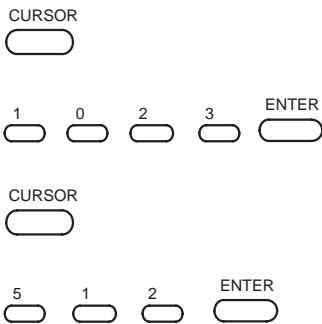

Figure 2-27: Creating a Sine Waveform



Step 11: Press the **CURSOR** button to activate the right side vertical bar cursor.

Step 12: Press the following key sequence: **1, 0, 2, 3, ENTER**. This sets the point value of right cursor to 1023.

Step 13: Press the **CURSOR** button to activate the left side vertical bar cursor.

Step 14: Press the following key sequence: **5, 1, 2, ENTER**. This sets the point value of left cursor to 512.

Operating Examples

Type

● Ramp

Amplitude

1 ENTER

Offset

. 5 ENTER

Execute

Step 15: Select **Type** from the side menu.

Step 16: Turn the general purpose knob to select **Ramp**.

Step 17: Select **Amplitude** from the side menu.

Step 18: Press "1" and **ENTER** in that order to set the ramp wave amplitude to 1.

Step 19: Select **Offset** from the side menu.

Step 20: Press ".", "5", and **ENTER** in that order to set the ramp wave offset to 0.5.

Step 21: Select **Execute** from the side menu.

A two-cycle ramp waveform is created between the vertical bar cursors (see Figure 2-28).

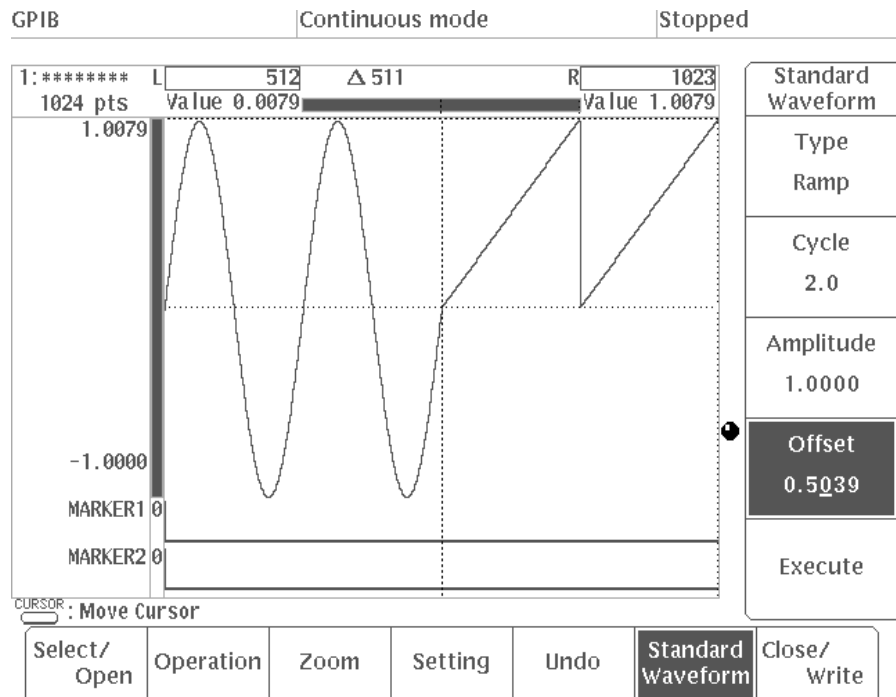

Figure 2-28: Creating a Ramp Waveform

This completes the waveform creation. Next, name the waveform file and exit the waveform editor.

Close/
Write

Write and
Close

● S

VALUE

Step 22: Select **Close/Write** from the bottom menu.

Step 23: Select **Write and Close** from the side menu.

The display used to enter the file name will appear.

Step 24: Input **SAMPLE-1** as the file name.

Use the general purpose knob to select **S** from the character menu.

Then press the **VALUE** button. **S** is inserted into the file name input column. In the same manner, input **A, M, P, L, E, -, 1** (see Figure 2-29).

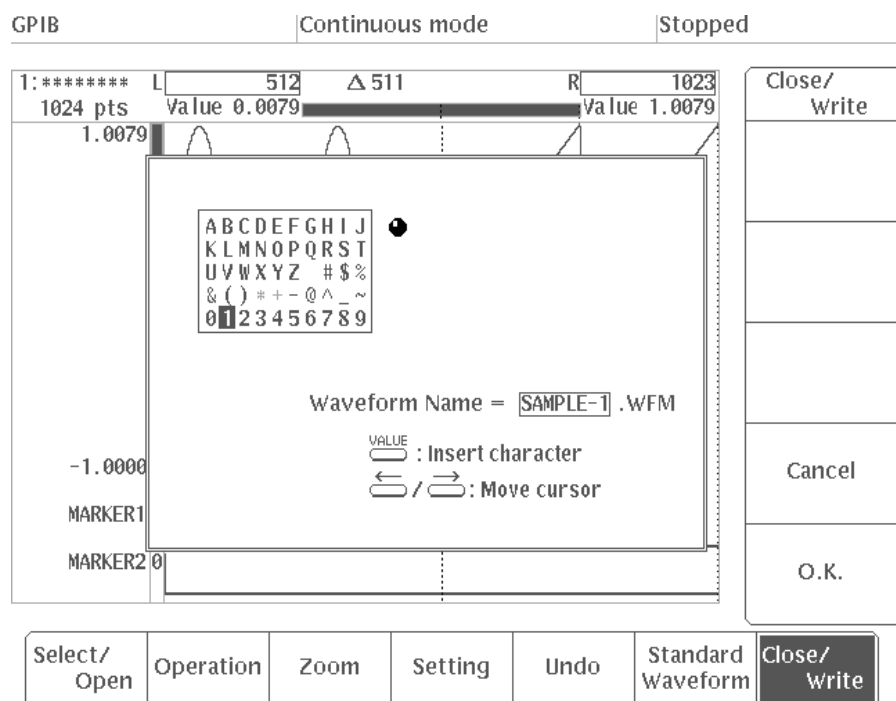

Figure 2-29: Naming a File

O.K.

Step 25: When you finish inputting the file name, select **O.K.** from the sub menu. The system returns to the initial menu and displays the waveform file created (see Figure 2-30). The extension **"WFM"** will be displayed after the file name; this indicates that the file is a waveform file.

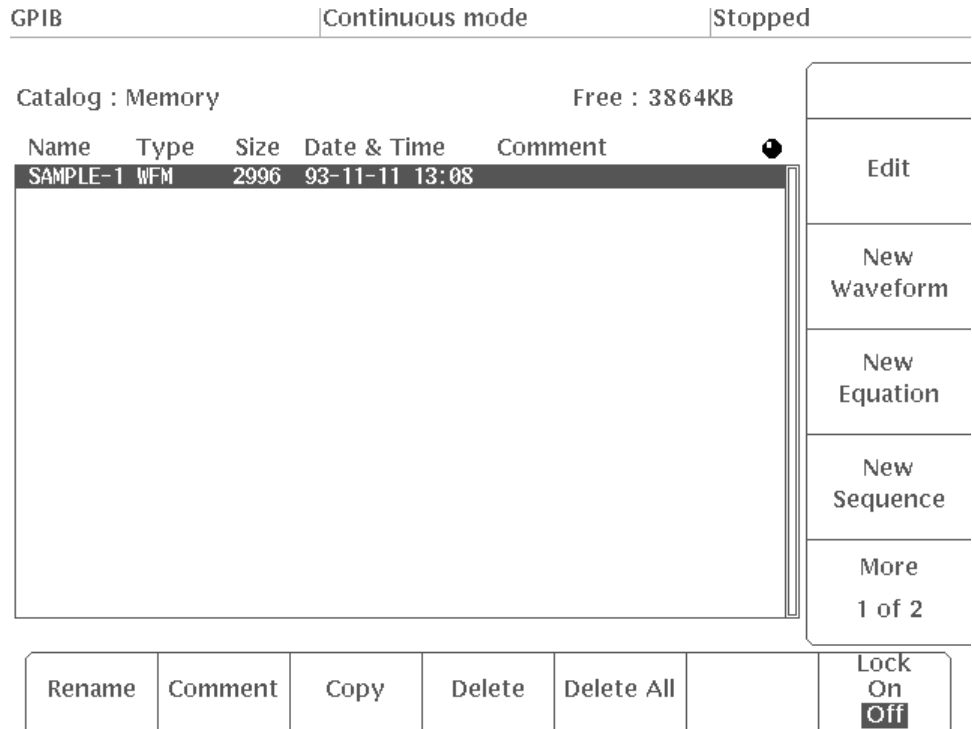

Figure 2-30: Initial Menu File List

Creating Arbitrary Waveforms Using the Point Draw Function

Arbitrary waveforms can be created on the graphic display with the POINT DRAW function.

Use the following procedure to make a copy of the file **SAMPLE-1.WFM** created in the previous operation.

Copy

- Step 1:** In the initial **EDIT** menu, select **Copy** bottom menu. The display used to enter the name of the copy of the file will appear, as shown in Figure 2-31.

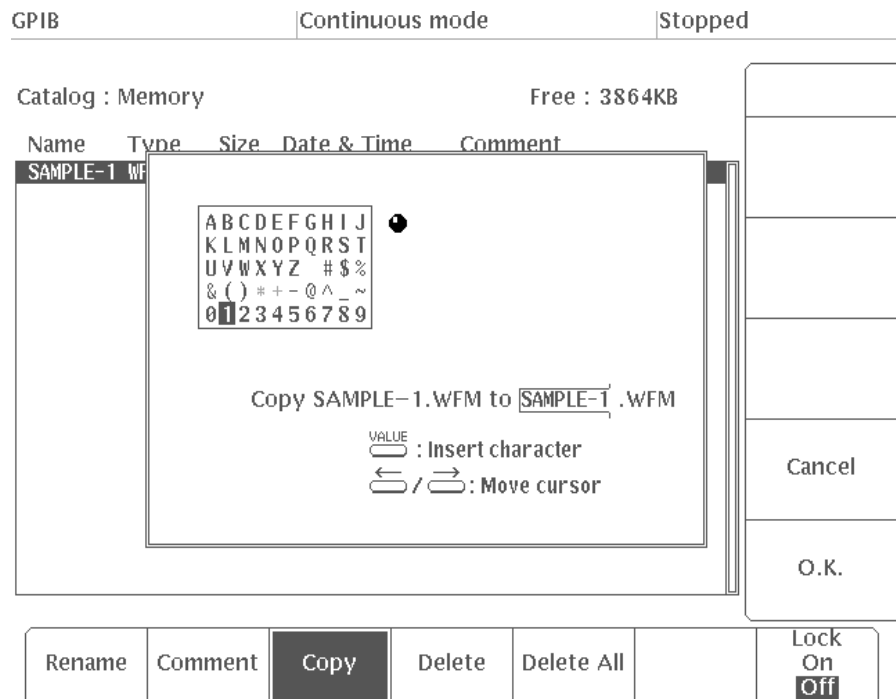

Figure 2-31: Entering a Name for the Copied File

In this example, you will name the copy **SAMPLE-2**.

✉

- Step 2:** Press the **Delete** key on the front panel to delete the "1" in the file name.

2

- Step 3:** Press "2."

O.K.

- Step 4:** Select **O.K.** from the side menu.

SAMPLE-1 will be copied as a new waveform file named **SAMPLE-2**.

Edit

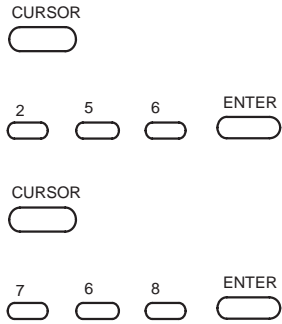

Step 5: Check to make sure that the **SAMPLE-2** waveform file is displayed inverted in the file list in the initial menu. If it is not selected, turn the general purpose knob until the name **SAMPLE-2** is displayed inverted.

Step 6: Select **Edit** from the side menu.

The **SAMPLE-2** waveform file will appear on the screen.

You will now set the range for waveform creation. The arbitrary waveform will be created within this range using the POINT DRAW function.

Step 7: Press the **CURSOR** button on the front panel. This will activate the vertical cursor bar in the left-hand side of the screen.

Step 8: Press "2", "5", "6", and **ENTER** to set the point value of the left cursor to 256.

Step 9: Press the **CURSOR** button on the front panel again to activate the vertical cursor bar in the right-hand side of the screen.

Step 10: Press "7", "6", "8", and **ENTER** to set the point value of the right cursor to 768.

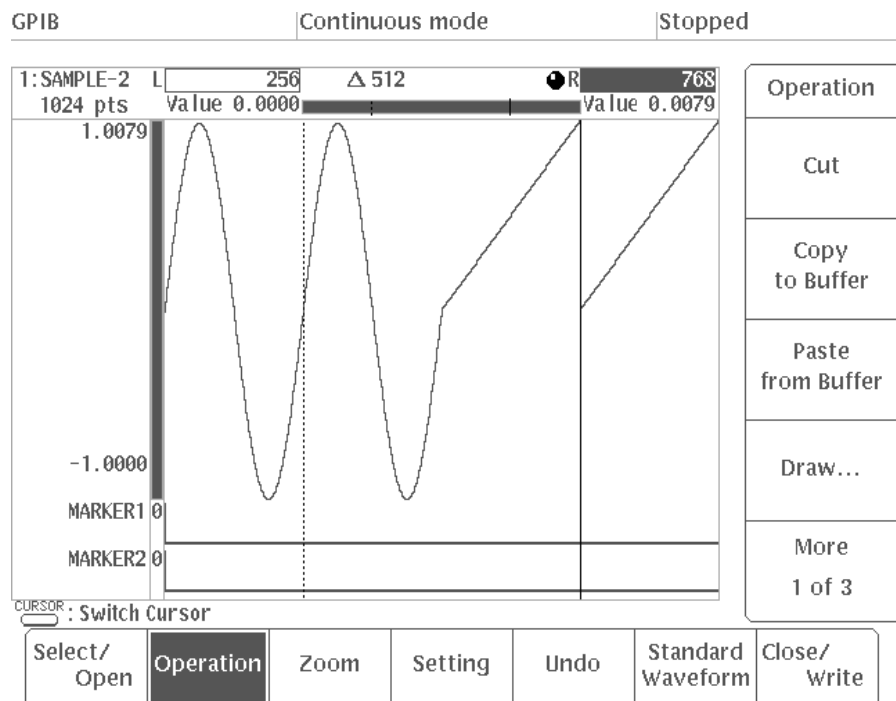
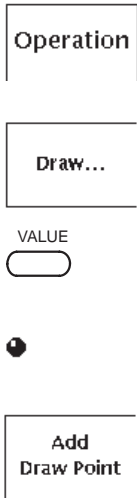

Figure 2-32: Setting the Edit Range

You may now create the arbitrary waveform within the range designated by these two vertical bar cursors, using the POINT DRAW function.



Step 11: Select **Operation** from the bottom menu.

Step 12: Select **DRAW...** from the side menu.

The first point will be drawn.

Step 13: Press the **VALUE** button on the front panel to determine the direction in which the point cursor will move.

Step 14: Using the general purpose knob, move the point cursor to draw another point.

Step 15: Select **Add Draw Point** from the sub-menu.

The point will be confirmed and an **x** will appear at that position.

Step 16: Repeat steps 13 through 15 to determine other points. An example is shown in Figure 2-33.

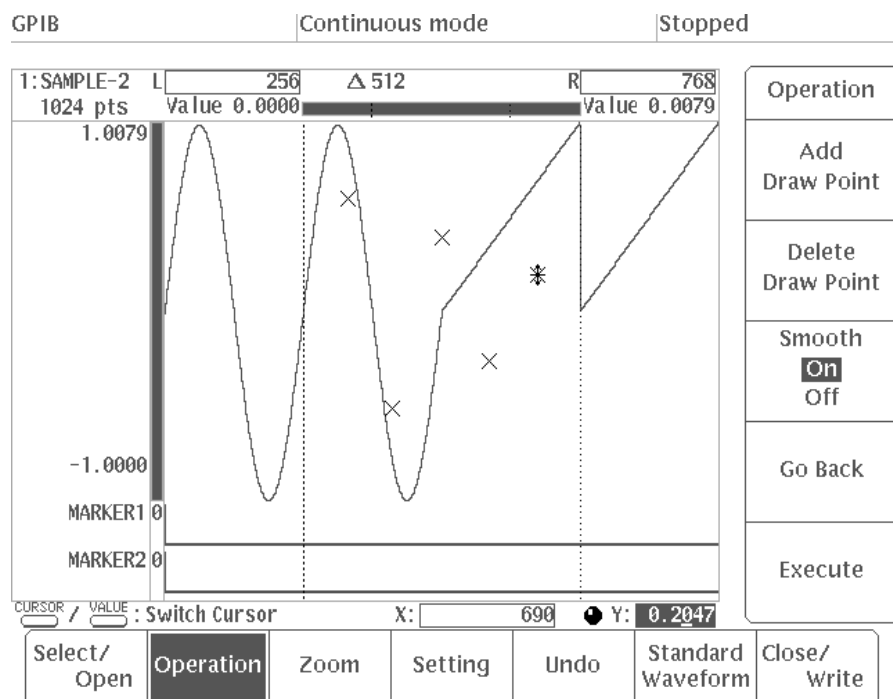
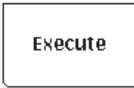
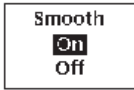

Figure 2-33: Drawing a Waveform Using the Point Draw Function

Operating Examples



- Step 17:** Select **Smooth** from the sub-menu to turn smoothing ON.

Turning smoothing on selects spline interpolation, in which the points that have been drawn and the curve outside the area defined by the left and right vertical bar cursors will be connected in a smooth curve.

Turning smoothing off selects linear interpolation, in which the points that have been drawn and the curve outside the area defined by the left and right vertical bar cursors will be connected using straight lines.

- Step 18:** Select **Execute** from the sub-menu.

The points between the vertical cursors will be connected in a smooth curve (using spline interpolation), as shown in Figure 2-34.

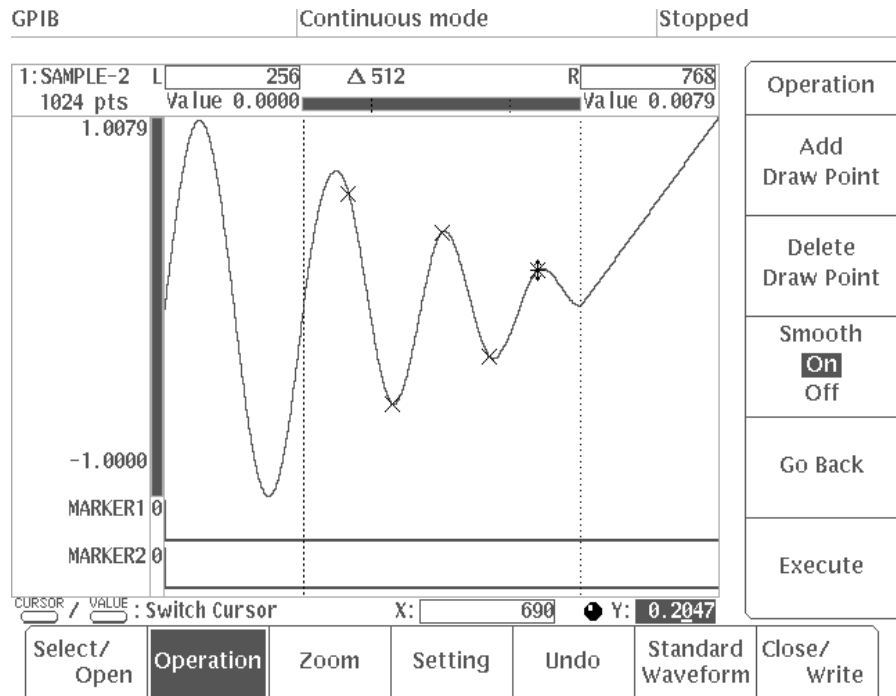
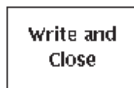
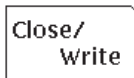

Figure 2-34: Connecting the Points



- Step 19:** Select **Close/Write** from the bottom menu.

- Step 20:** Select **Write and Close** from the side menu.

The data for the **SAMPLE-2** waveform file will be updated and the initial **EDIT** menu will reappear.

Creating Waveforms Arithmetically

You will now add a noise waveform to the sine waveform.

New
Waveform

Standard
Waveform

Amplitude

1 ENTER

Execute

Step 1: Select **New Waveform** from the side menu in the initial **EDIT** menu.

Step 2: Select **Standard Waveform** from the bottom menu.

Step 3: Select **Amplitude** from the side menu.

Step 4: Press "1" and **ENTER** in that order.

Step 5: Check to make sure that the parameters for other items in the side menu are set to the values shown below. If they are different, change them to the values shown below.

Type	Sine
Cycle	1.0
Offset	0.0000

Step 6: Select **Execute** from the side menu.

The sine wave shown in Figure 2-35 will be created.

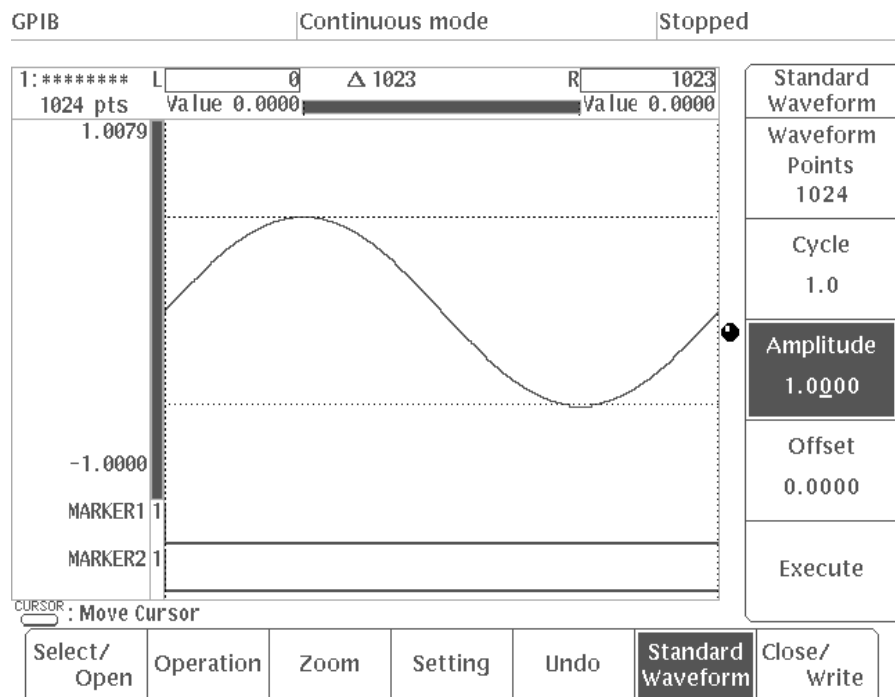

Figure 2-35: Creating a Sine Wave

Operating Examples

Type

● Add Noise

Amplitude

. 3 ENTER

Execute

Step 7: Select **Type** from the side menu.

Step 8: Using the general purpose knob, select **Add Noise**.

Step 9: Select **Amplitude** from the side menu.

Step 10: Press ".", "3", and **ENTER** in that order.

Step 11: Select **Execute** from the side menu.

Noise will be added to the sine wave, as shown in Figure 2-36.

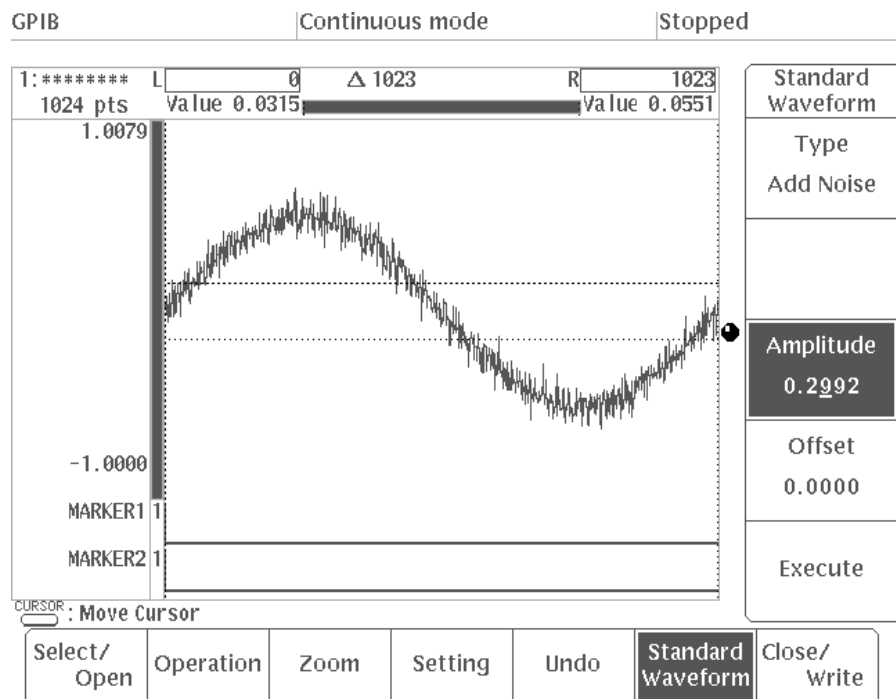

Figure 2-36: Sine Wave With Noise Added

Close/
Write

Write and
Close

Step 12: Select **Close/Write** from the bottom menu.

Step 13: Select **Write and Close** from the side menu.

Step 14: Make the file name **SAMPLE-3**. For details on how to input the file name, see Step 24 in Example 3 in "Creating a waveform file."

Creating an Equation File

This procedure is used to create a waveform using equations.

New Equation

- Step 1:** Select **New Equation** from the side menu.

Figure 2-37 shows the equation editor menu.

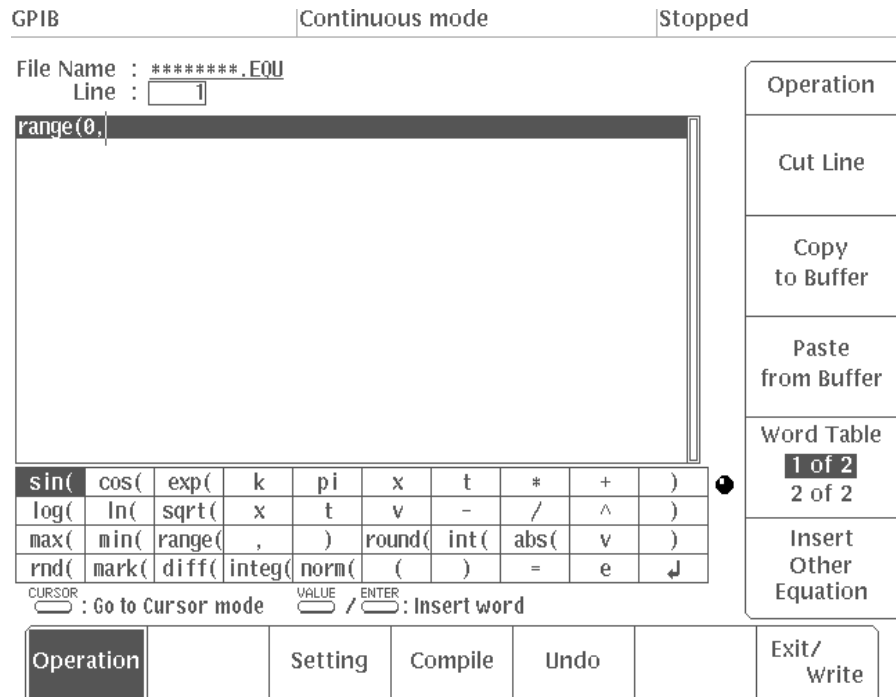

Figure 2-37: Equation Editor Menu Display

To initially define an equation, you must specify its region in time. Do this by selecting "range(" in the component menu. When a new equation file is created, "range(0," will automatically appear in the first line of the equation. Following this notation, you must input the equation end time, as shown in subsequent steps.

Select **Setting** from the bottom menu. When this is done, the default setting (1024) for the number of points will appear. If the clock frequency has been set to 1.024 MHz in the **SETUP** menu, the value will be 0.9765625μs for each point. Accordingly, for 1024 points the waveform period will be 1 ms.

Operation

- Step 2:** Select **Operation** from the bottom menu.

- Step 3:** Set the time from 0 to 500μs. Press the **5, 0, 0, μs, ")**, and **"↵"** (carriage return), in order, using the numeric keys and unit key or by selecting and entering these characters from the items in the component menu.

You can use the general purpose knob to select an item from within the component menu. After selecting an item, press the **VALUE** button or **ENTER** button on the front panel to enter the selected item into the equation list. In addition to selecting the carriage return mark, you can also insert a carriage return by pressing the → key on the front panel.

Now you will create the equation for the time region set in the previous step.

- Step 4:** For the equation, enter $0.5*\sin(4*\pi*x)$. Input **0**, **.**, **5**, *****, **sin**(, **4**, *****, **pi**, *****, **x**, **)** with the numeric keys or from the component menu.
- Step 5:** In the same manner, input the data as shown in Figure 2-38.

```
range(0,500us)
0.5*sin(4*pi*x)
range(500us,1ms)
sin(10*pi*x)
```

Figure 2-38: Equation List Input

Compile

- Step 6:** Select **Compile** from the bottom menu.

After the compiling is complete, the waveform data is created from the equation and the resultant waveform is displayed on the screen. Figure 2-39 shows the compiled waveform data.

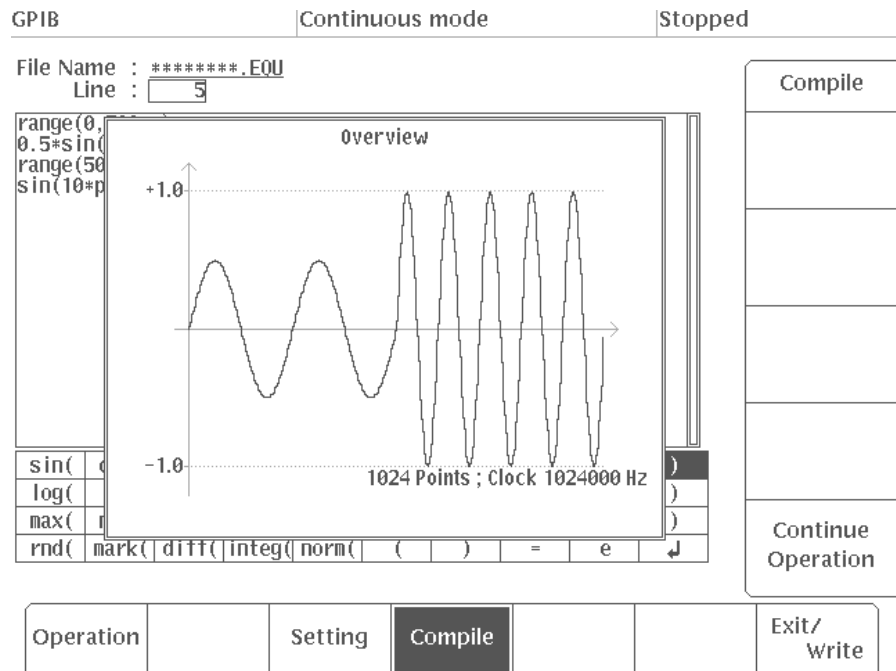

Figure 2-39: Display of Compiled Waveform Data

Continue
Operation

- Step 7:** Select **Continue Operation** from the side menu to return the system to the previous equation edit menu.

Exit/
Write

- Step 8:** Select **Exit/Write** from the bottom menu.

Write and
Exit

- Step 9:** Select **Write and Exit** from the side menu.

- Step 10:** Make **SAMPLE-4** the file name. For details on how to input the file name, see Step 24 in Example 3 in "Creating a waveform file."

O.K.

- Step 11:** When you are finished inputting the file name, select **O.K.** from the sub-menu.

The equation file (**SAMPLE-4.EQU**) and the waveform file (**SAMPLE-4.WFM**) of compiled data with the same name are created and the system returns to the initial menu. See Figure 2-40.

GPIB	Continuous mode	Stopped																													
Catalog : Memory		Free : 3854KB																													
<table border="1" style="width: 100%; border-collapse: collapse;"> <thead> <tr> <th style="text-align: left;">Name</th> <th style="text-align: left;">Type</th> <th style="text-align: left;">Size</th> <th style="text-align: left;">Date & Time</th> <th style="text-align: left;">Comment</th> </tr> </thead> <tbody> <tr> <td>SAMPLE-1</td> <td>WFM</td> <td>2996</td> <td>93-11-11 13:08</td> <td></td> </tr> <tr> <td>SAMPLE-2</td> <td>WFM</td> <td>2996</td> <td>93-11-11 13:10</td> <td></td> </tr> <tr> <td>SAMPLE-3</td> <td>WFM</td> <td>2996</td> <td>93-11-11 13:12</td> <td></td> </tr> <tr style="background-color: #e0e0e0;"> <td>SAMPLE-4</td> <td>EQU</td> <td>452</td> <td>93-11-11 13:14</td> <td></td> </tr> <tr> <td>SAMPLE-4</td> <td>WFM</td> <td>2996</td> <td>93-11-11 13:14</td> <td></td> </tr> </tbody> </table>	Name	Type	Size	Date & Time	Comment	SAMPLE-1	WFM	2996	93-11-11 13:08		SAMPLE-2	WFM	2996	93-11-11 13:10		SAMPLE-3	WFM	2996	93-11-11 13:12		SAMPLE-4	EQU	452	93-11-11 13:14		SAMPLE-4	WFM	2996	93-11-11 13:14		<div style="border: 1px solid black; padding: 5px; margin-bottom: 5px;">Edit</div> <div style="border: 1px solid black; padding: 5px; margin-bottom: 5px;">New Waveform</div> <div style="border: 1px solid black; padding: 5px; margin-bottom: 5px;">New Equation</div> <div style="border: 1px solid black; padding: 5px; margin-bottom: 5px;">New Sequence</div> <div style="border: 1px solid black; padding: 5px; margin-bottom: 5px;">More 1 of 2</div>
Name	Type	Size	Date & Time	Comment																											
SAMPLE-1	WFM	2996	93-11-11 13:08																												
SAMPLE-2	WFM	2996	93-11-11 13:10																												
SAMPLE-3	WFM	2996	93-11-11 13:12																												
SAMPLE-4	EQU	452	93-11-11 13:14																												
SAMPLE-4	WFM	2996	93-11-11 13:14																												
Rename	Comment	Copy	Delete	Delete All	Lock On Off																										

Figure 2-40: Initial Menu File List

Creating a Sequence File

In this procedure, you will create a sequence file that combines two files: the waveform file created with the waveform editor (**SAMPLE-1.WFM**) and the waveform file created with the equation editor and then compiled (**SAMPLE-4.WFM**).

New Sequence

- Step 1:** Select **New Sequence** from the side menu.

Figure 2-41 shows the sequence editor menu.

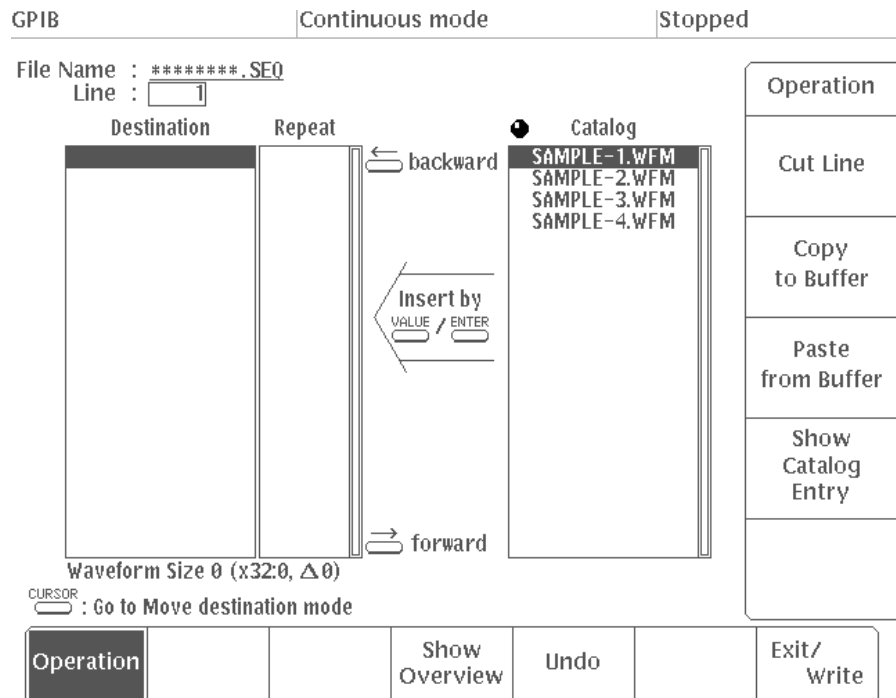

Figure 2-41: Sequence Editor Menu Display

● SAMPLE-1.WFM

VALUE
○

2 ENTER
○ ○

- Step 2:** Use the general purpose knob to select the waveform file from the **Catalog** to go on the first line of the **Destination** list. Select **SAMPLE-1.WFM** here.

- Step 3:** Press the **VALUE** button on the front panel.

The file **SAMPLE-1.WFM** will be inserted in the first line of the **Destination** list. The inverted video cursor will move to the **Repeat** column on the same line.

- Step 4:** Now you will set the repetition count for the **SAMPLE-1.WFM** file to 2.

Press "2" and **ENTER** in that order. The inverted video cursor will move to the second line in the **Destination** list.

● SAMPLE-4.WFM

- **Step 5:** Repeat Steps 2 through 4 to enter **SAMPLE-4.WFM** in the second line of the **Destination** list. The repetition count for this file should be set to 1; since this is the default value, there is no need to change it.

This completes the creation of the waveform sequence file. Figure 2-42 shows the resultant display.

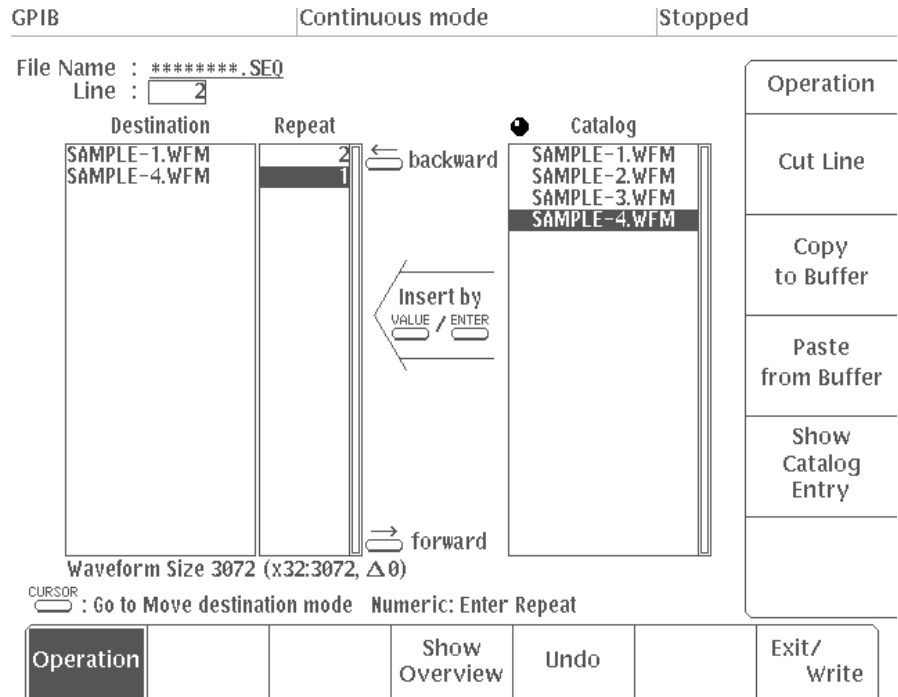

Figure 2-42: Sequence Example

Show Overview

- **Step 6:** Select **Show Overview** from the bottom menu to verify the sequence waveform.

The sequence waveform is combined as the sequence: **SAMPLE-1.WFM** twice and **SAMPLE-4.WFM** once. See Figure 2-43.

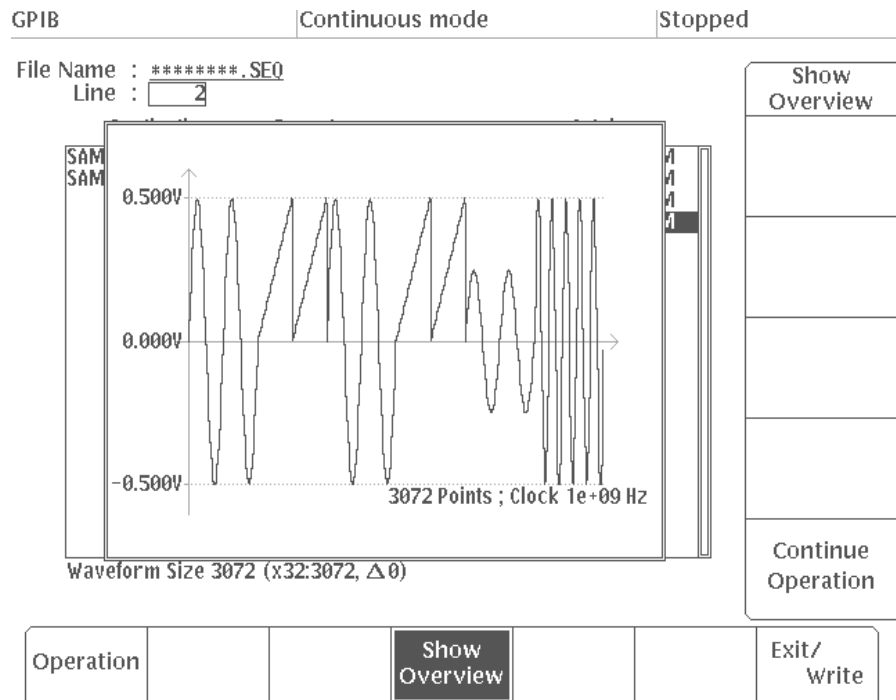

Figure 2-43: Sequence Waveform Display With Show Overview Selected

Continue
Operation

- Step 7:** After verifying waveform, select **Continue Operation** from the side menu to return the system to the previous sequence edit menu.

Exit/
Write

- Step 8:** Select **Exit/Write** from the bottom menu.

Write and
Exit

- Step 9:** Select **Write and Exit** from the side menu.

O.K.

- Step 10:** Input **SAMPLE-5** as the name for this sequence file. For details on how to input the file name, see Step 24 in Example 3 in "Creating a waveform file."
- Step 11:** When you are finished inputting the file name, select **O.K.** from the sub-menu. The sequence (**SAMPLE-5.SEQ**) file is saved to internal memory and the system returns to the initial menu.

Creating An Autostep File

In this operation, you will program waveforms to be output, using the files you have created in the previous operations, to form an autostep file.

New
Autostep

- Step 1:** Select **New Autostep** on the second page of the side menu in the initial **EDIT** menu. Figure 2-44 shows the autostep editor menu.

NOTE. Select **More** from the side menu to display the next page.

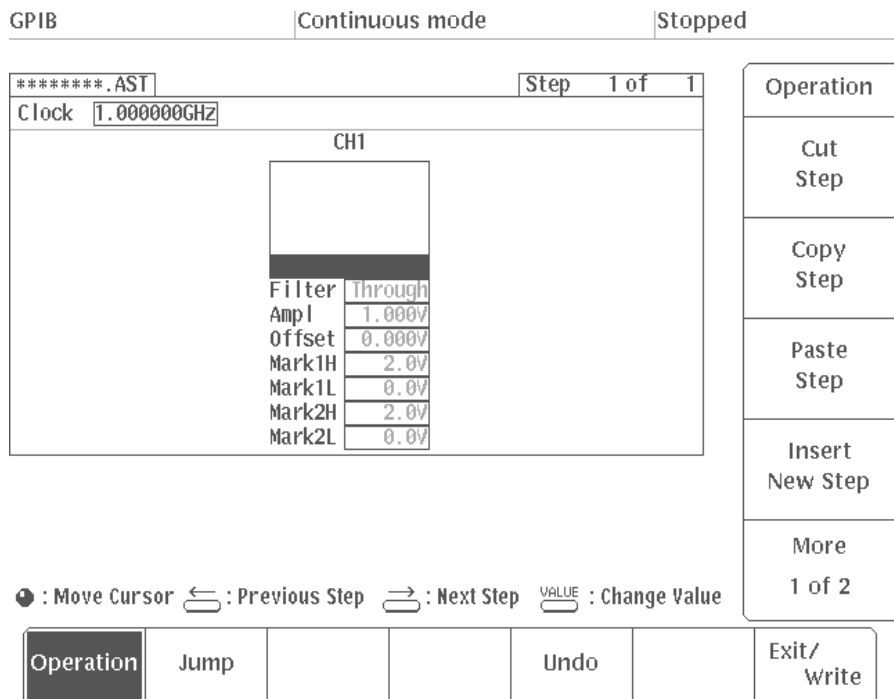

Figure 2-44: Autostep Editor Menu Display



You will set the file for Step 1.

- Step 2:** Press the **VALUE** button on the front panel.

The list used to select waveforms or sequence files will appear.

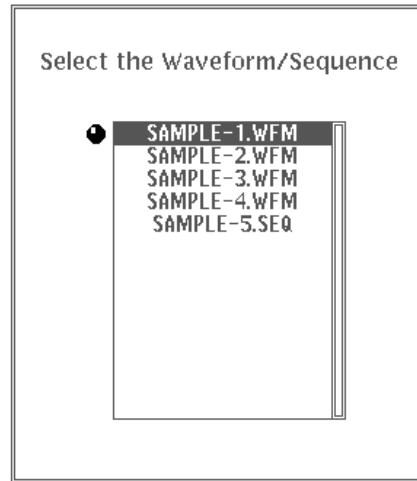
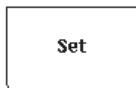

Figure 2-45: File List

- SAMPLE-1.WFM



- Step 3:** Using the general purpose knob, select the **SAMPLE-1.WFM** file.

- Step 4:** Select **Set** from the side menu.

The waveform and output parameters for the **SAMPLE-1.WFM** file will appear.

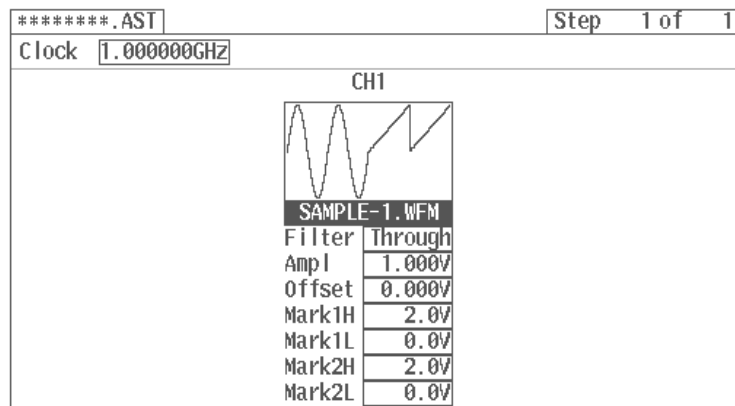

Figure 2-46: Setting Files

More
1 of 2

Append
New Step

You will now set the file for Step 2.

Step 5: Select **More 1 of 2** from the side menu to display the second page of the side menu.

Step 6: Select **Append New Step** from the side menu.

The Step 2 display will appear.

Step 7: Using the procedure described in Steps 2 – 4 above, set the files for Step 2.

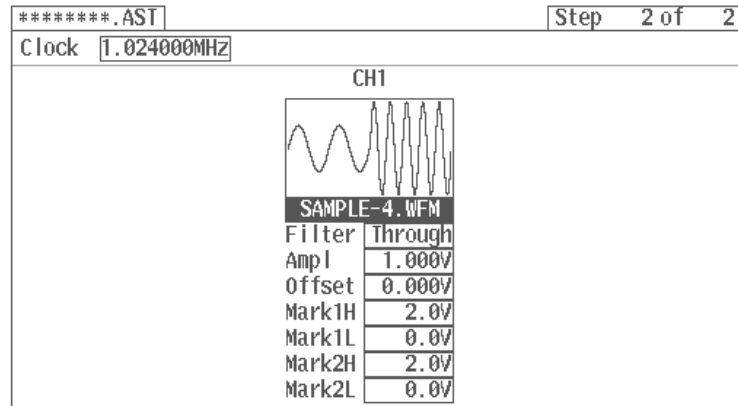

Figure 2-47: Setting the Files for Step 2

Exit/
Write

Write and
Exit

O.K.

Step 8: Select **Exit/Write** from the bottom menu.

Step 9: Select **Write and Exit** from the side menu.

Step 10: Enter **SAMPLE-6** as the name for the autostep file. For details on how to input the file name, see Step 24 in Example 3 in "Creating a waveform file."

Step 11: When the file name has been entered, select **O.K.** from the sub-menu.

The autostep file that you have created will be saved in the internal memory under the name **SAMPLE-6.AST** and the initial menu will reappear.

Setting the Output Parameters

SETUP

- Step 1:** Press the **SETUP** button in the **MENU** column. Figure 2-48 shows the **SETUP** menu displayed.

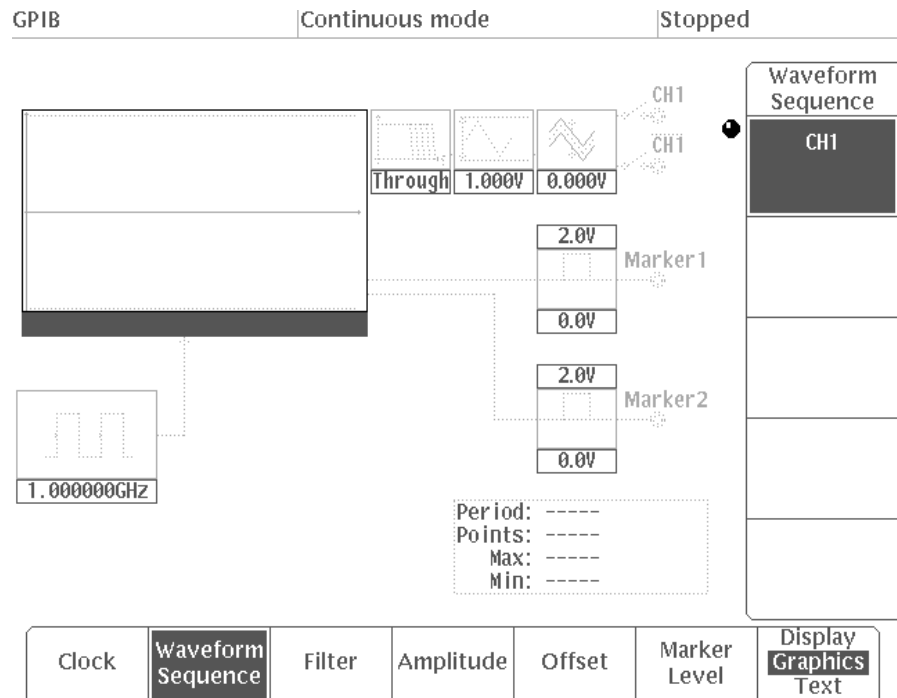



Figure 2-48: SETUP Menu

Waveform Sequence

SAMPLE-1.WFM

ENTER



Clock

Internal Clock

1 0 2 4 KHz/ms/mV

- Step 2:** Select **Waveform Sequence** from the bottom menu.
- Step 3:** Turn the general purpose knob to select the **SAMPLE-1.WFM** file.
- Step 4:** Press the **ENTER** button on the front panel.
- Step 5:** Select **Clock** from the bottom menu.
- Step 6:** Select **Internal Clock** from the side menu.
- Step 7:** Use the numeric and unit keys to input **1, 0, 2, 4, kHz**, in order, to set the clock frequency to 1.024 MHz.

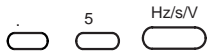
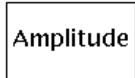
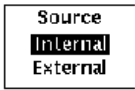
Operating Examples



Step 8: Press the **Source** button in the side menu to select **Internal**.

Step 9: Select **Amplitude** from the bottom menu.

Step 10: Use the numeric and unit keys to input ".", **5**, **V**, in order, to set the voltage value for full vertical scale.

Figure 2-49 shows the menu displayed as a result of these settings.

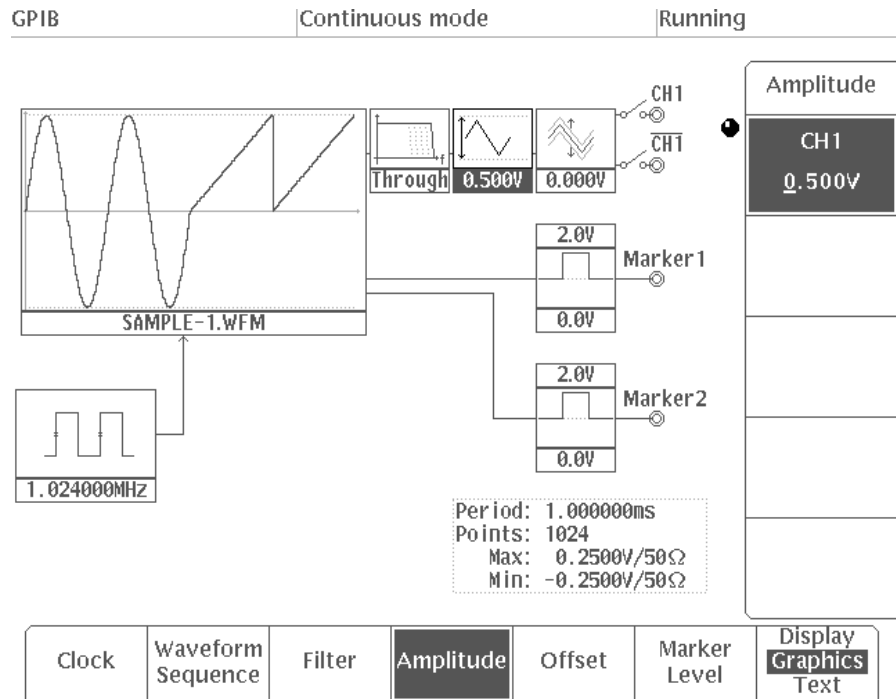

Figure 2-49: Setting Output Parameters

This completes the output parameter setting.

Setting Operation Mode and Waveform Output

Now use an oscilloscope to see what type of waveform is generated. Connect the AWG2041 to an oscilloscope using 50 Ω cables and 50 Ω terminations as shown in Figure 2-50. The waveform output for this instrument is calibrated for a 50 Ω load.

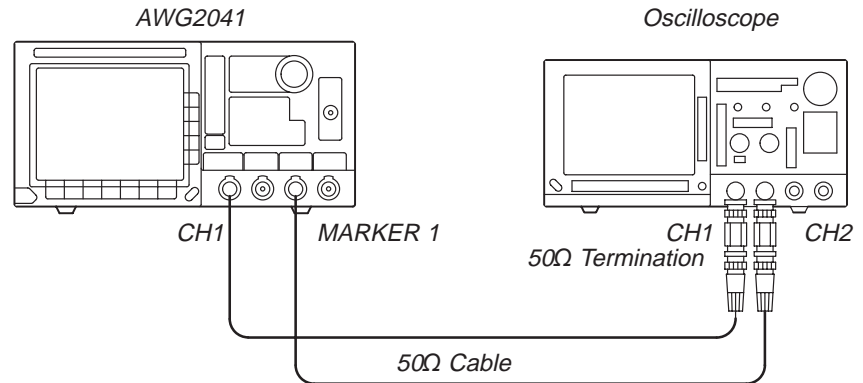

Figure 2-50: Connections for Example 3

Continuous Mode

Set the operation mode to **Cont.**



- Step 1:** Press the **MODE** button in the **MENU** column. Figure 2-51 shows the **MODE** menu.

GPIB | Continuous mode | Running

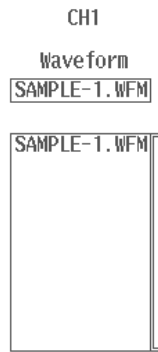

Figure 2-51: MODE Menu



- Step 2:** Select **Cont** from the bottom menu.

This operation mode continuously outputs the set waveform. Also, "Running" is displayed in the trigger status area on the upper right section of the screen to show that the set waveform is being output.

- Step 3:** Press the **CH1** On/Off button on the front panel to enable waveform output.

When the output is On, the On/Off indicator lights up. This operation outputs the specified waveform from the **CH1** output connector. Set the oscilloscope appropriately to display the waveform on the oscilloscope screen.

You can use the marker output from the front panel of the instrument as the external trigger for the oscilloscope. The marker signal is high at the 0 point of the waveform for the default value. See Figure 2-52. The marker signal can be set to any point using the waveform edit function.

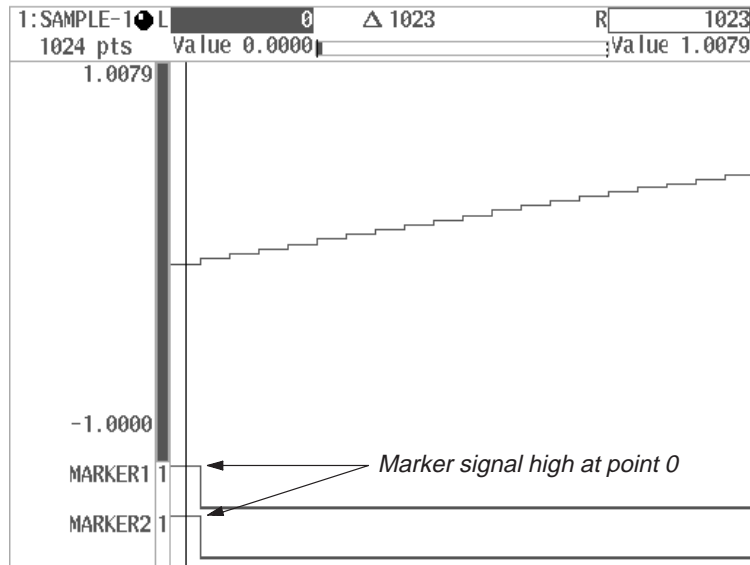

Figure 2-52: Setting the Marker Default

Triggered Mode

In the following steps, set the operation mode to **Triggered** and generate the trigger signal with the **TRIGGER MANUAL** button to control the waveform output.

Triggered

- Step 4:** Select **Triggered** from the bottom menu.

When you select this item, the side menu lists external trigger parameters which allow you to set them. Figure 2-53 shows the menu set for **Triggered** mode.

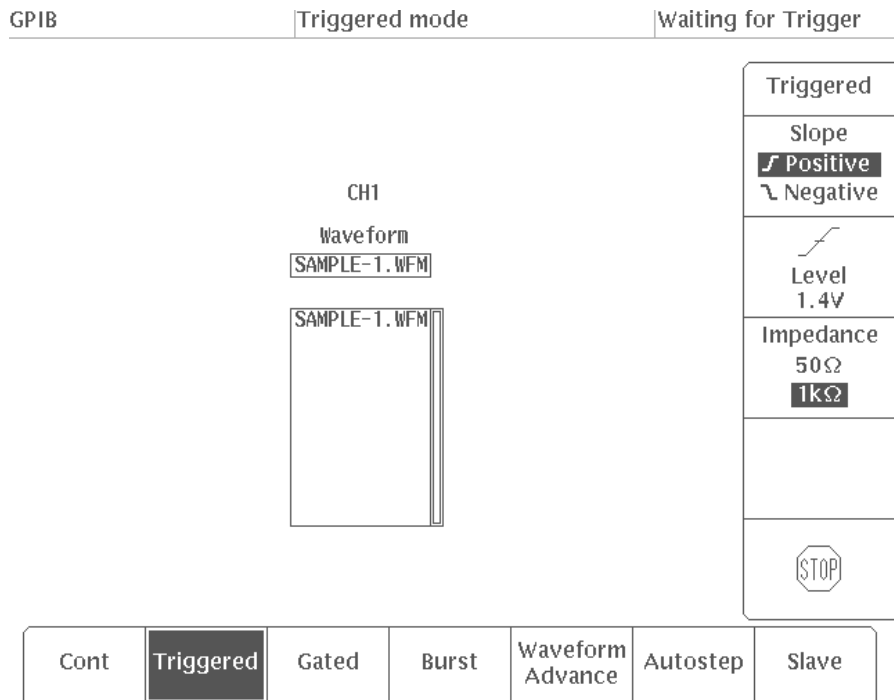

Figure 2-53: Menu Display When Triggered is Selected

Figure 2-54 shows the **MANUAL** button and the **TRIGGER INPUT** connector for inputting an external trigger signal.

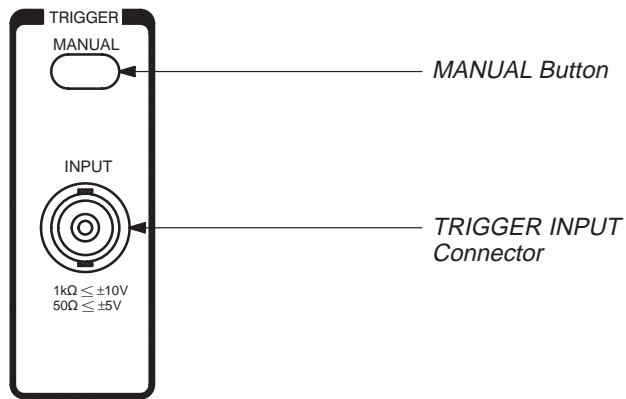

Figure 2-54: MANUAL Button and TRIGGER INPUT Connector

This procedure does not use an external trigger signal. Rather, it generates the trigger signal when the **MANUAL** button is pressed.

MANUAL

Step 5: Press the **MANUAL** button.

Check the oscilloscope to see that each time you press the **MANUAL** button, a set waveform is output once.

Autostep Mode

Using the following procedure, you can set the operation mode to **Autostep** and use the **MANUAL** button to generate a trigger signal and control step waveform output.

NOTE. When the operation mode is set to **Autostep**, it is not possible to change the output parameters in the **SETUP** menu.

Autostep

- Step 6:** Select **Autostep** from the bottom menu.

The menu shown in Figure 2-55 will appear.

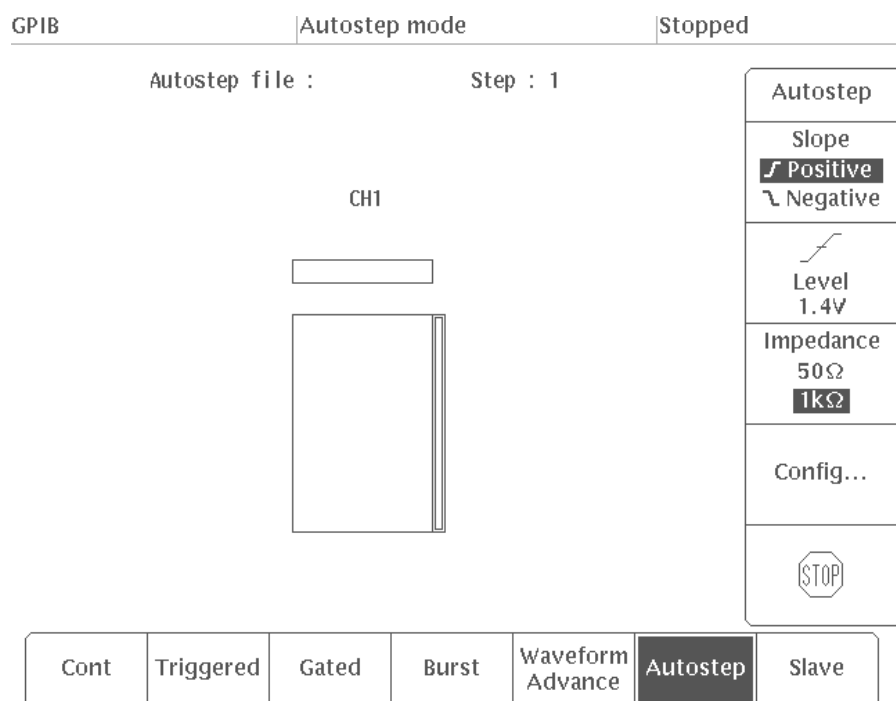

Figure 2-55: Menu Display When Autostep is Selected

Config...

- Step 7:** Select **Config...** from the side menu.

The **Config...** sub-menu will appear.

Select
Autostep
File

- Step 8:** Choose **Select Autostep File** from the sub-menu.

A list of autostep files will appear.

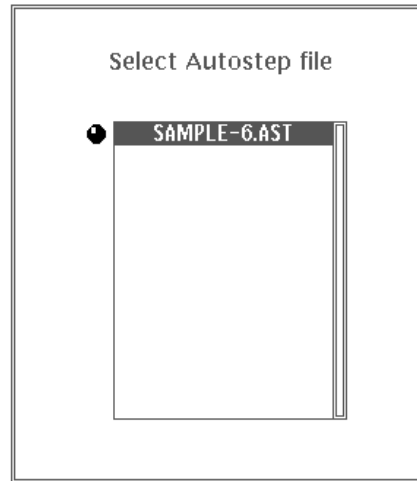
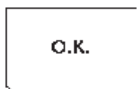

Figure 2-56: Autostep File List

● SAMPLE-6.AST



- Step 9:** Using the general purpose knob, select the **SAMPLE-6.AST** file.

In this example, there is only one file in the list, so it will already be selected.

- Step 10:** Select **O.K.** from the sub-menu.

- Step 11:** Press the **Run** button and select **Continuous** from the sub-menu.

- Step 12:** Press the **CH1** On/Off buttons on the front panel to turn on waveform output.

- Step 13:** Press the **MANUAL** button on the front panel.

After pressing the **MANUAL** button, check on the oscilloscope to make sure the waveform is output.

- Step 14:** Select **Next Step** from the sub-menu.

The waveform will advance to the next step.

- Step 15:** Repeat Steps 13 and 14 to output all of the waveforms in the autostep file.

This completes the Example 3.

Example 4: Loading and Saving Files

NOTE. When the instrument is switched off, the data in the internal memory is erased. Accordingly, it is necessary to copy any files that have been created or edited onto a floppy disk or into the instrument's internal non-volatile memory (NVRam).

In Example 4, you will load and save the file created in the previous operation.

LOAD menu

Used to enter files from a floppy disk or the instrument's internal NVRam into the internal memory.

SAVE menu

Used to save files that have been created or changed onto a floppy disk or the instrument's internal NVRam.

Saving Files

To save files into internal non-volatile memory (NVRam), perform the following steps:

LOAD/SAVE

Device

NVRam

Save

Step 1: Press the **LOAD/SAVE** button in the **MENU** column.

Step 2: Select **Device** from the bottom menu.

Step 3: Select **NVRam** from the side menu.

Step 4: Select **Save** from the bottom menu.

Figure 2-57 shows the **SAVE** menu displayed.

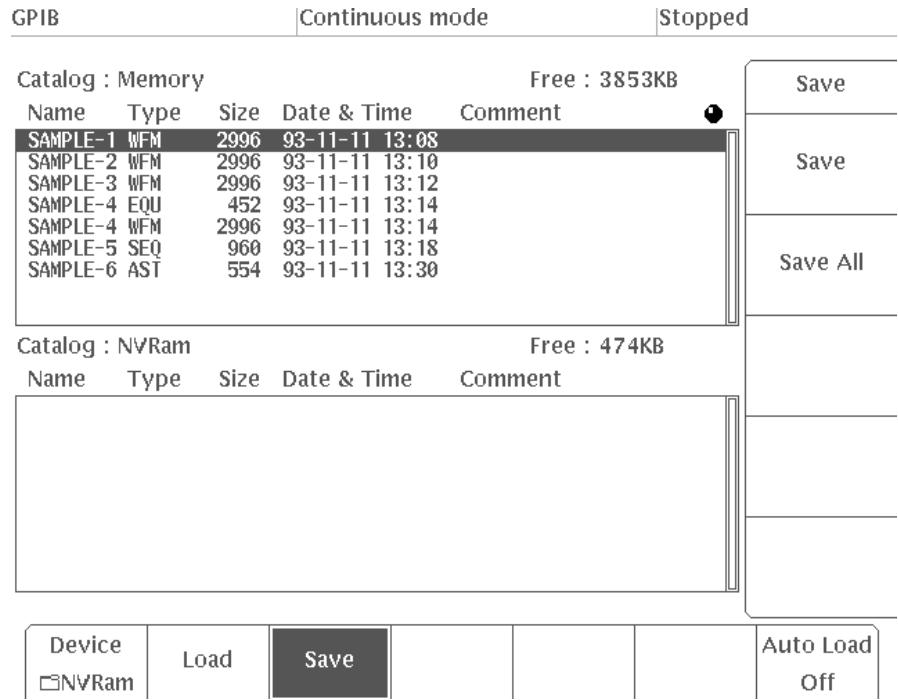

Figure 2-57: SAVE Menu

Save All

- Step 5:** Select **Save All** from the side menu.

When **Save All** is selected, all the files in internal memory (listed in the upper screen) are saved to the NVRam. See Figure 2-58.

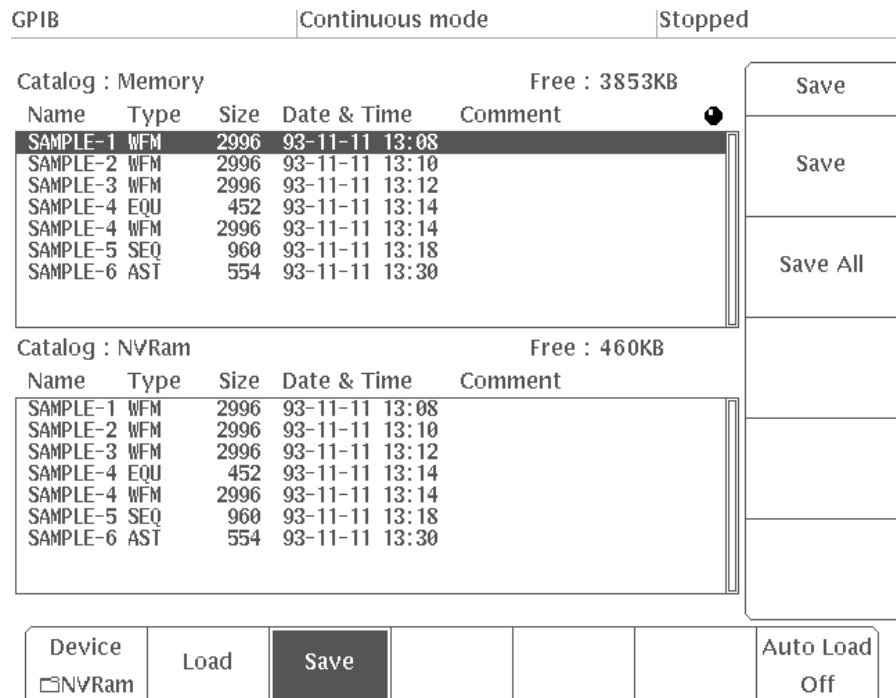

Figure 2-58: Files Saved in NVRam

When **Save** is selected from the side menu, only the file displayed inverted in the internal memory list is saved to NVRam.

- Step 6:** Check to make sure that **Auto Load** in the bottom menu is **Off**.

If it is not **Off**, select **Auto Load** from the bottom menu, then select **Off** from the side menu.

- Step 7:** Power the instrument off, then on again.

Loading Files

The following procedure loads files into internal memory.

- Step 8:** Press the **LOAD/SAVE** button in the **MENU** column.

Make sure that there are no files in the internal memory file list in the upper screen (see Figure 2-59).

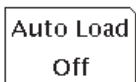

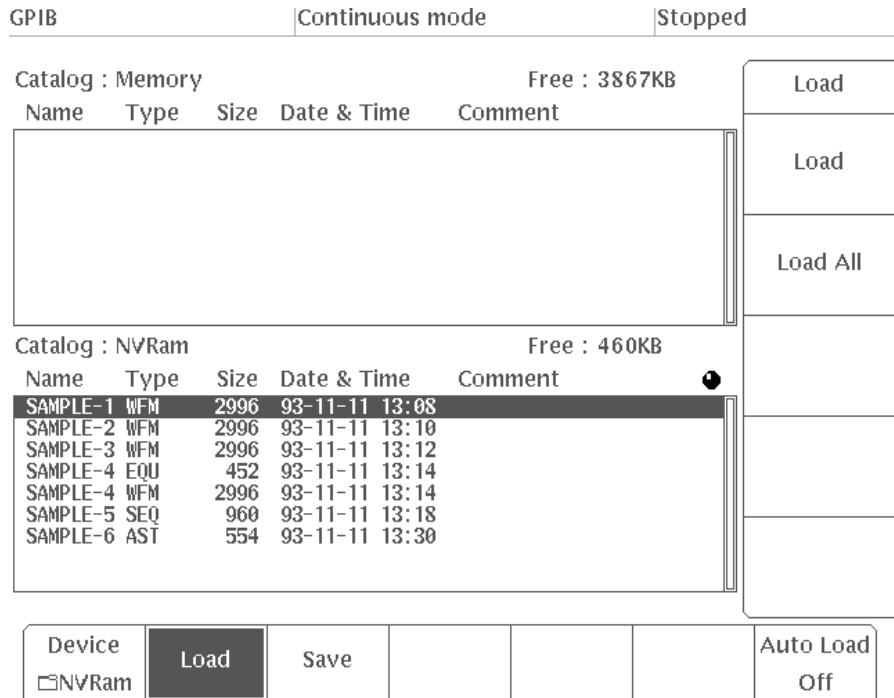
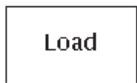

Figure 2-59: Internal Memory File List



Step 9: Select **Load** from the bottom menu.
Here **NVRam** is selected in the **Device** bottom menu.

Step 10: Select **Load All** from the side menu.
When this item is selected, all the files in the NVRam (listed in the lower screen) are loaded into internal memory. See Figure 2-60.

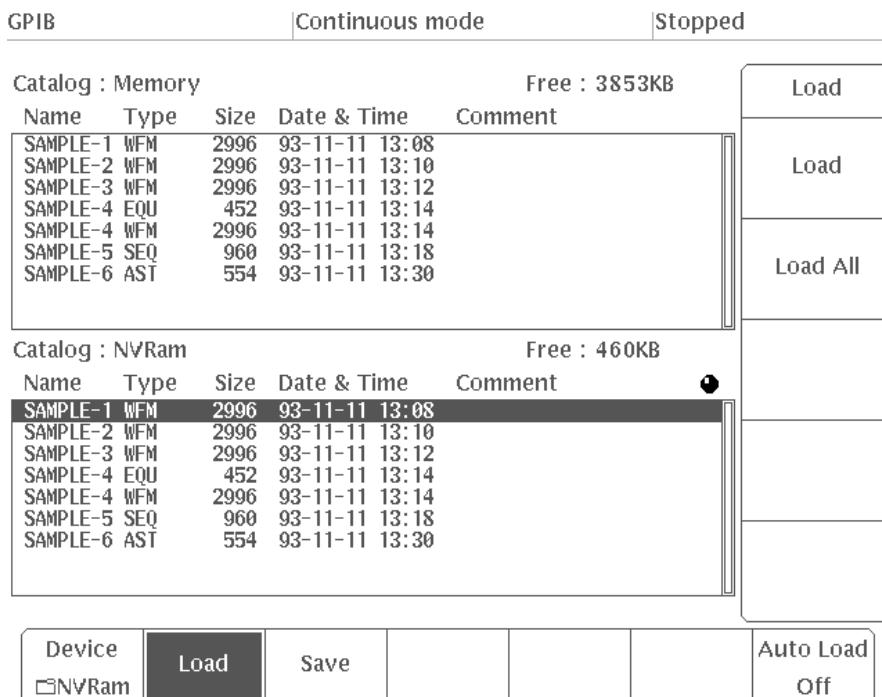

Figure 2-60: Files Loaded into Internal Memory

When you select **Load** from the side menu, the file displayed in inverted video in the NVRam list is loaded into internal memory.

Auto Load

Using the **Auto Load** process, it is possible to automatically load files from a designated device into the instrument’s internal memory when the power to this instrument is turned on. You can do this with the following procedure:

- Step 11:** Select **Auto Load** from the bottom menu.

- Step 12:** Select **from NVRam** from the side menu.

- Step 13:** Power the instrument off, then on again.

Check to make sure that the designated files were loaded from the NVRam to the internal memory when the power to this instrument was turned on.

This completes the Example 4.

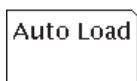

Also, note that files are loaded/saved in the same manner when the **Device** is set to **Disk**. For a floppy disk, hierarchical file structures can be created using directories. See the explanation in "Using the Disk Menu" in Section 4E, "UTILITY Menu."

NOTE. *You must format new floppy disks. For further information on formatting disk, see the explanation in "Using the Disk Menu" in Section 4E, "UTILITY Menu."*

Example 5: Loading Waveforms From Other Instruments

This instrument can transfer waveforms via a GPIB cable from a digital storage oscilloscope (DSO), etc. See page 4D-7 for a list of instruments from which waveforms can be transferred.

In Example 5, you will transfer waveforms from a Tektronix TDS series digital storage oscilloscope.

- Step 1:** Connect the AWG2041 and the other instruments as shown in Figure 2-61.

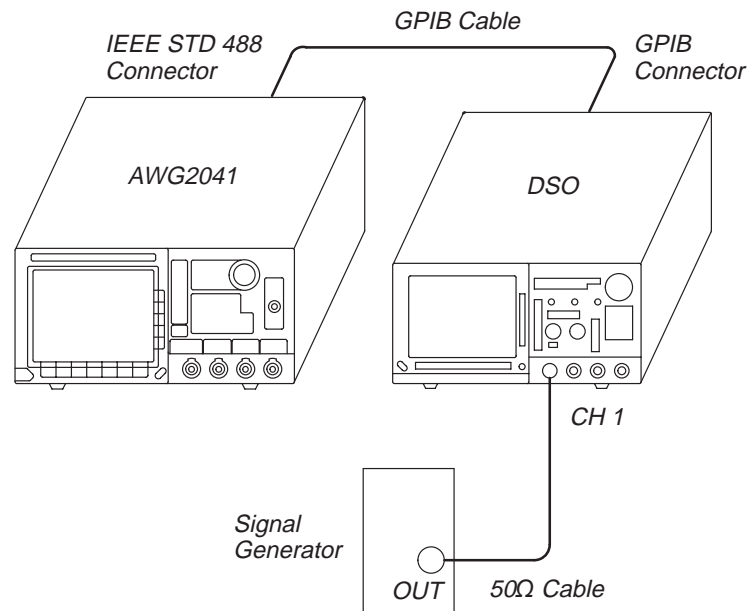

Figure 2-61: Connections for Example 5

- Step 2:** Adjust the amplitude of the signals from the signal generator so that the waveform is displayed on the DSO screen with the amplitude and sweep speed shown in Figure 2-62.

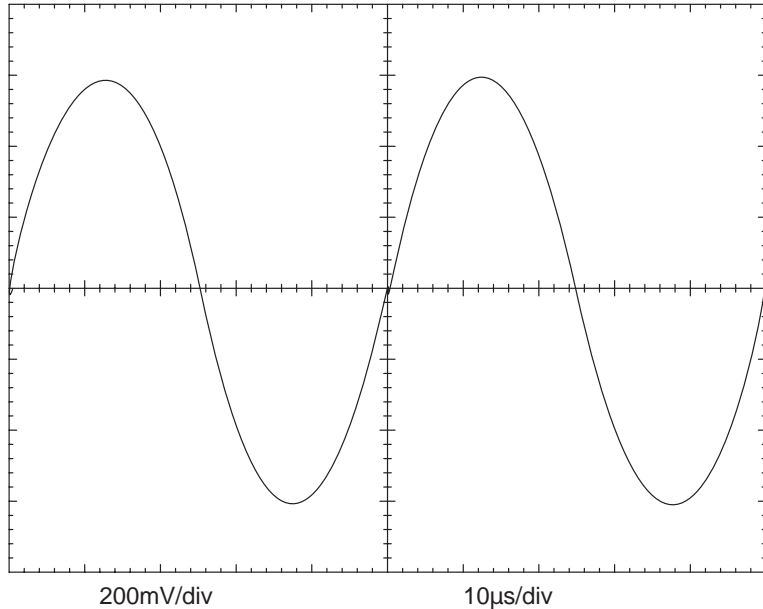

Figure 2-62: DSO Screen

LOAD/SAVE



Device



GPIB

- Step 3:** Press the **MENU** column **LOAD/SAVE** button for the AWG2041.
- Step 4:** Select **Device** from the bottom menu.
- Step 5:** Select **GPIB** from the side menu.

At this point, if the remote port is not **GPIB** or the GPIB is not configured for waveform transferring, the message shown in Figure 2-63 will appear. Select **O.K.** from the sub-menu to change these settings for making transfer possible.

The GPIB configuration is not "Waveform Transfer" and the Remote Port is not "GPIB".
Are you sure of changing the parameters to match the transfer operation ?

Figure 2-63: Confirmation Message (asking if it is O.K. to change the remote port and GPIB configuration settings)

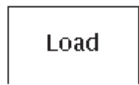

● Tek TDS CH1

Step 6: Select **Load** from the bottom menu.

Step 7: Use the general purpose knob to select the name of the DSO instrument connected to the AWG2041 and the transferring source from the **Name** column in the **GPIB Source** list. In this example, you should select "**Tek TDS CH1**." See Figure 2-64.

Catalog : GPIB Source

Name	Loaded as
Tek TDS CH1	TDSCH1 WFM
Tek TDS CH2	TDSCH2 WFM
Tek TDS CH3	TDSCH3 WFM
Tek TDS CH4	TDSCH4 WFM
Tek TDS REF1	TDSREF1 WFM
Tek TDS REF2	TDSREF2 WFM
Tek TDS REF3	TDSREF3 WFM
Tek TDS REF4	TDSREF4 WFM
Tek 2400 CH1	2400CH1 WFM

Figure 2-64: GPIB Source List

Step 8: Set the DSO GPIB address to 1 and its communication mode to talk/listen.

NOTE. If the DSO GPIB debug mode is On, a time out error may occur. If so, switch off the debug mode.



● 1

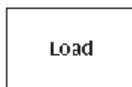

Step 9: Choose **Select Source Address** from the side menu.

Step 10: Use the general purpose knob to set the address to 1 which is the same as the GPIB address of the load source DSO.

Step 11: Select **Load** from the side menu.

When this is done, the waveform data will be transferred from the DSO instrument to the AWG2041. The transferred waveform data will be loaded into the internal memory of the AWG2041 under the name shown in the "**Loaded as**" column of the **GPIB Source** list. In this example, the waveform file is named "**TDSCH1.WFM**". The clock, amplitude, and offset values obtained from the waveform preamble are loaded into the waveform file as setup data, together with the waveform data.

NOTE. *If the amplitude, offset, or clock is outside the range that can be set for the AWG2041, it is replaced with the maximum or minimum value that can be set. If an attempt is made to transfer a waveform that exceeds any of these ranges, a message to that effect is displayed.*

Load
Without
Preamble

If **Load Without Preamble** in the side menu is selected, the waveform preamble will not be loaded (in other words, only the waveform data will be loaded). In such cases, all parameters will be set to their default values.

This completes the Example 5.

Example 6: Using the Waveform Function Generator

The instrument is equipped with a waveform function generator for generating simple waveform functions. Pressing the **F.G** button on the front panel will change the mode to function generator (**FG**) mode and enable you to set various waveform parameters.

In Example 6, select pulse wave and set the following parameters:

Frequency 1 MHz
 Amplitude 1V
 Offset 0.5
 Duty ratio 30%.



- Step 1:** Press the front panel **F.G** (Function Generator) button. The **FG** mode menu is displayed.

Waveform Settings

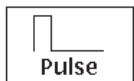

- Step 2:** Select **Pulse** from the bottom menu.

Figure 2-65 shows a pulse waveform displayed within the frame on the screen.

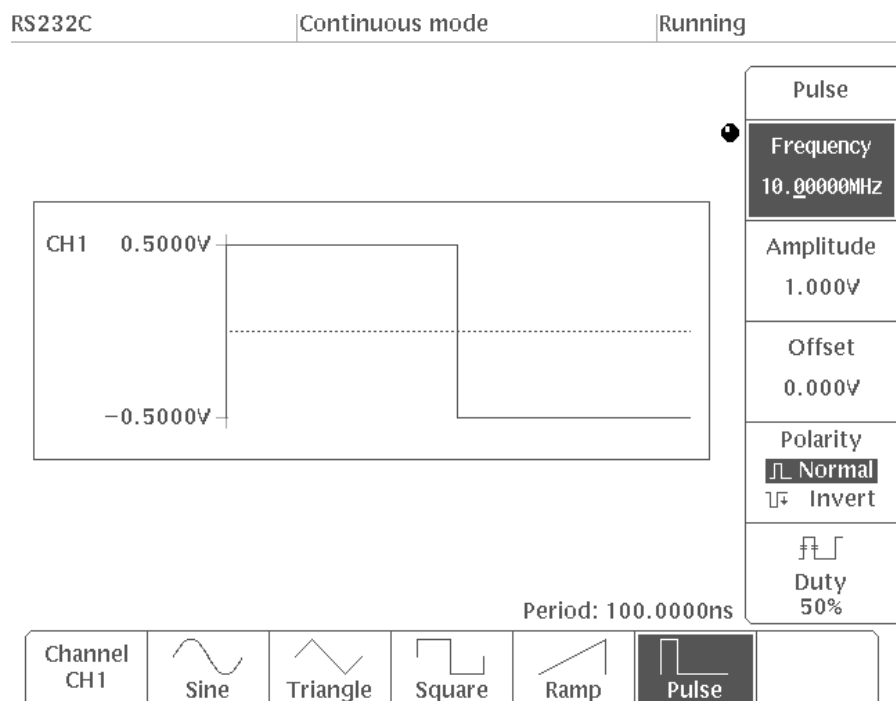
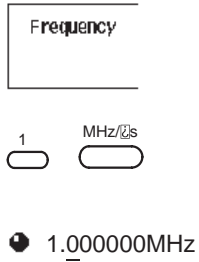

Figure 2-65: Screen When Pulse Set

Operating Examples



Set the frequency to 1 MHz.

Step 3: Select **Frequency** from the side menu.

Step 4: Press **1**, and the **MHz/μs** key to input the frequency with the numeric keys and unit key.

Step 5: To set the frequency with the general purpose knob, select the index digit for input with the arrow buttons (←/→) on the front panel. Press the ← button to move the underscore to the left or press the → button to move the underscore to the right. Turn the general purpose knob with the index digit selected to get a 1 MHz frequency.

You will set the amplitude to 1 V, the offset to 0.5 V and the duty ratio to 30%.

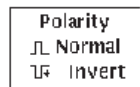
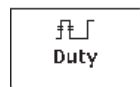
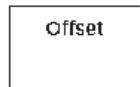

Step 6: Select **Amplitude** from the side menu.

Use the general purpose knob or numeric keys to set an amplitude of 1.000 V.

Step 7: Select **Offset** from the side menu.

Use the general purpose knob or numeric keys to set an offset of 0.500 V.

Step 8: Select **Duty** from the side menu.

Use the general purpose knob or numeric keys to set a duty ratio of 30%. When using the numeric keys, press **3, 0** and **ENTER** in that order.

Step 9: Check that when you press the **Polarity** button in the side menu, the polarity toggles between **Normal** and **Invert** and the polarity of the pulse wave on the screen is reversed. Then set the polarity to **Normal**.

Figure 2-66 shows the screen when the output parameters are set for a pulse waveform.

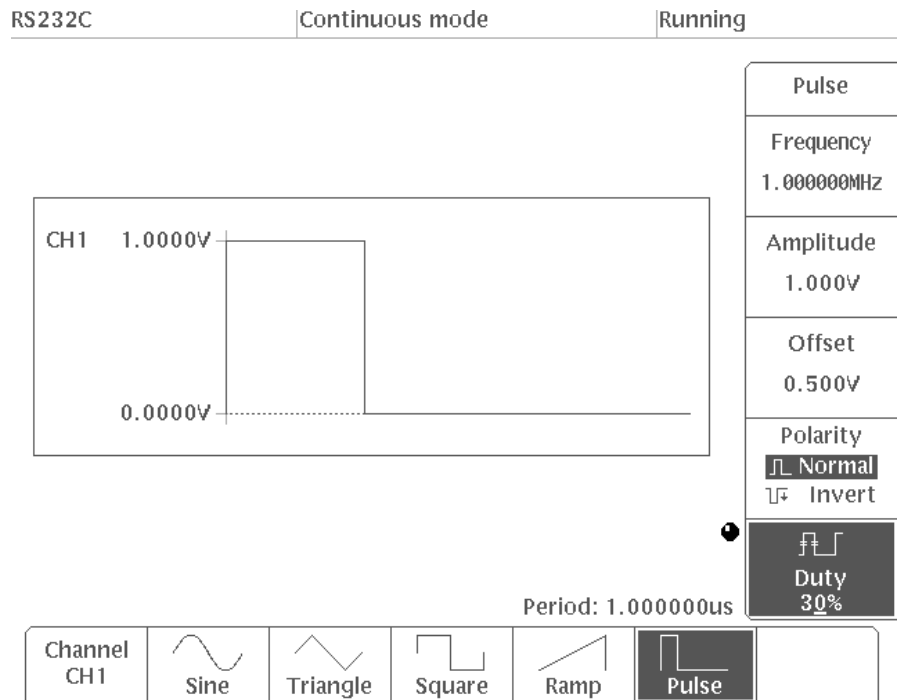

Figure 2-66: Output Parameter Setting Display

This completes the pulse wave output parameter setting. Now you will check the actual waveform on the oscilloscope screen.

Waveform Output

Connect the AWG2041 to an oscilloscope with a 50Ω cable and a 50Ω termination as shown in Figure 2-67. The waveform output for this instrument is calibrated for a 50Ω load.

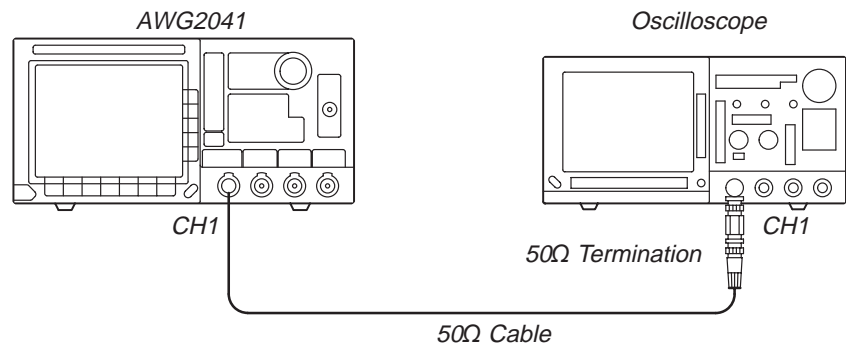

Figure 2-67: Connections for Example 6

Operating Examples



- Step 10:** Press the **CH1** On/Off button on the front panel to switch the output on. The On/Off indicators should light up. In this operation, the waveform outputs continuously from the output connector. Set the oscilloscope appropriately to display the waveform on the oscilloscope screen.

This completes the Example 6.

Functional Operation Summary

Introduction

This summary presents functional block diagrams, explains each block, and gives some operating precautions which are of practical value in understanding the fundamental operating concepts of the AWG2041.

Block Diagram

Figure 3-1 shows a block diagram from the clock oscillator to the DAC. Figure 3-2 shows a block diagram continuing on from Figure 3-1 to output. In subsequent sections, we will discuss each block in detail.

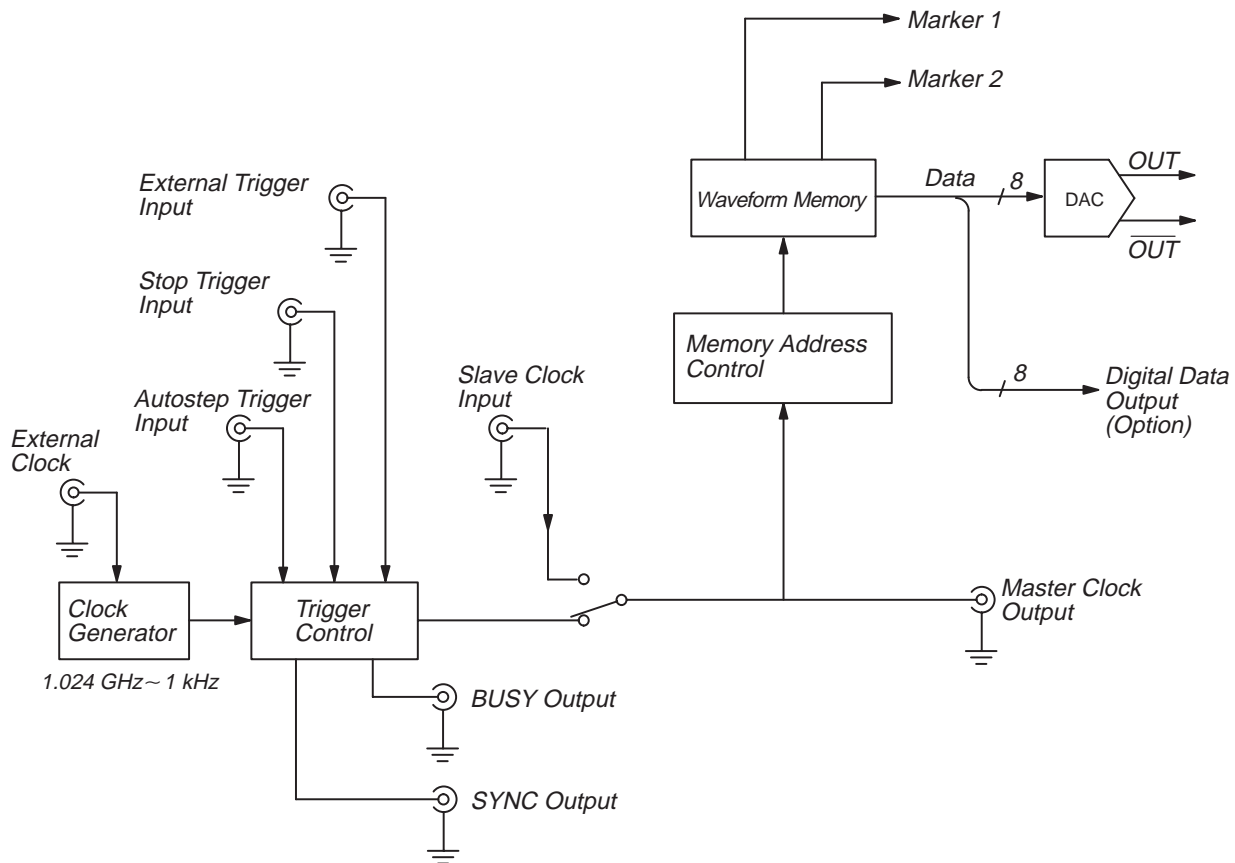

Figure 3-1: Block Diagram (1)

Block Diagram

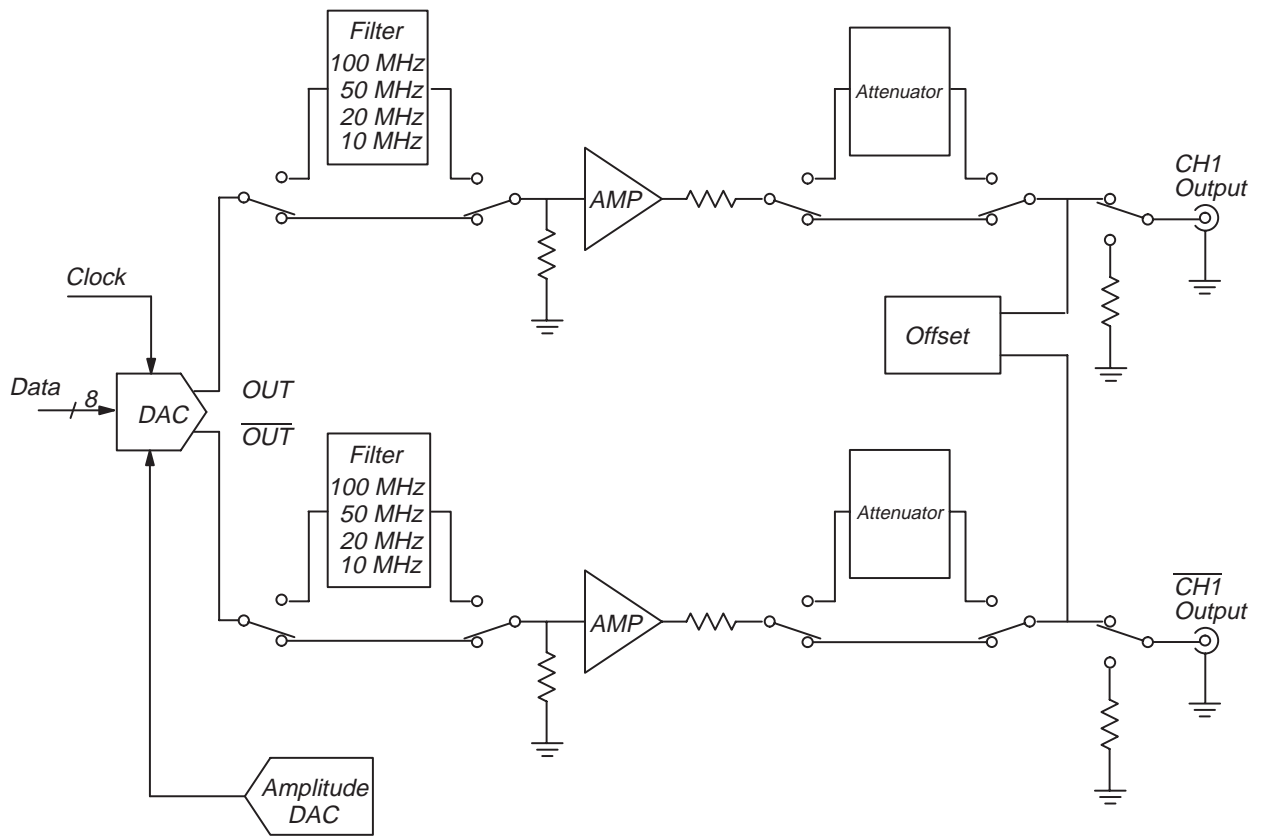

Figure 3-2: Block Diagram (2)

Clock Generator

The **SETUP** menu allows you to choose whether the clock source is internal or external. When internal is selected, it is possible to set the frequency. When external has been selected, the signal connected to the **CLOCK IN** connector on the rear panel will be used as the clock.

The internal clock uses a DDS (Direct Digital Synthesis) clock generator. It uses a divider to create a high-quality clock signal with low jitter and 7-digit resolution between 1.024GHz and 1kHz. Figure 3-3 shows the configuration of the clock generator.

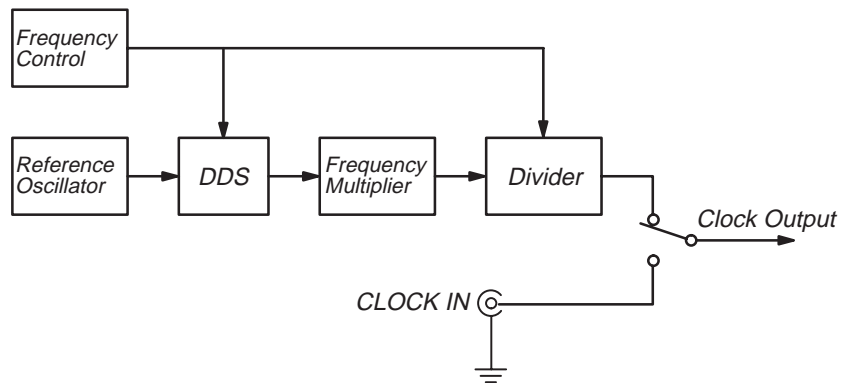

Figure 3-3: Clock Generator

Trigger Control

In trigger control, the operating mode in the **MODE** menu on the AWG2041 is controlled. The signal for the selected clock source is input to this block. Normally the output for the clock generator is used.

Operations in Trigger Mode

Depending on which trigger mode is selected, the following operations are possible:

Cont Mode

The clock signal is sent to the memory address control continuously regardless of whether or not there is a trigger signal.

Triggered and Burst Modes

When an external trigger signal is received from the **TRIGGER INPUT** connector on the front panel, or when a trigger signal is generated by pressing the **MANUAL** button on the front panel, or when a trigger command is entered from the GPIB interface, the clock signal is sent to the memory address control and an output signal synchronous with the trigger signal is generated. The clock signal stops at the end of the waveform.

Gated Mode

A clock signal is sent continuously to the memory address control while the gate signal (either the external gate signal from the **TRIGGER INPUT** connector on the front panel or the signal sent when the **MANUAL** button on the front panel is pressed) is TRUE.

Parallel Operation

When output of two or more channels is required, there are two ways in which this can be achieved: simple parallel operation using marker and external trigger signals, or parallel operation synchronous with the clock signal.

Simple Parallel Operation (1)

Connect the marker output on the master AWG2041 instrument to the **TRIGGER INPUT** connector on the slave instrument. Figure 3-4 shows an example of two instruments connected in this manner.

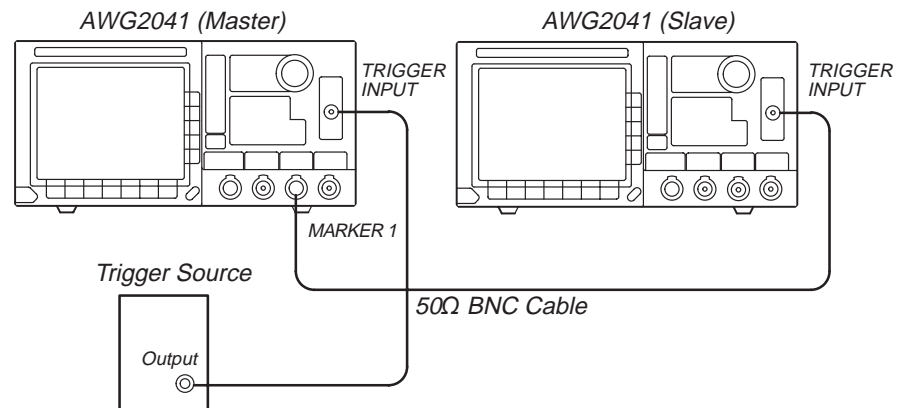

Figure 3-4: Sample Connection 1

NOTE. Marker and signal output will be slightly delayed with respect to the trigger signal. Also, the marker should be set in the editor to be high at the start of the waveform.

Simple Parallel Operation (2)

Figure 3-5 shows a method of connection in which the external trigger signal or gate signal are applied simultaneously to the AWG2041.

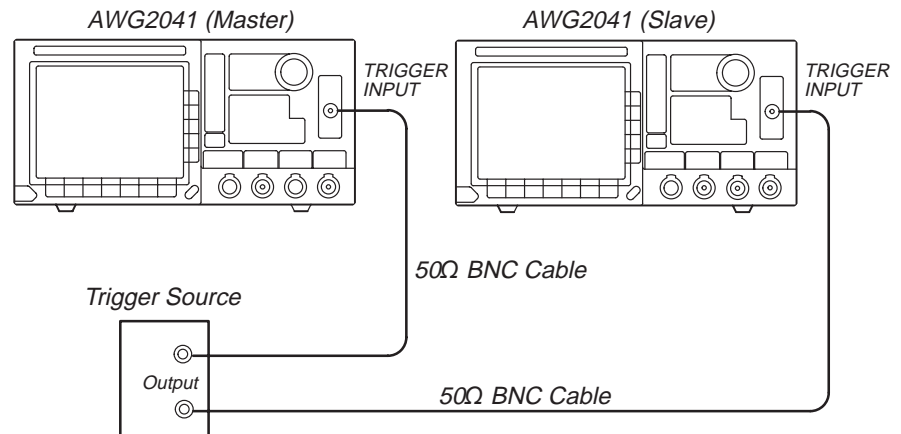

Figure 3-5: Sample Connection 2

NOTE. The 50Ω cables connecting the trigger source to the AWG2041 instruments should be of the same length. When there is only one trigger source output, connect it to the AWG2041 instruments using the shortest 50Ω cables of an identical length and a T-adaptor.

In **Triggered** or **Burst** mode, an output synchronous with the trigger signal can be obtained by applying the external trigger signal simultaneously to the AWG2041 instruments.

Use **Gated** mode when you need a continuous synchronous output for a certain period of time. A synchronous output is created from the time the gate signal is True until it becomes False. To output the waveform again from the beginning, you should reset the output using **STOP** in the side menu.

Parallel Output Synchronous with the Clock Signal

When connecting two or more instruments together for parallel output, use the **MODE** menu to designate one instrument as the master unit (by selecting an operating mode other than **Slave**) and the other as the slave unit (by selecting **Slave** for the operating mode).

As shown in Figure 3-6, the master clock output on the master AWG2041 instrument is connected to the slave clock input on the slave AWG2041 instrument using a 50Ω SMB cable.

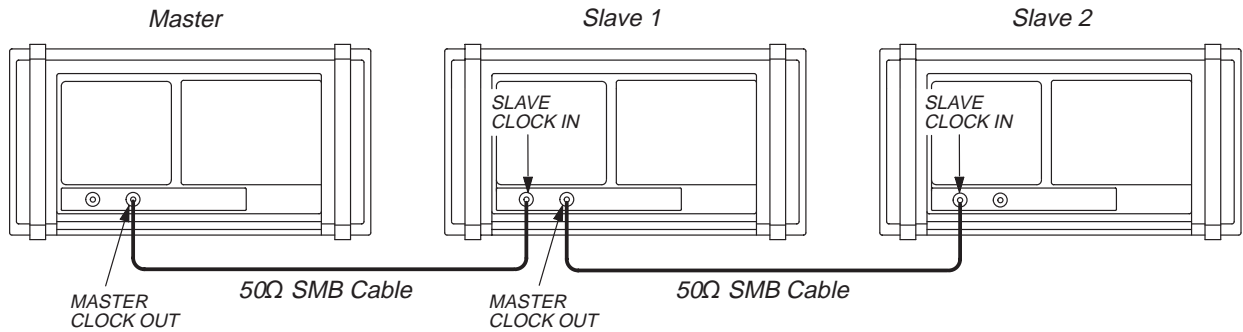

Figure 3-6: Connections for Synchronized Parallel Operation with Three AWG2041

When this is done, the instrument designated as the slave unit operates in the following manner:

The clock signal from the outside that is entered through the **SLAVE CLOCK IN** connector is sent to the memory address control. The clock signal is also sent to the **MASTER CLOCK OUT** connector so it can be used by the other slave instrument. For details, see "Slave Mode" in Section 4C "MODE Menu."

Timing of Trigger Input, Auxiliary Input and Waveform Output

Figure 3-7 shows the output timing relationship among the **SYNC OUT**, **BUSY OUT**, waveform, and **MARKER** signal when a trigger signal is applied from the outside to the AWG2041. For details, see Appendix B "Performance Characteristics."

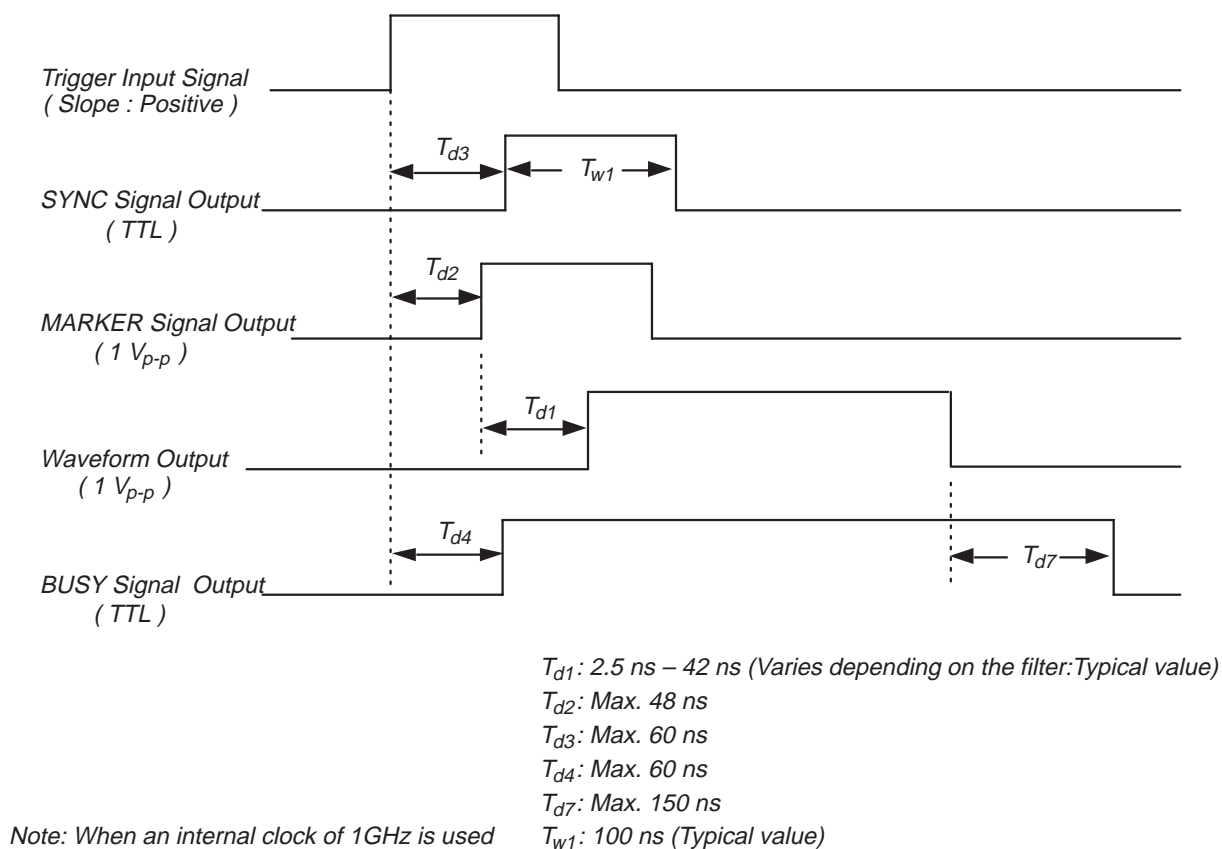

Figure 3-7: Waveform Timing

Memory Control

Memory Address Control

This controls the address locations for outputting waveform data from waveform memory. Operation depends on the **Hardware Sequencer** on/off state as described below.

Figure 3-8 shows a block diagram illustrating the relationship between memory address control and waveform memory.

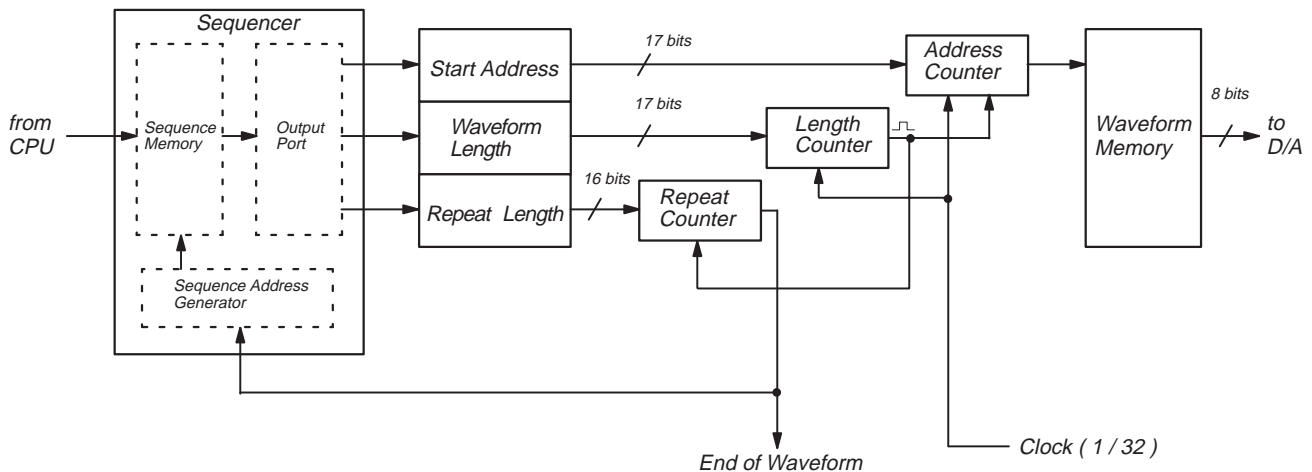

Figure 3-8: Relationship Between Memory Address Control and Waveform Memory

Hardware Sequencer On

When **Hardware Sequencer** is switched on and a sequence file is selected for output, the sequencer is enabled. The sequencer is composed of the Sequence Memory, Sequence Address Generator and Output Port.

The Sequence Memory and waveform memory are loaded at the same time. Each entry in the sequence memory contains the address of a waveform in waveform memory, the length of the waveform, and the repetition number, as specified in the sequence file. The sequence memory can contain 5460 entries.

The contents of the sequence memory entry at the address in the Sequence Address Generator are passed to the Start Address, Waveform Length and Repeat Length registers.

To start the output of a waveform, this information is loaded into the Address, Length and Repeat counters. When the repetition number is greater than one, the Address and Length counters are reloaded each time the waveform completes an output.

The address and length counters operate with a clock signal that is 1/32 of the clock generator. The repeat counter operates each time a waveform completes an output. The End of Waveform signal causes the Sequence Address Generator to increment to the next address, thereby causing the sequence to proceed to the next waveform.

Hardware Sequencer Off

When Hardware Sequencer is switched off, the sequencer is disabled. However, the remainder of the above block diagram functions in much the same way. The Start Address register is loaded with the address of the waveform, and the Waveform Length register with its length. The Burst count is loaded into the Repeat Length register.

The Repeat Counter functions as a Burst Counter. (Reusing the Repeat Counter in this way makes Burst mode possible when Hardware Sequencer is off, whereas it is not possible when Hardware Sequencer is on.)

Waveform Memory

The waveform memory has a capacity of 1 M words, with each word composed of 10 bits. Each bit is composed of four SRAMs of 32k x 8 bits. Of the 10 bits, 8 are used for waveform data and the other two are used for the Marker1 and Marker2 signals.

When a file has been selected with the **Waveform Sequence** item in the **SETUP** menu, the marker data and waveform data that are actually output are stored in this memory.

As the waveform memory must read at a high speed of 1.024 GS/second, the waveform data is multiplexed (subjected to parallel-series conversion) in 32-word increments. For this reason, the memory element itself is operated by a 1/32 clock signal.

The length of the waveform data can be set between 32 points and 1M (or 4M when Option 01 is installed) in multiples of 32. Even when the sequence file has been expanded, the total number of points of waveform data must not exceed 1M (or 4M when Option 01 is installed).

Figure 3-9 shows the configuration of the waveform memory.

Block Diagram

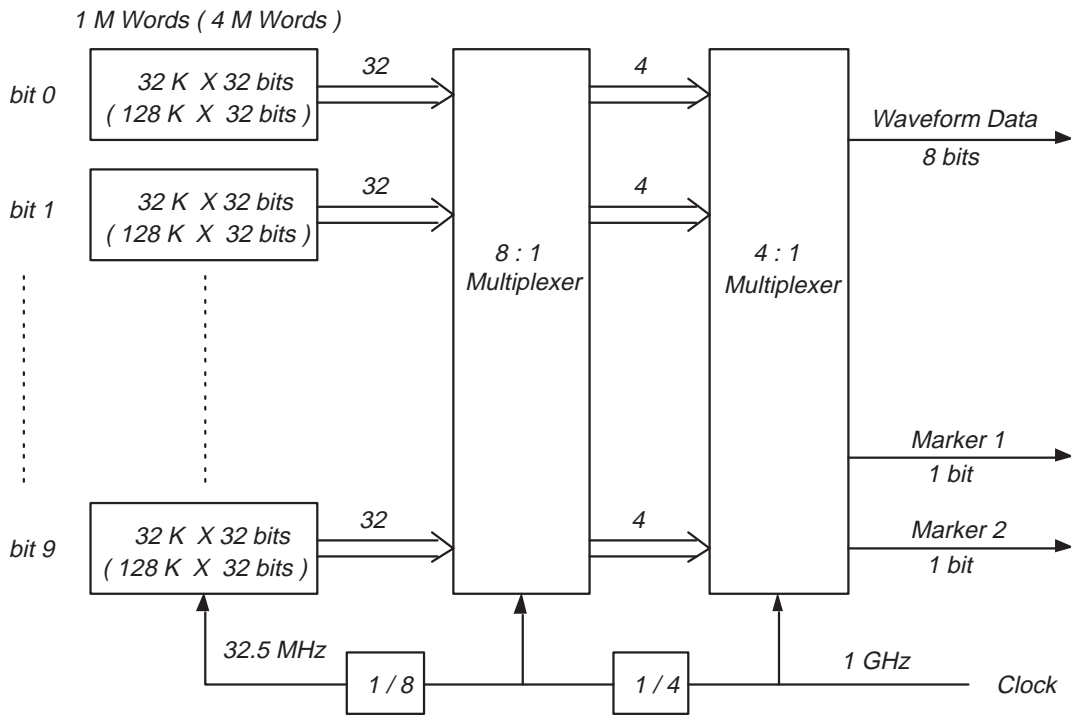

Figure 3-9: Waveform Memory

Loading Sequence Files

When a sequence file has been selected with **Waveform Sequence** in the **SETUP** menu, the contents of the sequence file will be expanded into the 1M words waveform memory (or 4M words waveform memory in the case of Option 01). How the waveforms are expanded into the waveform memory varies depending on the hardware sequencer on or off.

When the hardware sequencer is off and a sequence file has been selected in the **SETUP** menu, the waveform is expanded like a long filmstrip, as shown in Figure 3-10 (Table 3-1 shows an example of a sequence file that contains another sequence).

When the hardware sequencer is on and a sequence file has been selected in the **SETUP** menu, the waveform is expanded in the same fashion as shown in Figure 3-10, except for the number of repetition for each waveform. In this case, the number of repetition is always regarded as 1, regardless of its specification in the sequence file. At the same time, the informations; start address, length and the number of repetition for each waveform are also written in the sequence memory to control the waveforms to be output according to the settings.

Table 3-1: Sample Sequence Files

Sequence File (EXAMPLE.SEQ)	
File Name	Repetition Count
---	---
AAA.WFM	3
XXX.SEQ	4
BBB.WFM	5
---	---

Configuration of XXX.SEQ	
File Name	Repetition Count
CCC.WFM	2
DDD.WFM	1

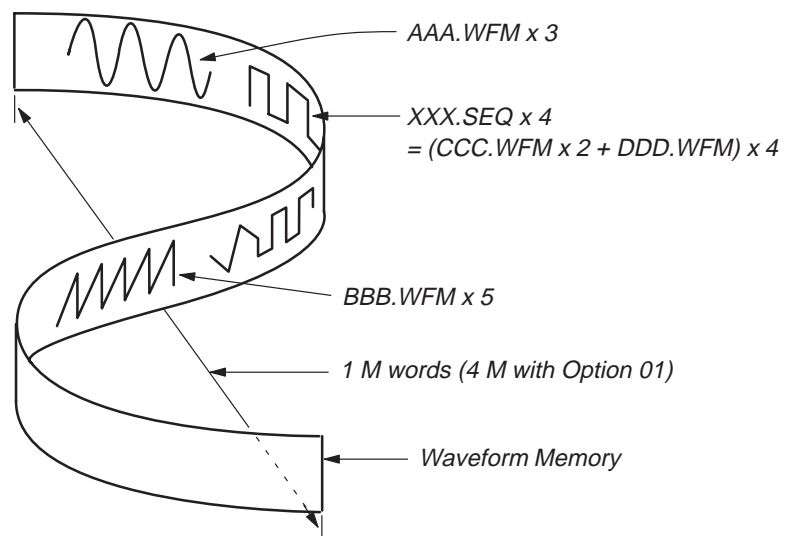

Figure 3-10: Expanding a Sequence File (Hardware Sequencer Off)

Loading Sequence Files in the Waveform Advance Mode

When **Waveform Advance** mode is selected, the loading of waveforms into waveform memory differs depending on the hardware sequencer on/off state.

When the hardware sequencer is off, the memory is divided into a number of segments of equal length, with a waveform loaded into each segment. The lengths of the segments are equal to the smallest multiple of 32 that is greater than or equal to the longest waveform.

When the hardware sequencer is on, waveforms are loaded into memory contiguously. Each waveform will have at least 640 points and have a length that is a multiple of 32 points.

D/A Converter

This is used to convert digital waveform data to an analog signal. It has a resolution of 8 bits. The reference voltage is changed to vary the output voltage continuously.

Digital Data Output (Option 03)

The data and clock signal sent to the DAC pass through an additional buffer as is, after which they are output from the connector on the rear panel.

Data Length

Generally, outputting high precision (high S/N ratio) waveforms requires an adequate number of data points.

For example, when outputting triangular waveforms, 512 points are needed to minimize the jaggedness of the waveform. That is why the AWG2041 uses a DAC with a resolution of 256 (8 bits) for the vertical amplitude.

Figure 3-11 shows the relationship between the triangular wave resolution and the number of data points.

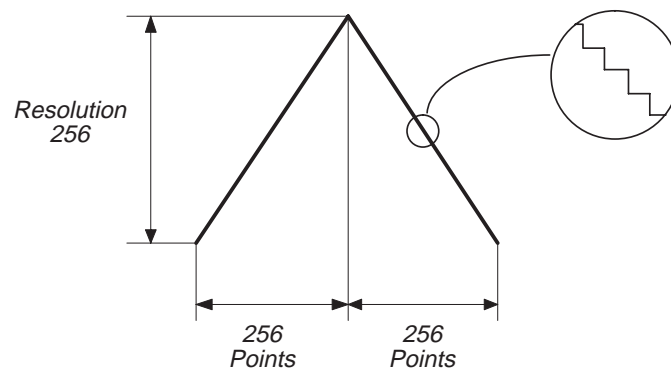

Figure 3-11: Relationship Between Triangular Wave Resolution and Number of Data Points

For a triangular wave, extra waveform points beyond 512 are meaningless. Also, when a 1024-point sine wave is created, the folding component level is approximately -48 dB.

The data length required depends on the waveform shape, the S/N ratio required, the filter cutoff frequency, and other such factors. Therefore, output the waveform on the oscilloscope, spectrum analyzer, or the like, and check that the waveform is what you need.

Analog Circuit

Filter

Four types of low pass filters are provided: 10 MHz, 20 MHz, 50 MHz and 100 MHz. All of these are filters with Bessel characteristics with a gentle shoulder to prevent overshooting or ringing from occurring with respect to the waveform. These filters can be used to remove unnecessary frequency components from the waveform itself or reduce the number of components through folding when the waveform is made up of a limited number of points.

The marker signal is written to the waveform memory in the same manner as waveform data and output passing through the marker output amplifier. The waveform passes through the filter, amplifier and attenuator before being output. Each filter has its own delay time. The difference in time between marker output and waveform output will vary depending on which filter is selected.

Variable Gain, Attenuators

The magnitude of the waveform output is determined by the combination of DAC reference voltage and attenuator. As the voltage dividing ratios of the attenuators are fixed, the reference voltage of the DAC is changed to vary the magnitude continuously.

An attenuation of up to 42 dB is possible, including the change (3 dB) in the reference voltage of the DAC. Figure 3-12 shows the configuration of the attenuators. The attenuators shown in the figure are automatically selected by means of the output voltage setting.

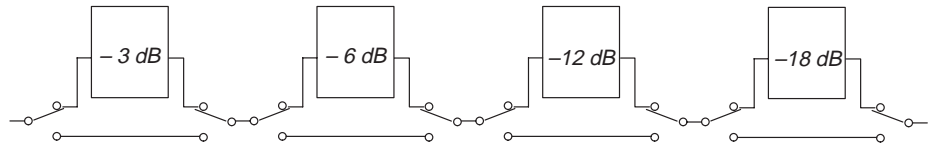

Figure 3-12: Attenuators

Offset

This block is used to apply an offset voltage to the output. The circuit is a current source capable of both discharge and sink; the offset voltage is calculated as an output with accurate 50Ω termination. Figure 3-13 shows the offset circuit.

When this circuit is terminated with 50Ω, an offset of up to $\pm 40\text{mA} \times 25\Omega$ ($50\Omega // 50\Omega$) = $\pm 1\text{V}$ is applied. When not terminated, the signal may be distorted (about $\pm 2.5\text{V}$ or more).

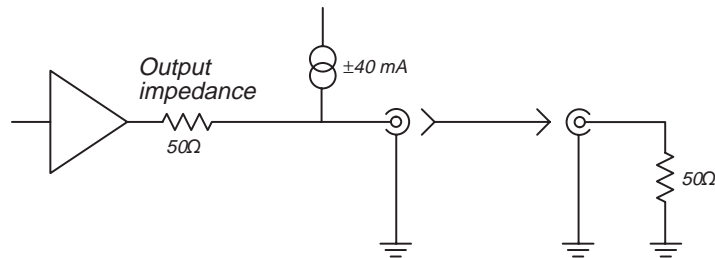

Figure 3-13: Offset Circuit

Reference

Introduction

Sections 4A through 4F will describe in detail the functions contained in each of the menus.

Section 4A **EDIT** Menu
Section 4B **SETUP** Menu
Section 4C **MODE** Menu
Section 4D **LOAD/SAVE** Menu
Section 4E **UTILITY** Menu
Section 4F **FG** Menu

Each section will describe menu functions in the following order:

- **Menu Structure**

Each menu will be shown in a diagram listing the menu items from left to right, with the highest menu level on the left and the lowest menu level on the right. There are three types of menus: the bottom menu, the side menu and the sub-menus. An ellipsis (...) in a side menu item indicates that it has a sub-menu. If a menu has many levels, there will be a "Description" section at the beginning which shows the detailed menu configurations for that function.

- **Menu Functions**

This is a list showing the menu functions and the number of the page on which you can find a description of that function.

- **CRT Display**

This shows a typical screen for that menu and a brief explanation.

- **Description**

This section gives a detailed explanation of the functions in each menu. It includes examples with step-by-step instructions showing how the function is used. Menu items in the text are shown in a bold typeface.

Menu Items Available With Each Editing Function

Menu items for the bottom and side/sub-menus are shown with the words enclosed as shown below to make them easy to distinguish from one another.

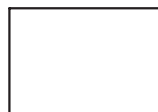

Bottom Menu



Side Menu or Sub-Menu

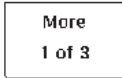

More

When the side menu consists of two or more pages, this item is used to display the next page. In the example shown at left, the side menu being displayed consists of three pages and the first page is currently being displayed.



Go Back

This item is displayed when you select a side menu item that has a sub-menu. It allows you to escape from the sub-menu and return to the side menu level. (The **CLEAR MENU** bezel button can also be used for this purpose.)

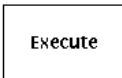

Execute

Select this button to execute the currently selected menu function. For example, in the **Draw...** menu, pressing this button will cause the waveform to be drawn; in the **Shift...** menu, it will cause the waveform to move.

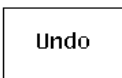

Undo

Select this button to cancel the most previous operation – for example, **Execute**, calculations in the **Math...** sub-menu, or **Marker** settings, or **Cut**, **Paste**, **Insert** or other operation. Pressing Undo again will cancel the **Undo** operation and restore the waveform to the status before Undo was pressed.

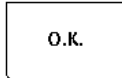

O.K.

Select this button to confirm that you really want to perform an operation, or to respond to a query when a popup menu has appeared. A warning message will appear when it is necessary to confirm an operation in this manner. If you are sure you want to execute the operation, press this **O.K.** button.

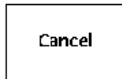

Cancel

This button is usually displayed along with the **O.K.** button. Select it when you want to cancel an operation. (You may also use the **CLEAR MENU** bezel button for this purpose.)

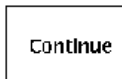

Continue

This item appears in the side menu when a panel containing an error message appears on the screen, or when the **Show Catalog Entry** or **Show Overview** command is used to display a waveform in graphic form. Pressing this button causes the panel to disappear. (You may also use the **CLEAR MENU** bezel button for this purpose.)

EDIT Menu

General Description

To use the AWG2041 to output arbitrary waveforms, you must first create a file for the waveform to be output. There are four file types, each created by a different editor. Files created in this manner will have an extension after the file name that identifies what type of file they are.

Editor	File	Extension
Waveform Editor	Waveform file	.WFM
Equation Editor	Equation file	.EQU
Sequence Editor	Sequence file	.SEQ
Autostep Editor	Autostep file	.AST

Pressing the **EDIT** button in the **MENU** causes the initial menu to be displayed. When you want to edit an existing file or create a new file, you select the appropriate editor from this initial menu. In this section, we will briefly describe these editors.

Waveform Editor

This editor is used to create and edit waveform files. The waveform data display formats are graphic, table, and timing.

Equation Editor

This editor is used to create and edit equation files. Equation file data takes the form of mathematical equations. An equation file is compiled to create a waveform file and to output the waveform.

Sequence Editor

This editor is used to create and edit sequence files. Sequence files assemble a number of waveforms or sequence files in order.

Autostep Editor

This editor is used to create and edit autostep files. Autostep files are created by programming waveforms or sequence files. Each time a step signal is received, the waveform moves on to the next step in this program. The waveform is output by trigger. Since the output parameters set for each waveform or sequence file are part of the autostep file, the output parameters can change for each waveform.

Initial Menu

To create or edit waveform files, press the **EDIT** button in the **MENU** column to display the initial menu. Figure 4A-1 shows the structure of the initial **EDIT** menu.

Initial Menu Structure

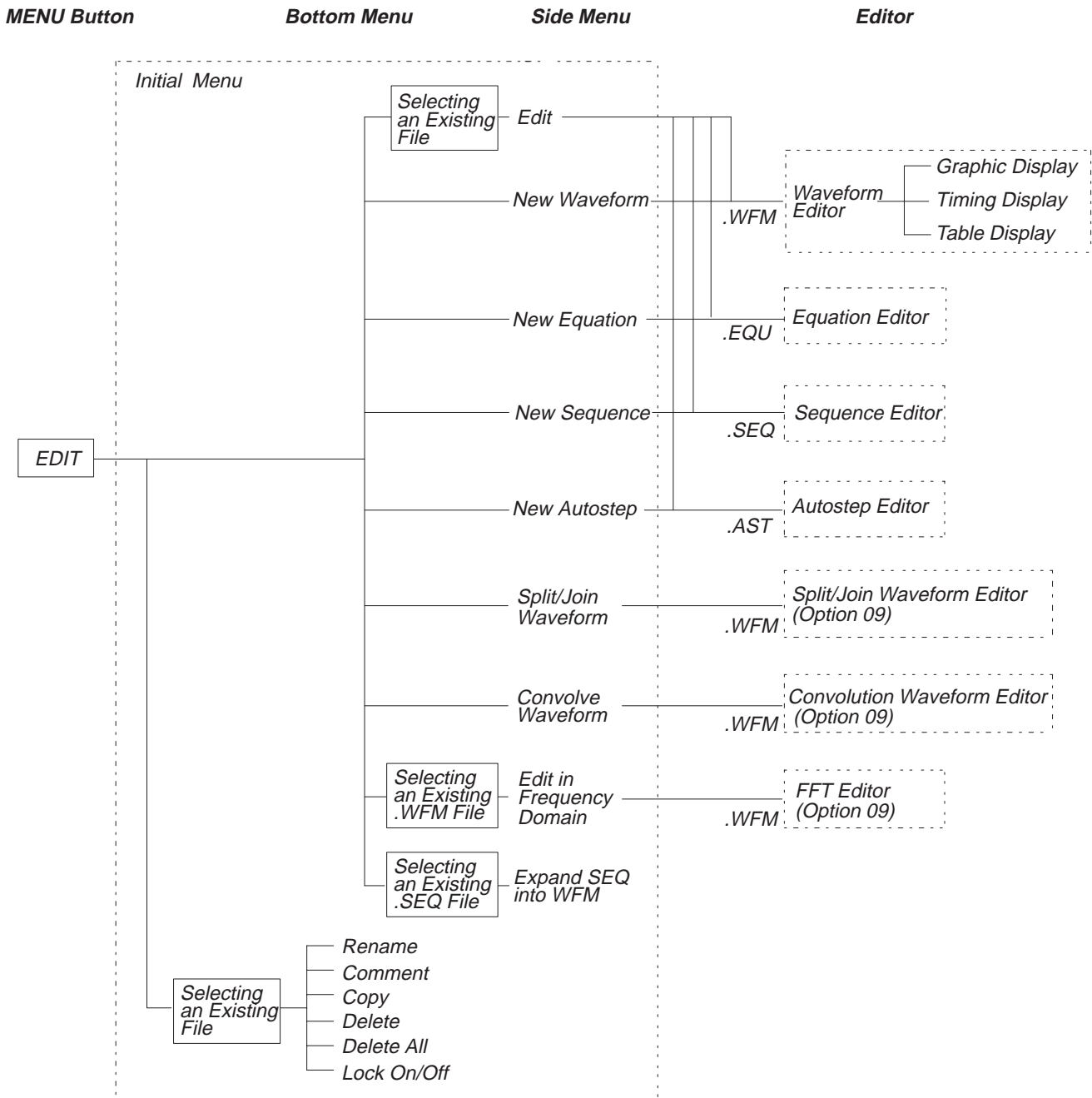

Figure 4A-1: Initial EDIT Menu Structure

Menu Functions

The following list shows the functions available for each menu item and the page on which you can find a description of that function.

Table 4A-1: Menu Functions

Menu	Function	Page
Edit	Editing an existing file	4A-7
New Waveform	Creating a new file (.WFM) Waveform editor Graphic display Timing display Table display	4A-7 4A-15 4A-27 , 4A-32 , 4A-44 4A-32 , 4A-100 4A-32 , 4A-133
New Equation	Creating a new file (.EQU) Equation editor	4A-7 4A-141
New Sequence	Creating a new file (.SEQ) Sequence editor	4A-7 4A-165
New Autostep	Creating a new file (.AST) Autostep editor	4A-7 4A-176
Split/join Waveform	Split/join waveform editor (Option 09)	4A-192
Expand SEQ into WFM	Expanding a sequence file into a waveform file	4A-12
Convolve Waveform	Convolution waveform editor (Option 09)	4A-202
Edit in Frequency Domain	FFT editor (Option 09)	4A-208
Rename	Renaming a file	4A-8
Comment	Comment input	4A-9
Copy	Copying a file	4A-9
Delete	Deleting a file	4A-9
Delete All	Deleting a file	4A-9
Lock On/Off	Locking and unlocking files	4A-11

CRT Display

Figure 4A-2 shows the initial menu of the **EDIT** . A description for each callout follows.

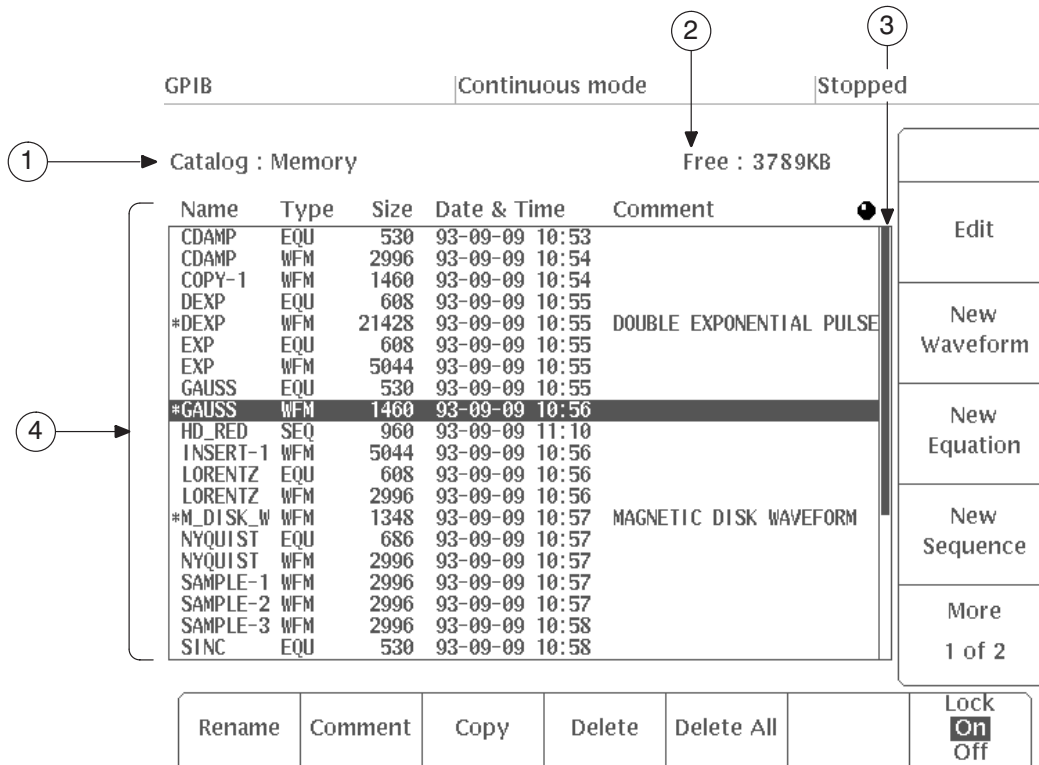

Figure 4A-2: Display of the Initial Menu

(1) Catalog:Memory

The display list shows the files in internal memory.

(2) Free Memory

Available internal memory is indicated.

(3) Scroll Indicator

The file area of memory displayed on the screen is indicated by an inverted display area in the scroll indicator. Up to 20 files can be displayed on the screen. To display more files, scroll the screen up or down by turning the general purpose knob.

(4) File List

This list displays the files in the internal memory of the instrument. The display gives the following information about the file: **Name**, **Type**, **Size**, **Date & Time** and **Comment**. Select a file by turning the general purpose knob. The selected file will appear inverted on the display.

Name — Files saved in internal memory are displayed in this column.

Type — Name extensions of each file are displayed in this column. Name extensions are **.WFM**, **.EQU**, **.SEQ**, and **.AST**. The file is identified by its name extension for each editor.

Size — The memory occupied by each file is indicated in bytes.

Date & Time — The date and time the file was saved in the internal memory is displayed in this column.

Comment — Any comment defined for the file is displayed.

Creating or Editing a File

Select one of the items from the side menus in the initial menu to create a new file (**New Waveform**, **New Equation**, **New Sequence**, or **New Autostep**) or to edit an existing file (**Edit**).

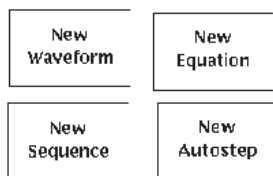

Creating a New File

When a **New** command (**New Waveform**, **New Equation**, **New Sequence** or **New Autostep**) is selected, a new file will be created by the appropriate editor.

Procedure

- Step 1:** Press the **EDIT** button in the **MENU** column to display the initial menu.
- Step 2:** Select one of the following editors in the side menu, depending on what type of file you wish to create.
 - **New Waveform** Waveform editor
 - **New Equation** Equation editor
 - **New Sequence** Sequence editor
 - **New Autostep** Autostep editor

To select the autostep editor, select **More** from the side menu in the initial menu and then select **Autostep Editor** from the second page of the side menu.

- Step 3:** Select an editor and create the file. The file name in the upper left of the screen has not yet been assigned, so it is *****.extension.

Editing an Existing File

To edit an existing file, select **Edit** and perform the following steps:

Procedure

- Step 1:** Press the **EDIT** button in the **MENU** column to display the initial menu.
- Step 2:** Turn the general purpose knob to select a file from the internal memory file list displayed in the initial menu.
- Step 3:** Select **Edit** from the side menu. The system automatically enters the editor appropriate for the file-type extension so the selected file can be edited.



Using File Editing Functions

The following operations can be performed for the file that has been created:

- **Rename** Renaming a file
- **Comment** Comment input
- **Copy** Copying a file
- **Delete** Deleting a file

NOTE. When the file is locked (indicated by an asterisk displayed in front of the file name), it is not possible to change the file name, enter a comment or delete the file. See "Locking and Unlocking Files" in this section.

Renaming a File

The **Rename** item is used to change a file name.

Procedure

- Step 1:** Use the general purpose knob to select the file to be renamed from the initial menu file list.
- Step 2:** Select **Rename** from the bottom menu. The menu for changing the file name is displayed. See Figure 4A-3.

Rename

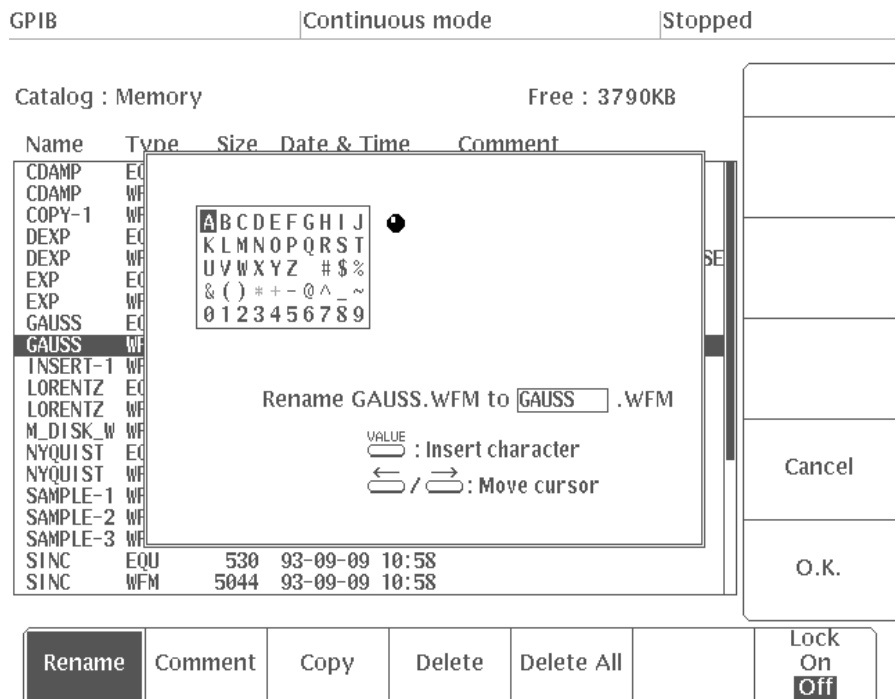

Figure 4A-3: Menu Displayed When Rename is Selected

Before entering the new file name, you must delete the current file name.

- Step 3:** To delete a character, press the Delete button on the front panel. This deletes the character right before the cursor. The cursor can be moved with the front panel ← and → buttons.

Now, input the new file name.

- Step 4:** Use the general purpose knob to select a character.
- Step 5:** Press the front panel **VALUE** button. The selected character is inserted immediately before the cursor blinking in the file name input column.
- Step 6:** Repeat Steps 4 and 5 until the entire name has been entered. Up to 8 characters can be input.

NOTE. The following cannot be used as file names: **CLOCK, CON, AUX, COM1, COM2, LPT1, LPT2, LPT3, NUL, and PRN**. Also, the " ", "*", and "+" characters in the character menu can not be used in file names and cannot be selected.

- Step 7:** To enter the file name, select **O.K.** To cancel that file name, select **Cancel**.

When **O.K.** is selected, the file is saved into internal memory with the changed file name and displayed in the file list on the CRT screen. Select **O.K.** or **Cancel** to return to the initial menu.

NOTE. If there is already a waveform file in internal memory with the name the compiled waveform file will be given, a message is displayed asking if you are sure you want to overwrite the old file. Overwriting erases the data in the old file.

Comment Input

Comment

Select **Comment** to input a comment. The input method for the comment is the same as that for **Rename** above. The comment may be up to 24 characters long. All the characters in the character menu can be used.

Copying a File

Copy

Select **Copy** to display a menu for inputting the copy destination file name. The input method for the file name is the same as that for **Rename** above.

Deleting a File

EDIT Menu



Select **Delete** or **Delete All** to delete unnecessary files. **Delete** deletes files in internal memory one at a time; **Delete All** deletes all the files in internal memory.

Procedure

- Step 1:** Use the general purpose knob to select the file to be deleted from the file list in the initial menu.
- Step 2:** Select **Delete** from the bottom menu. This instrument asks you if you are sure you want to delete the selected file. See Figure 4A-4.

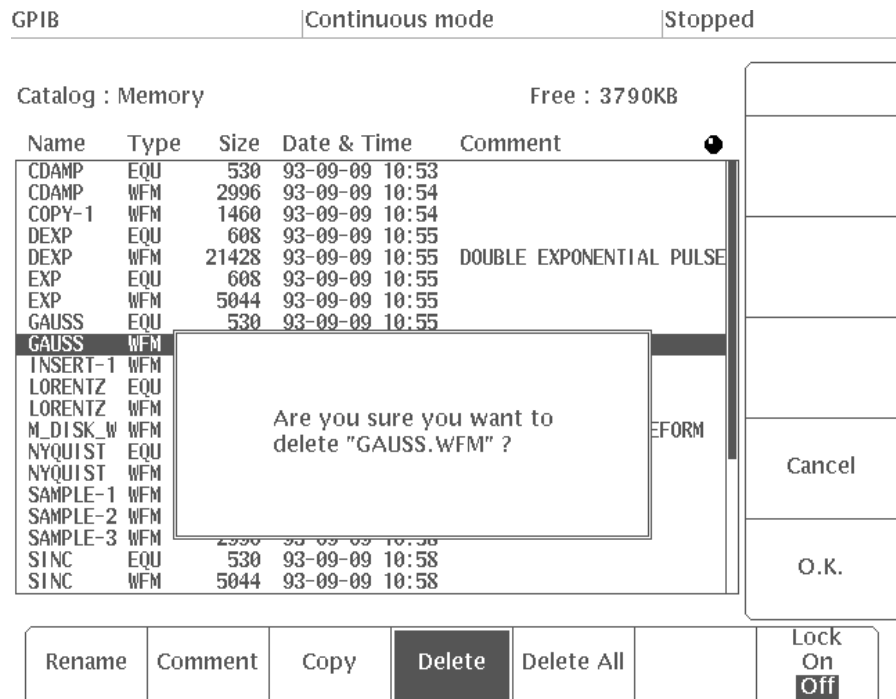

Figure 4A-4: Menu Displayed When Delete is Selected

If you select **O.K.** from the side menu, the file is deleted. If you decide not to delete the file, select **Cancel**. When either **O.K.** or **Cancel** is selected, the system returns to the initial menu.

Lock
On
Off

Locking and Unlocking Files

Select **Lock** to lock or unlock a file. When the file is locked, it is not possible to delete the file or change the file name or the comments for that file.

NOTE. While a locked file can have its output parameters changed with the **SETUP** menu, the original output parameters are retained. Thus, when the locked file is loaded again into waveform memory, the original parameters are set again.

Procedure

- Step 1:** Use the general purpose knob to select the file to be locked from the file list in the initial menu.
- Step 2:** Press the **Lock** bottom menu button. The selected file is locked and **On** is selected for the **Lock** label. Locked files have "*" next to their names in the display. See Figure 4A-5.

GPIB		Continuous mode		Stopped	
Catalog : Memory				Free : 3789KB	
Name	Type	Size	Date & Time	Comment	
CDAMP	EQU	530	93-09-09 10:53		Edit
CDAMP	WFM	2996	93-09-09 10:54		
COPY-1	WFM	1460	93-09-09 10:54		
DEXP	EQU	608	93-09-09 10:55		New Waveform
*DEXP	WFM	21428	93-09-09 10:55	DOUBLE EXPONENTIAL PULSE	
EXP	EQU	608	93-09-09 10:55		
EXP	WFM	5044	93-09-09 10:55		
GAUSS	EQU	530	93-09-09 10:55		
*GAUSS	WFM	1460	93-09-09 10:56		New Equation
HD_RED	SEQ	960	93-09-09 11:10		
INSERT-1	WFM	5044	93-09-09 10:56		
LORENTZ	EQU	608	93-09-09 10:56		
LORENTZ	WFM	2996	93-09-09 10:56		
*M_DISK_W	WFM	1348	93-09-09 10:57	MAGNETIC DISK WAVEFORM	New Sequence
NYQUIST	EQU	686	93-09-09 10:57		
NYQUIST	WFM	2996	93-09-09 10:57		
SAMPLE-1	WFM	2996	93-09-09 10:57		
SAMPLE-2	WFM	2996	93-09-09 10:57		
SAMPLE-3	WFM	2996	93-09-09 10:58		
SINC	EQU	530	93-09-09 10:58		More
					1 of 2
Rename	Comment	Copy	Delete	Delete All	Lock On Off

Figure 4A-5: Menu Displayed When Lock is Selected

- Step 3:** Select **Delete** from the bottom menu. Check to make sure that the words **"File locked."** is displayed in the message area to indicate that it is not possible to delete the file.

Expand SEQ
Into WFM

- Step 4:** If you press the **Lock** bottom menu button again, the file is unlocked and **Off** in the **Lock** label is displayed inverted. Files on a floppy disk or in NVRam can be locked/unlocked in the same manner with the **UTILITY** menu.

Expanding a Sequence File into a Waveform File

The "Expand SEQ into WFM" item is displayed when a sequence file has been selected from the file list in the initial menu. It is used to expand a waveform created from a sequence file (.SEQ) into a waveform file (.WFM).

Procedure

- Step 1:** Select **More** from the side menu in the initial menu to display the second page of the side menu.
- Step 2:** Using the general purpose knob, select a sequence file (the file name should end in .SEQ) from the file list in the initial menu. The "Expand SEQ into WFM" item will appear in the side menu.
- Step 3:** Select **Expand SEQ into WFM** from the side menu. You will be asked to provide a name for the resulting waveform file. See Figure 4A-6. If necessary, change the default name. See "Renaming a File" described above.

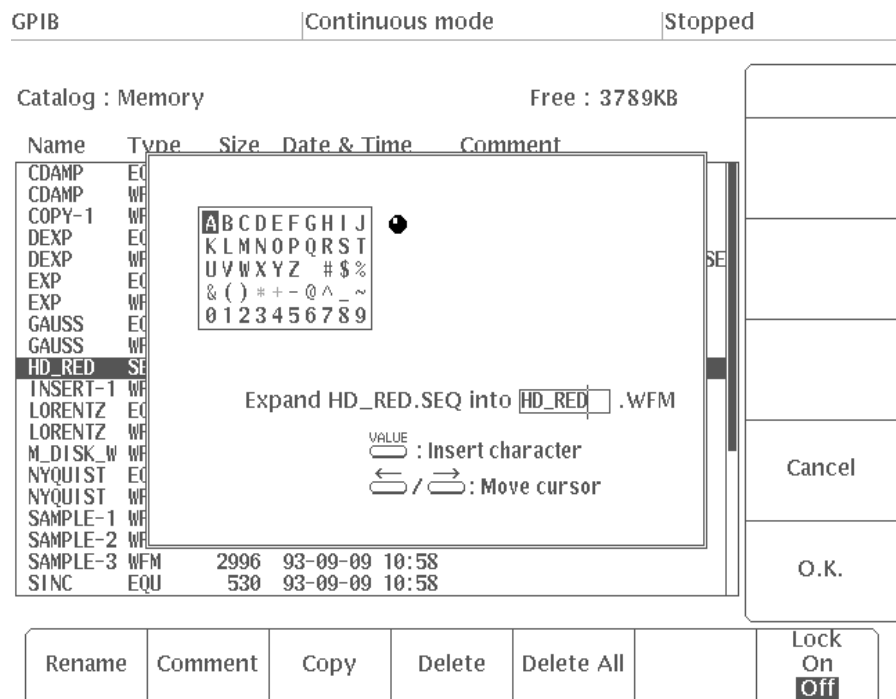

Figure 4A-6: Menu Displayed When Expand SEQ into WFM is Selected

- Step 4:** Press **O.K.** to confirm the file name. Press **Cancel** to cancel the operation.

If a file already exists with the same name as that designated in Step 3, selecting **O.K.** will cause a message to appear asking you to confirm that you really want to overwrite the existing file. Select **O.K.** again to overwrite the existing file; select **Cancel** to leave the existing file intact.

Before the sequence file is expanded into a waveform file, the following message will appear, asking you to confirm that you want to delete the source file.

Delete the sequence and all the component files?

- Step 5:** Select **O.K.** to delete the source file during expansion. Select **No** to preserve the source file. Select **Cancel** to cancel the expansion process.

No — The source file will be left as is and the sequence file will be expanded into a waveform file, at which point the initial menu will reappear. The expanded waveform file will be added to the file list in the initial menu. An error in the expansion process will destroy that waveform file.

O.K. — The source sequence file and all component files will be deleted and the sequence file will be expanded into a waveform file, at which point the initial menu will reappear. The expanded waveform file will be added to the file list in the initial menu. An error in the expansion process will destroy that waveform file.

Cancel — The expansion process will be canceled and the initial menu will reappear.

Waveform Editor

Use the waveform editor to create or edit waveform files with the extension of **.WFM**. Waveform files contain waveform data, marker signal data, and the waveform output parameters set with the **SETUP** menu. The waveform data display formats are graphic, table, and timing. The editing functions displayed depend on the data display format.

In the waveform editor, 0 to 254 in 8-bit resolution on the vertical axis is expressed as -1.0000 to $+1.0000$ (with 255 as 1.0079). At this level, there is no relationship to the **Amplitude/Offset** setting in the **SETUP** menu used when the waveform is output.



Entering the Waveform Editor

Procedure

- Step 1:** Press **EDIT** in the **MENU** column. The initial **EDIT** menu will appear.
- Step 2:** Select **Edit** or **New Waveform** from the side menu.
 - **Edit** Use this command to select and edit an existing waveform file (**.WFM**)
 - **New Waveform** Use this command to create a new waveform file

As a result of the procedure described above, the waveform editor will appear on the screen. The waveform editor can be displayed in one of three formats: graphic, timing or table; the default setting is graphic display. Figure 4A-7 shows an example in which an existing waveform file has been selected.

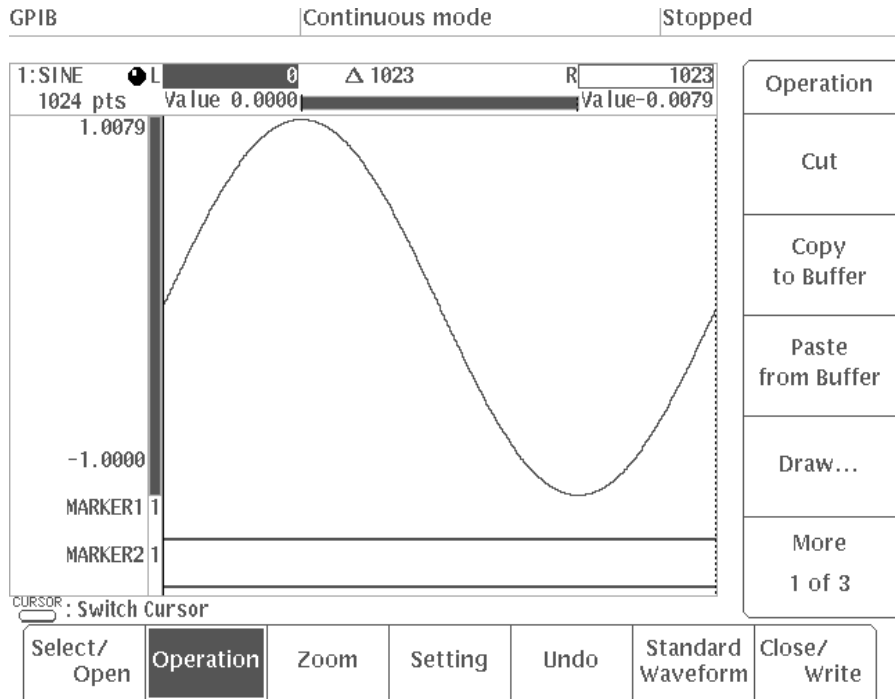

Figure 4A-7: Graphic Display Screen

Opening and Selecting Editing Areas

Select/
Open

Up to three waveforms can be displayed and edited in the waveform editor at the same time. This makes it easy to edit several related waveforms. Figure 4A-8 shows an example in which three waveforms are displayed. In this example, the box around the **Waveform2** area shows that this waveform is selected and is currently being edited.

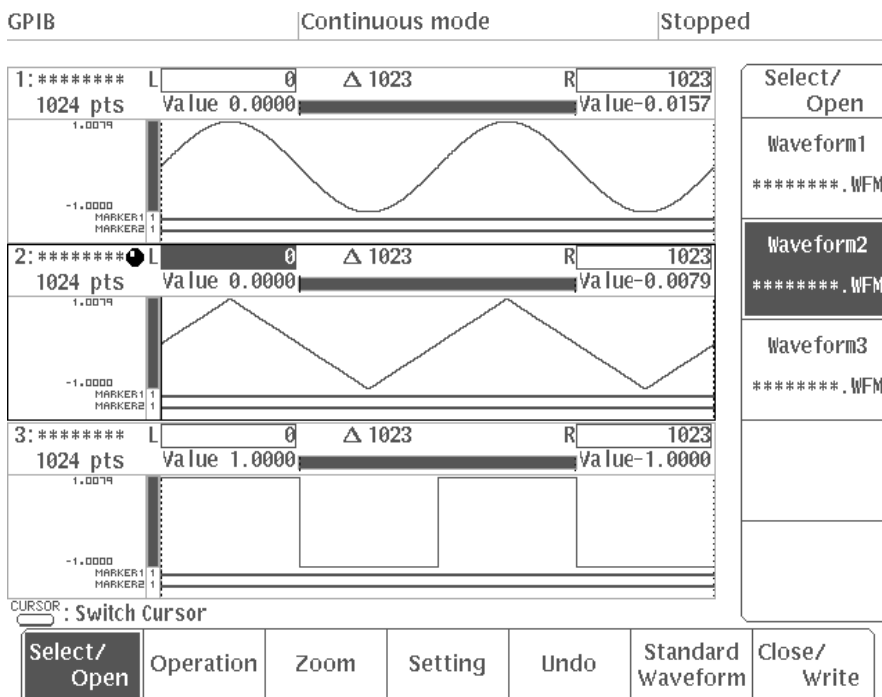

Figure 4A-8: Waveform Editor With Three Editing Areas

When there is more than one waveform displayed in the waveform editor, the following menu items will be added:

- **Cursor Link to...** will be added to the **Setting** menu item. See page 4A-36.

Cursor Link to... — Used to link the cursors in different editing areas.

- Three additional commands (**Multiple Copy...**, **Convolute...**, **Compare...**) will be added to the **Operation** menu item. See pages 4A-82, 4A-89, and 4A-92, respectively.

Multiple Copy... — Used to copy a waveform in one editing area that has been designated with the vertical bar cursors into another editing area (in the space designated with the vertical bar cursors in that area), using the interval specified with **Interval**.

Convolute... — Used to perform convolution operations for the waveform in one area (in the space designated with the vertical bar cursors) with the part of a waveform in another editing area designated by the vertical bar cursors in that area.

Compare... — Used to compare the waveform in the area designated by the vertical bar cursors with the waveform in another editing area.

Procedure

In this example, you will select three waveforms in the waveform editor. The following procedure starts in the initial **EDIT** menu.

- Step 1:** Select **New Waveform** from the side menu. The editing area 1 is displayed for creating a new waveform.
- Step 2:** Press **Select/Open** from the bottom menu. In the side menu, "Waveform1" refers to the waveform file in editing area 1.
- Step 3:** Select **Another Waveform** from the side menu. A file list will appear, allowing you to select the waveform file to be displayed in editing area 2.

The top item in the list (**New Waveform**) is used to create a new waveform file. The subsequent items are the names of existing waveform files. See Figure 4A-9.

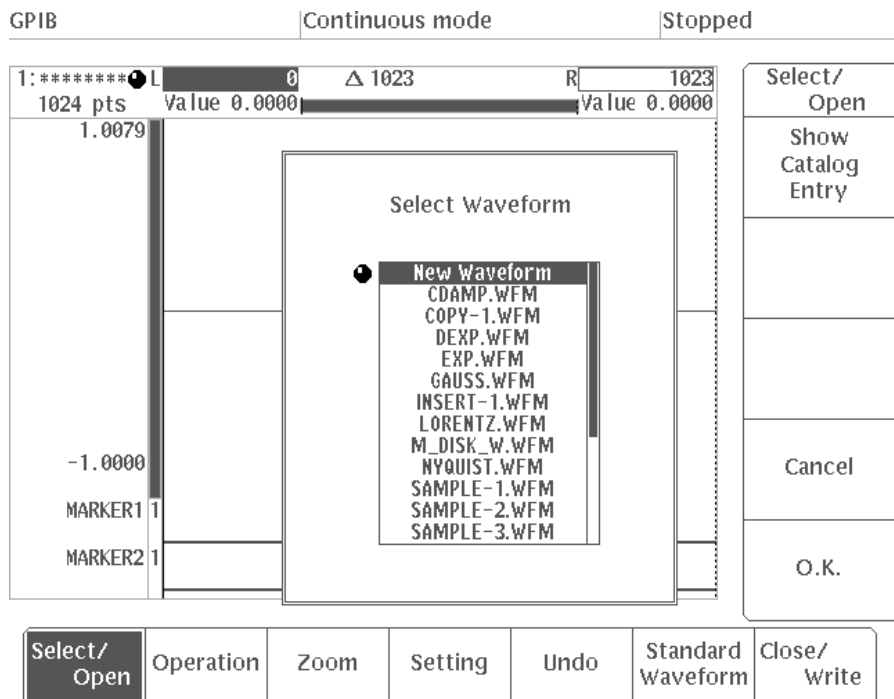

Figure 4A-9: Menu Display When “Another Waveform” is Selected

- Step 4:** Using the general purpose knob, select **New Waveform**. The new waveform file created in this step will be assigned to editing area 2.
- Step 5:** Select **O.K.** from the sub-menu. When this is done, **Waveform2** will be added to the side menu and the **Waveform2** editing area will appear on the screen. See Figure 4A-10.

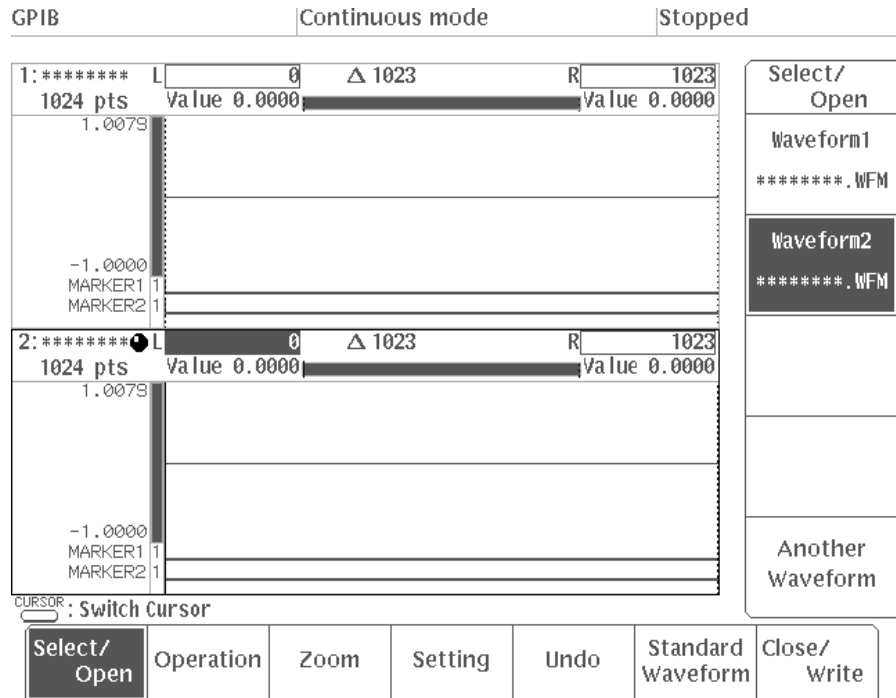

Figure 4A-10: Waveform2 Added

- Step 6:** Select **Another Waveform** from the side menu.
- Step 7:** Using the general purpose knob, select a waveform file. In this example, we will select an existing waveform file.
- Step 8:** Select **Show Catalog Entry** from the sub-menu. This allows you to check the waveform for the selected file on the screen. See Figure 4A-11.

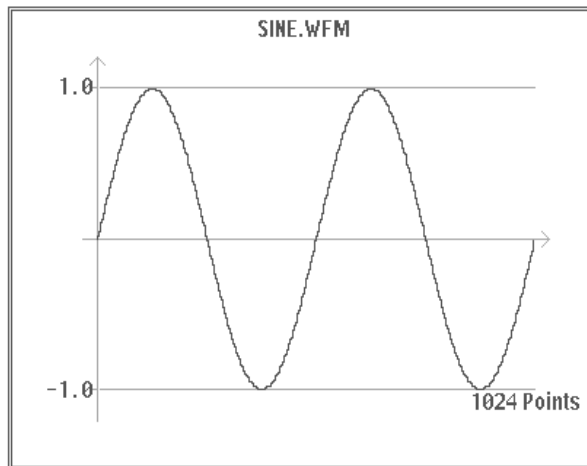

Figure 4A-11: Menu Display When Show Catalog Entry is Selected

- Step 9:** Select **Continue** from the sub-menu.
- Step 10:** Select **O.K.** from the sub-menu. **Waveform3** will be added to the side menu and the **Waveform3** editing area will appear on the screen. See Figure 4A-12.

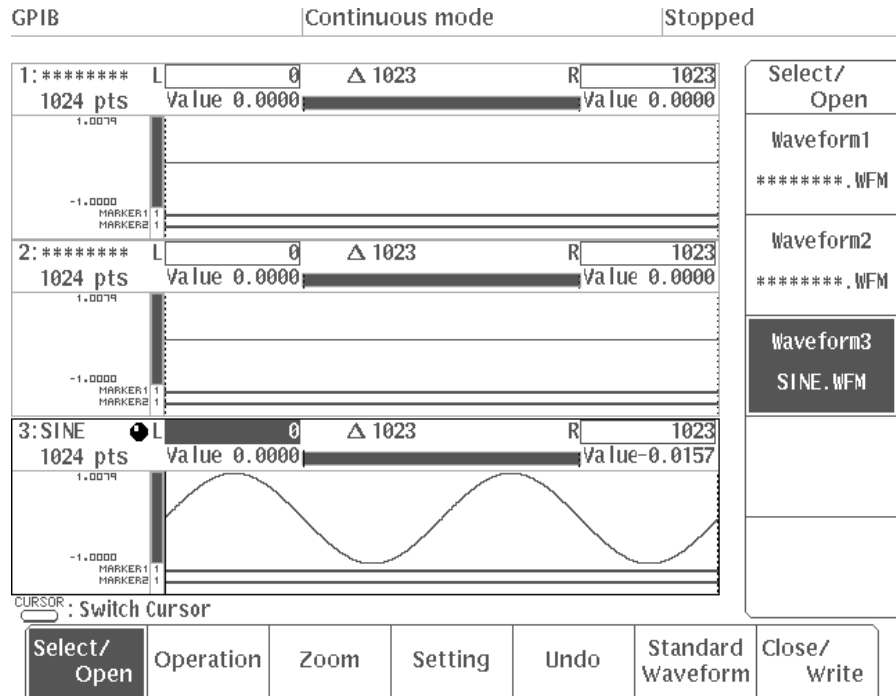

Figure 4A-12: Waveform3 Added

The three waveform items (**Waveform1**, **Waveform2** and **Waveform3**) will be displayed in the side menu. You will select the waveform to be edited from among these items.

- Step 11:** Select **Waveform2** from the side menu. A box will appear around the editing area to indicate that this waveform has been selected.

To close a waveform, select that **Waveform** (editing area) from the side menu and then select **Close/Write** from the bottom menu. See "Saving Files and Exiting the Editor" in this section.

Close/ Write

Saving Files and Exiting the Editor

When you select **Close/Write** from the bottom menu, the newly created or edited file currently selected in the side menu will be saved to the instrument's internal memory and the waveform editor will disappear.

NOTE. *The procedure for saving files and exiting the editor is the same for all editors. The only difference is that the **Close/Write** item in the waveform editor changes to **Exit/Write** in the other editors; it functions in the same manner. (The word "**Close**" is used in the waveform editor because more than one waveform can be opened in this editor.)*

Choices When Exiting the Editor

Select **Close/Write** from the bottom menu to display a side menu containing **Write and Close**, **Close without Writing**, and **Write** menu items. These functions are explained next.

- **Write and Close**

When a new file is created, if you select **Write and Close**, a menu for naming the file is displayed. Input the file name, then select **O.K.** from the sub-menu. The file is saved into internal memory with that name and the system returns to the initial menu. If **Cancel** is selected, the input file name is canceled and the system returns to the editor.

When you exit the editor after editing an existing file and you select **Write and Close**, the menu for naming the file is not displayed. Instead, the system immediately returns to the initial menu and the file created is saved with the existing file name in internal memory.

- **Close without Writing**

When this item is selected, the system returns to the initial menu without saving the created or edited file to internal memory. In this case, a message asking you if it is ok to erase the created data is displayed on the CRT screen. Reply **O.K.** or **Cancel**.

- **Write**

When **Write** is selected, the file name menu is displayed. If you input or change the file name, then select the sub-menu **O.K.** item, the created or edited waveform data is saved into internal memory with that file name and the system returns to the editor it has been in. If the file name is changed, the old file is left as is and a new file is created with the new file name. If you select **Cancel**, the input file name is canceled and the system returns to the editor without saving the data into internal memory. Although the created or edited data is not saved at this time, it is retained for further editing.

Naming a File

When saving a newly created file, a file name must be created. The menu for creating a file name is the same for all the editors.

Procedure

- Step 1:** Select **Close/Write** from the bottom menu.
- Step 2:** Select **Write and Close** from the side menu. Figure 4A-13 shows the menu for inputting a file name.

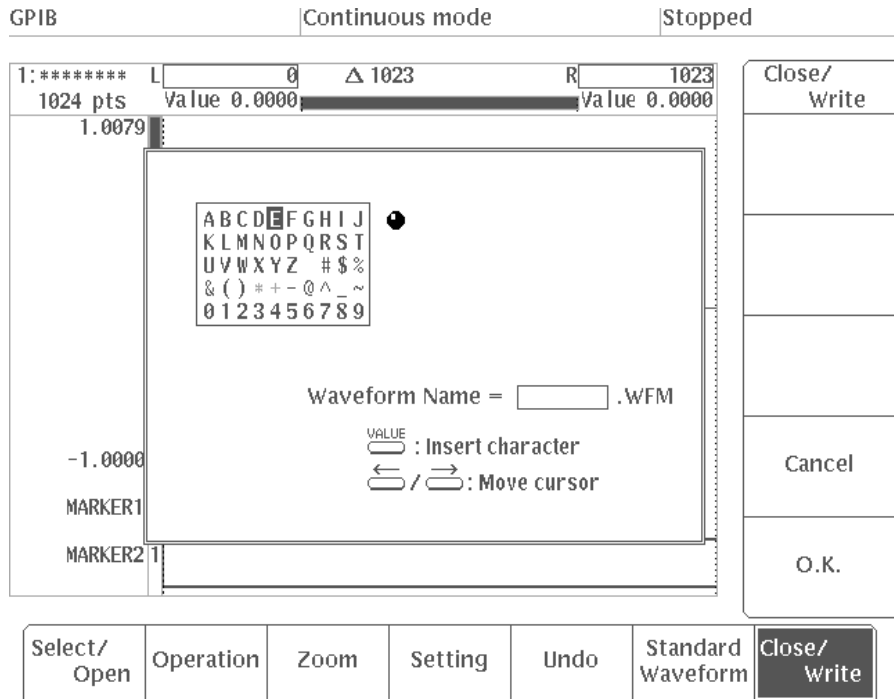

Figure 4A-13: Menu for Inputting a File Name

NOTE. When no editing has been performed in the editor, selecting the **Write and Close** item will not cause the menu used to enter the file name to appear; the initial menu will reappear instead.

Now, input the file name.

- Step 3:** Use the general purpose knob to select a character.



- Step 4:** Press the front panel **VALUE** button. The selected character is inserted immediately before the cursor.

Waveform Name = \$.WFM

- Step 5:** Repeat Steps 3 and 4 until the entire file name has been entered. In this example, we will enter the name **SAMPLE**.

Waveform Name = .WFM

Up to 8 characters can be input. To delete a character, press the Delete key on the front panel. This deletes the character right before the cursor. The cursor can be moved with the front panel ← and → buttons.

NOTE. The following can not be used as file names: **CLOCK, CON, AUX, COM1, COM2, LPT1, LPT2, LPT3, NUL, and PRN**. Also, the " " (space) and "*" and "+" characters in the character menu can not be used in file names and can not be selected.

- Step 6:** To enter the file name, select **O.K.** To cancel that file name, select **Cancel** from the side menu.

When the Waveform Size is a Multiple of 32

When **O.K.** is selected, the file will be saved to the internal memory under the file name that has been entered and the initial menu will reappear. The new file name will be displayed in the file list in the initial menu. If **Cancel** is selected, the name that has been entered will be disregarded and the editor screen will reappear.

NOTE. If there is already a waveform file in internal memory with the name the compiled waveform file will be given, a message is displayed asking if you are sure you want to overwrite the old file. Overwriting erases the data in the old file.

When the Waveform Size is Not a Multiple of 32

At the waveform output stage, the number of points in the waveform file is changed into a multiple of 32 and then the file is loaded into waveform memory. As a result, when a waveform whose size is not a multiple of 32 has been created with the editor, when saving the file you select from the menu what to do about the fraction.

When **O.K.** is selected in Step 6, the following menu will appear:

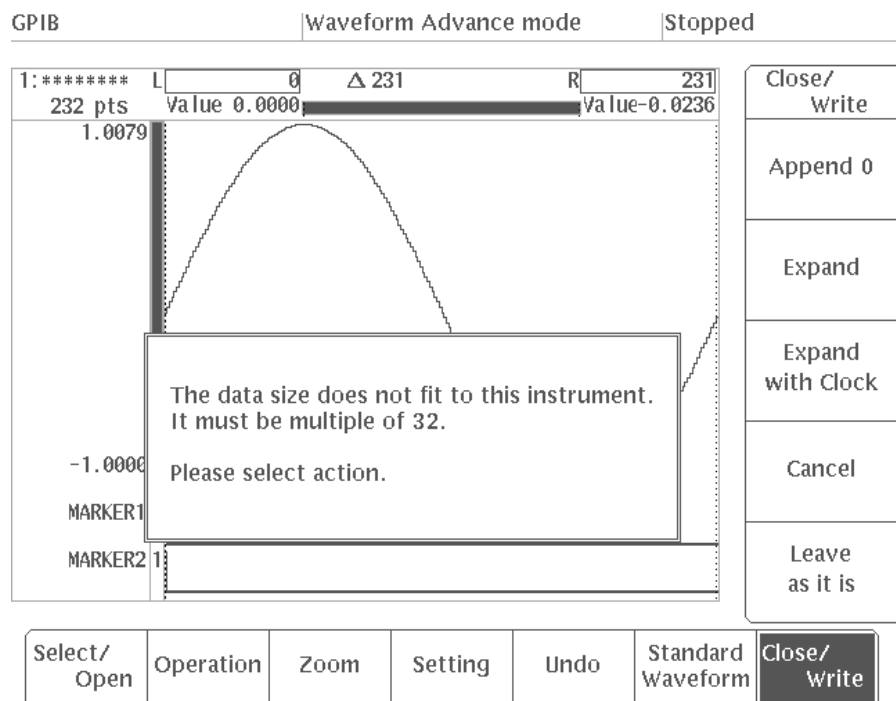

Figure 4A-14: Fraction Processing Menu

- Step 7:** Select the fraction processing method from the side menu. As soon as the method is selected, the file will be saved to internal memory under the file name that you have entered, and the initial menu will reappear. If you select **Cancel**, the entered file name will become invalid and the previous editor will reappear.

Any one of the following four processes can be selected:

Append 0 — Data at the 0 level will be added to the end of the waveform data to create a waveform file whose size is a multiple of 32.

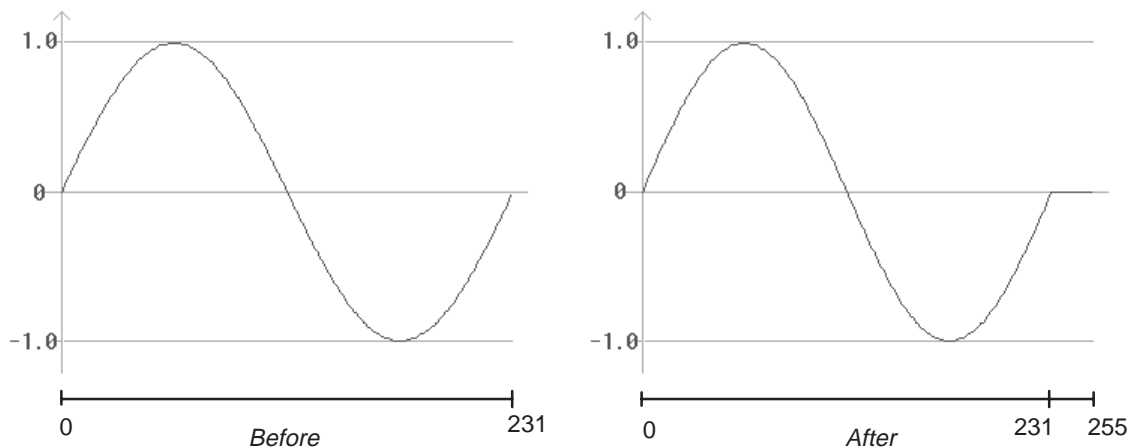

Figure 4A-15: Fraction Processing

Expand — The waveform data will be expanded to create a waveform file whose size is a multiple of 32.

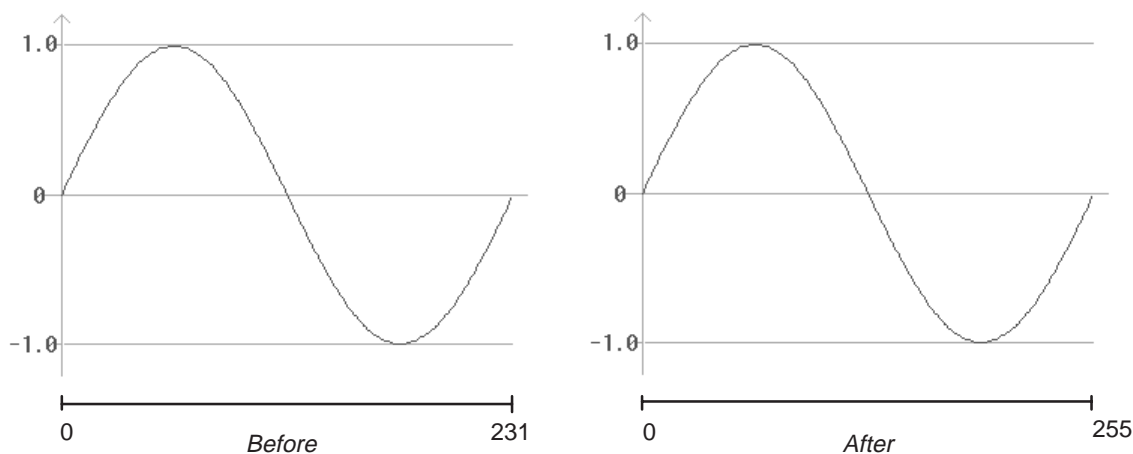

Figure 4A-16: Fraction Processing

Expand with Clock — The waveform data will be expanded to create a waveform file whose size is a multiple of 32. At the same time, the clock frequency will be increased to the same extent and saved to the file.

Leave as it is — The file will be created without changing the waveform size.

NOTE. *In the hardware sequencer off state, when a waveform whose size is not a multiple of 32 is output, data at the 0 point is added to the end of the waveform to make the waveform size a multiple of 32, after which it is loaded to waveform memory. For details, see "Selecting a Waveform or Sequence File" in Section 4B "SETUP Menu."*

*In the hardware sequencer on state, when a sequence file is loaded to waveform memory with **Waveform Advance** in the **MODE** menu selected, waveforms are loaded into memory contiguously. Each waveform will have at least 640 points and have a length that is a multiple of 32 points.*

Graphic Display

In graphic display, waveforms are created and edited being displayed in graphic form. The horizontal axis indicates time or number of points, while the vertical axis indicates the levels. Waveforms are displayed at each data point in 8-bit resolution. On the left beneath the waveform is an indicator showing whether the marker signal is high or low. All editing operations are performed between the two vertical bar cursors.

Graphic Display Menu Structure

Figure 4A-17 is a diagram showing the menu structure in graphic display. This is not a complete list; for a complete list, see the diagram at the beginning of the section on each menu. An ellipsis (...) next to an item in the side menu indicates that there is a sub-menu below that item listing additional choices. Commands in the sub-menu are executed with the **Execute** command; when **Go Back** is selected, the sub-menu disappears and the side menu reappears.

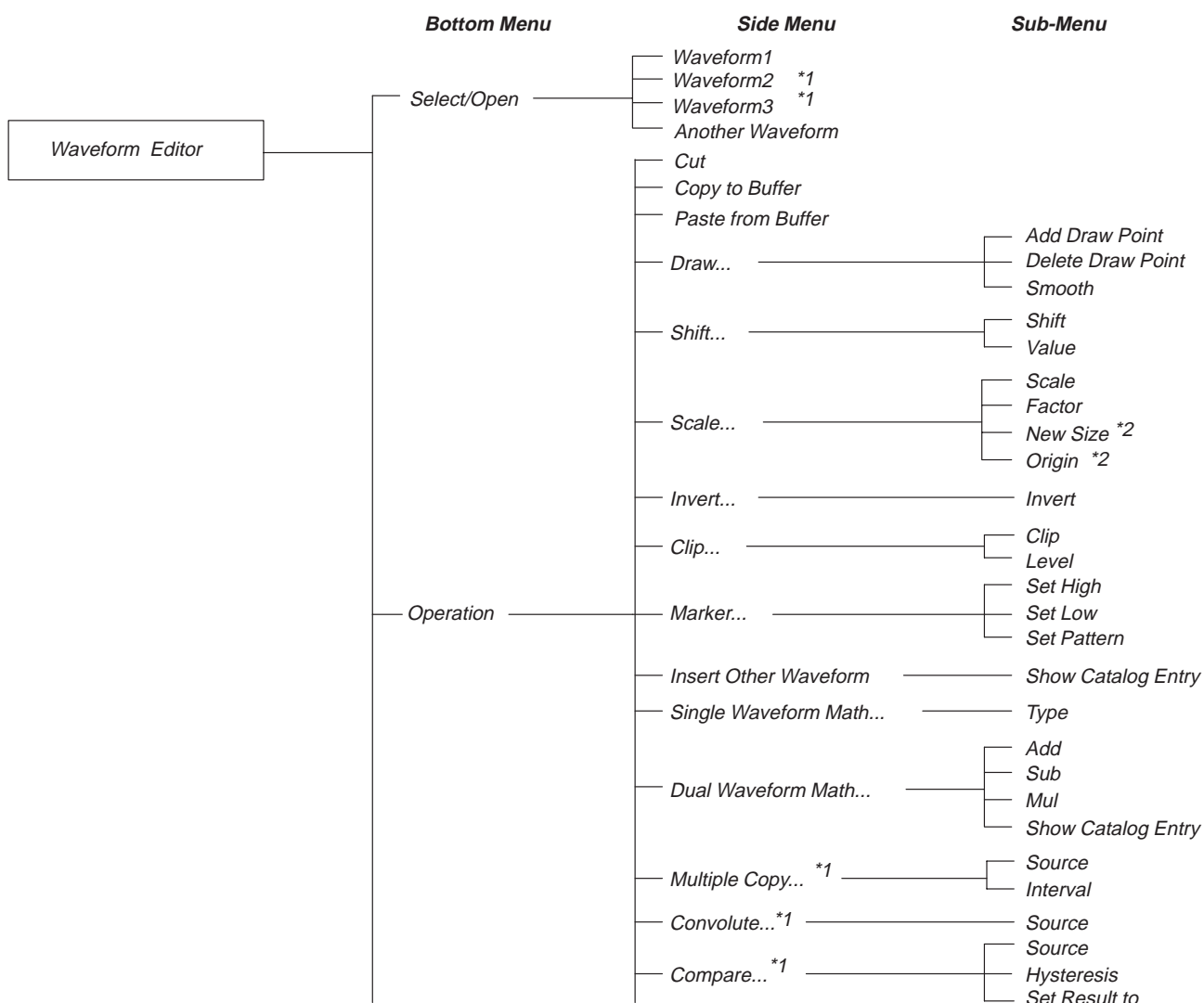

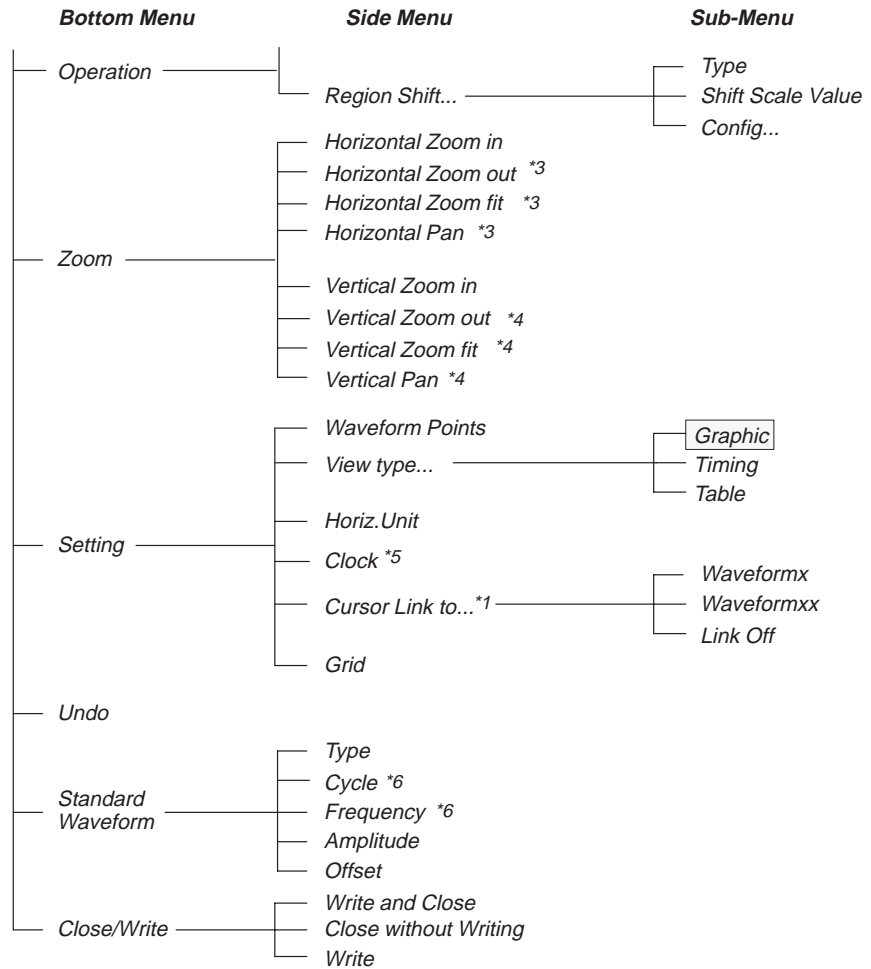

Figure 4A-17: Waveform Editor Graphic Display Menu Structure

- *1 This item appears when another editing area has been created by selecting **Another Waveform** item under Select/Open in the bottom menu.
- *2 If Horizontal is selected for **Scale** in the sub-menu, **New Size** appears; if **Vertical** is selected, **Origin** appears.
- *3 This item appears when the waveform on the screen has been zoomed in the horizontal direction by selecting the **Horizontal Zoom in** item under **Zoom** in the bottom menu.
- *4 This item appears when the waveform on the screen has been zoomed in the vertical direction by selecting the **Vertical Zoom in** item under **Zoom** in the bottom menu.
- *5 This item appears when **Time** has been selected for **Horiz. Unit** in the side menu.
- *6 If **Point** is selected for **Horiz. Unit** under **Setting** in the bottom menu, **Cycle** appears; if **Time** is selected for this item, **Frequency** appears.

Menu Functions

The following list describes the functions for each of the menu items and gives the number of the page on which you can find a more detailed explanation of that item.

Table 4A-2: Menu Functions

Menu	Function	Page
Select /Open	Opening and selecting editing areas	4A-16
Operation	Editing waveforms in graphic display	4A-44
Cut	Cutting waveforms	4A-45
Copy to Buffer	Copying waveforms	4A-46
Paste from Buffer	Pasting waveforms	4A-46
Draw...	Draw function	4A-48
Shift...	Shift function	4A-51
Scale...	Scaling function	4A-53
Invert...	Invert function	4A-57
Clip...	Clip function	4A-59
Marker...	Setting a marker	4A-60
Insert Other Waveform	Inserting other waveforms	4A-63
Single Waveform Math	Single waveform calculations	4A-66
Dual Waveform Math...	Calculations with other waveform data	4A-71
Region Shift...	Specified region shift function	4A-74
Multiple Copy...	Multiple copy	4A-82
Convolute...	Convolution calculations	4A-89
Compare...	Comparing waveforms	4A-92
Zoom	Zooming waveforms	4A-97
Setting	Settings for the waveform to be edited	4A-32
View type...	Selecting the waveform data display format	4A-32
Waveform Points	Setting waveform point count	4A-33
Horiz. Unit	Setting horizontal axis units	4A-34
Clock	Setting clock frequency	4A-35
Cursor Link to...	Linking the vertical bar cursors	4A-36
Grid	Displaying a grid in the editing area	4A-38
Undo	Undoing the previous operation	4-2
Standard Waveform	Creating a standard function waveform	4A-39
Close/Write	Saving files and exiting the editor	4A-21

Graphic Display Screen

The general graphic display is shown in Figure 4A-18. A description for each callout follows.

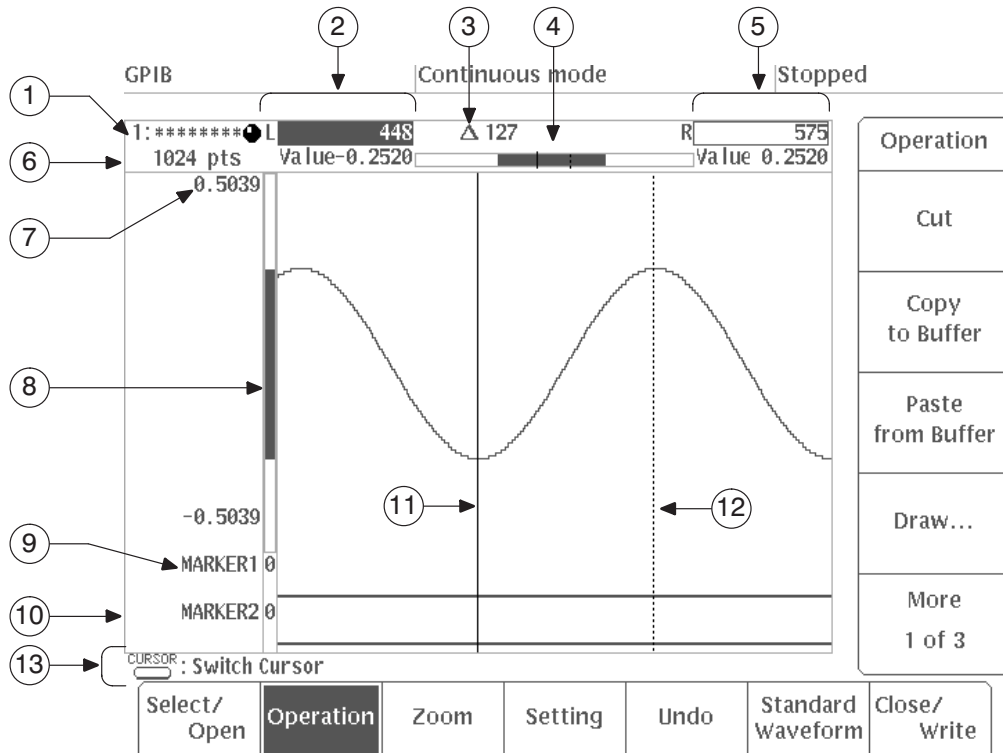

Figure 4A-18: Graphic Display Screen

(1) File Name

The name of the waveform file being edited. The number preceding the file name indicates the sequential number of that editing waveform. In this editor, up to three waveforms can be displayed and edited at the same time. If the name has not been set, ***** is displayed.

(2) L

Value

Shows the left vertical bar cursor position time or point value (**L**) and the vertical level (**Value**). When the cursor value is displayed inverted, this means the cursor value can be changed with the general purpose knob or numeric keys.

(3) Δ

Shows the time or point count between the left and right vertical bar cursors.

(4) Horizontal Scroll Indicator

When the display is magnified horizontally with **Zoom**, this indicator is displayed to show which waveform point positions are in the CRT display area. The area displayed on the CRT is shown with inverted display.

(5) R**Value**

Shows the right vertical bar cursor position time or point value (**R**) and the vertical level (**Value**).

(6) Number of Waveform Points

Shows the number of points in the waveform being edited.

(7) Top Waveform Level

Shows the top level for the waveform data displayed on the CRT.

(8) Vertical Scroll Indicator

When the display is magnified vertically with **Zoom**, this indicator is displayed to show where the CRT display area is in terms of the vertical axis full scale. The area displayed on the CRT is shown with inverted display.

(9) Bottom Waveform Level

Shows the bottom level for the waveform data displayed on the CRT.

(10) Marker

Shows the timing for the marker signal. The number to the right of the word "**MARKER**" indicates the state value for the marker at which the active vertical bar cursor (the one displayed with a solid line) locates.

(11) Left Vertical Bar Cursor

The active cursor is displayed with solid lines and the non-movable is displayed with broken lines. The left cursor indicates the left starting point for editing.

(12) Right Vertical Bar Cursor

Indicates the right end point for editing.

(13) Button Operations

This area shows how the front panel buttons operate in this menu.

 : **Switch Cursor**

Press the **CURSOR** button to toggle the active vertical bar cursor between left and right.

 : **Move Cursor**

The vertical bar cursor can be moved by pressing the **CURSOR** button.

Settings for the Waveform to be Edited

Setting

Before waveform data is created, you must use the **Setting** item in the side menu to select the environment for editing. The following settings are available:

- **View type...** Selecting the waveform data display format
- **Waveform Points** Setting waveform point count
- **Horiz. Unit** Setting horizontal axis units
- **Clock** Setting clock frequency
- **Cursor Link to...** Linking the vertical bar cursors
- **Grid** Displaying a grid in the editing area

NOTE. *These settings are the same in all display formats (graphic, timing and table).*

In the following section, each of these items will be discussed in detail.

Selecting the Waveform Data Display Format

View type...
Graphic

The **View type...** item allows you to set the display format for the waveform data. There are three choices: graphic, timing and table. The following diagram shows the menu configuration.

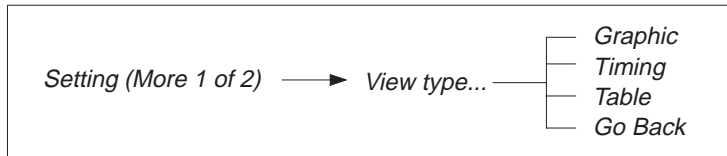

When you open the waveform editor, Graphic display is selected as the default option. If you want to change the display format, select **Setting** from the bottom menu and then **View type** from the side menu, then select the desired format (**Timing** or **Table**) from the sub-menu. Pressing the **Go Back** button cancels the operation and causes the side menu to reappear. See page 4A-91 for a discussion of timing display and page 4A-117 for a discussion of table display.

Waveform
Points

Setting Waveform Point Count

Waveform Points sets the number of points for waveform data. The following diagram shows the menu configuration.



Setting (More 1 of 2) → Waveform Points

The following formula is used to derive the number of points per period for the waveform to be created:

$$\text{No. of points} = \frac{\text{Clock frequency}}{\text{Frequency of output waveform}}$$

For example, for output of a 20 kHz sine wave, setting the clock frequency to 10.24 MHz will result in a waveform point value of 10.24 MHz/20 kHz = 512 points.

When creating a new waveform file, the point value is set to the default value of 1024. The waveform point value can be set to any value up to 262144. However, the waveform memory (the memory used to output the waveform) is 1M words (or 4M words when Option 01 is installed).

If the waveform point value is set longer than the current waveform data, new points with a value of zero are added at the right end of the waveform. On the other hand, if the waveform point value is set shorter than the current waveform data, points are deleted from the right end.

Procedure

To set the waveform point size to 512:

- Step 1:** Select **Setting** from the bottom menu.
- Step 2:** Select **Waveform Points** from the side menu.
- Step 3:** Use the numeric keys or the general purpose knob to enter a value of 512.

In the case of the numeric keys, press **5, 1, 2** and **ENTER** in that order.

Setting Horizontal Axis Units



Horiz. Unit sets the units for the horizontal axis for the displayed waveform in either time or number of points. The following diagram shows the menu configuration.

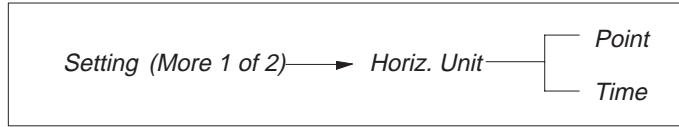

Each time the **Horiz. Unit** button in the side menu is pressed, the units toggle between **Time** and **Point**. When **Time** is selected, the **Clock** item is added to the side menu and the clock frequency can be set.

Time – Sets the horizontal axis unit to time. The cursor position data at the top of the CRT is displayed in time and data can be edited in time units.

Point – Sets the horizontal axis unit to points. The cursor position data at the top of the CRT is displayed in points and data can be edited in points.

In Figure 4A-19, the display on the left shows the horizontal axis unit set to **Point**, while the display on the right shows this value set to **Time**.

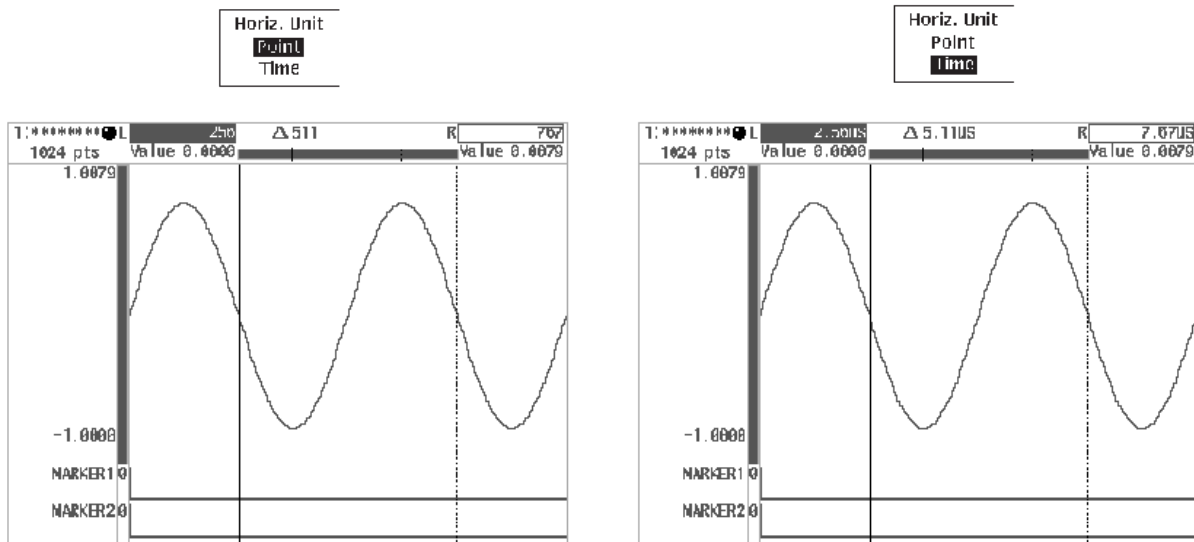

Figure 4A-19: Setting the Unit for the Horizontal Axis

When the horizontal axis unit is changed, even if you switch to table or timing display mode, the horizontal axis there is changed too.

Clock

Setting Clock Frequency

When the unit of the horizontal axis is time, the clock frequency can be set. The following diagram shows the menu configuration.

Setting (More 1 of 2) → Horiz. Unit (Time) → Clock

Select **Clock** from the side menu to set the clock frequency. This parameter determines the time between the data points (the inverse of the clock frequency). For example, when the maximum clock frequency on the AWG2041 is set to 1.024 GHz, waveform data can be edited at a resolution of 0.9765625 ns. Figure 4A-20 shows the setting menu for **Clock**.

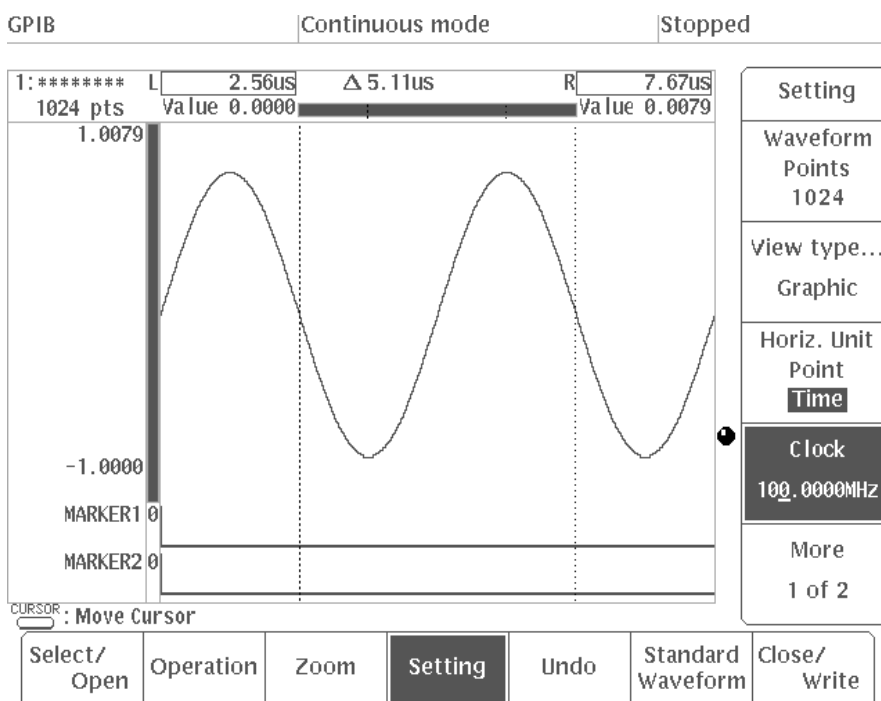

Figure 4A-20: Menu Display When Clock is Selected

Procedure

- Step 1:** Select **Setting** from the bottom menu.
- Step 2:** Press the **Horiz. Unit** key in the side menu to select **Time**.
- Step 3:** Select **Clock** from the side menu.
- Step 4:** Input the clock frequency with the numeric keys or the general purpose knob.

The default setting for clock frequency is 1.0 GHz. The clock frequency set in this process will be displayed in the **Internal Clock** item in the **SETUP** menu via the waveform file. When the clock frequency is changed, even if you switch to table or timing display mode, the clock frequency there is changed too.

Linking the Vertical Bar Cursors

Cursor
Link to...

The **Cursor Link to...** item appears when two or more waveforms are being edited simultaneously. This item is used to link the movement of the vertical bar cursors in different editing areas. For example, when the cursors in editing area 1 are linked to those in editing area 2, moving the one of the cursors in editing area 1 will cause the corresponding cursor in editing area 2 to move the same distance. The following diagram shows the menu configuration.

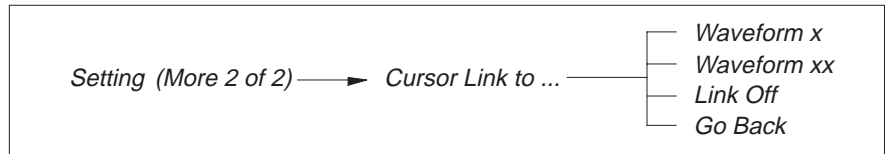

Figure 4A-21 shows a display in which two editing areas have been created and **Cursor Link to...** has been selected.

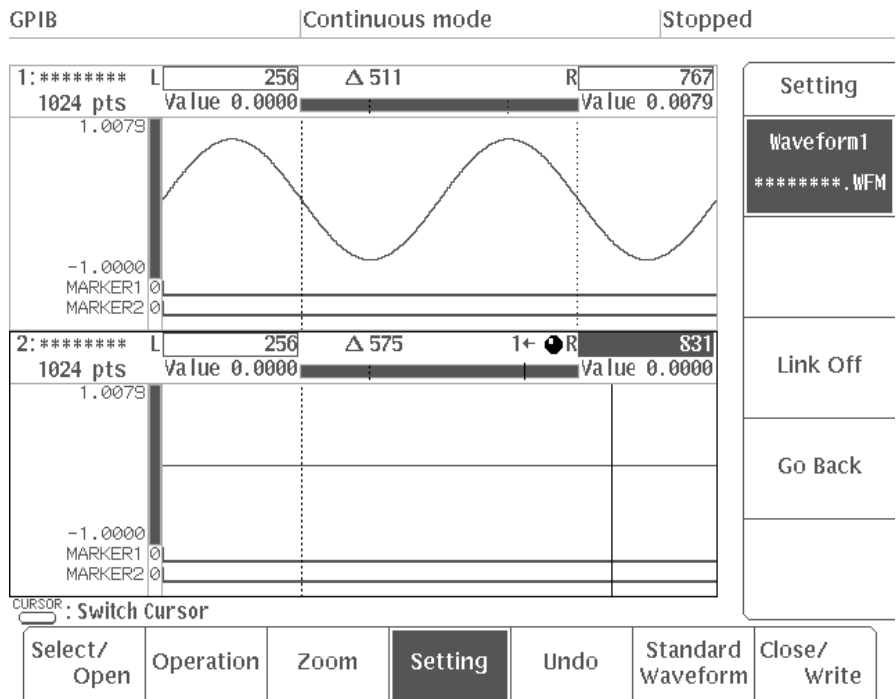

Figure 4A-21: Sub-Menu Display When Cursor Link to... is Selected

The 1← at the top of editing area 2 indicates that this area has been linked to editing area 1.

Procedure

In the following procedure, you will link the vertical bar cursors in editing area 2 (**Waveform2**) to the ones in editing area 1 (**Waveform1**) while editing area 1 is being edited.

- Step 1:** Select **Select/Open** from the bottom menu.
- Step 2:** Select **Waveform2** from the side menu.
- Step 3:** Select **Setting** from the bottom menu.
- Step 4:** Select **More** item to display **More 2 of 2** from the side menu and then select **Cursor Link to...**
- Step 5:** Select **Waveform1** from the sub-menu. **1←** will appear at the top of editing area 2.
- Step 6:** Select **Go Back** from the sub-menu. The **Setting** side menu will reappear.
- Step 7:** Select **Select/Open** from the bottom menu.
- Step 8:** Select **Waveform1** from the side menu.
- Step 9:** Press the front panel **CURSOR** button.
- Step 10:** Using the general purpose knob, move the active vertical bar cursor in editing area 1 and check to make sure that the vertical bar cursor in editing area 2 moves the same distance.

Procedure

In the following procedure, you will unlink the vertical bar cursors that you linked in the previous example while the waveform in editing area 1 is being edited.

- Step 1:** Select **Select/Open** from the bottom menu.
- Step 2:** Select **Waveform2** from the side menu.
- Step 3:** Select **Setting** from the bottom menu.
- Step 4:** Select **More** item to display **More 2 of 2** from the side menu and then select **Cursor Link to...**
- Step 5:** Select **Link Off** from the sub-menu. The link will be canceled and the **1←** at the top of editing area 2 will disappear.

Grid Off On

Displaying a Grid in the Editing Area

This item is used to display a grid in the editing area to make it easier to edit the waveform. The following diagram shows the menu configuration.

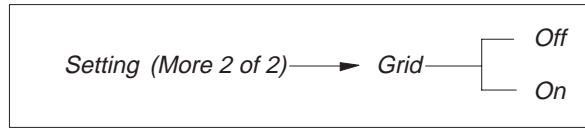

Figure 4A-22 shows an example of an editing area with the grid set to **On**.

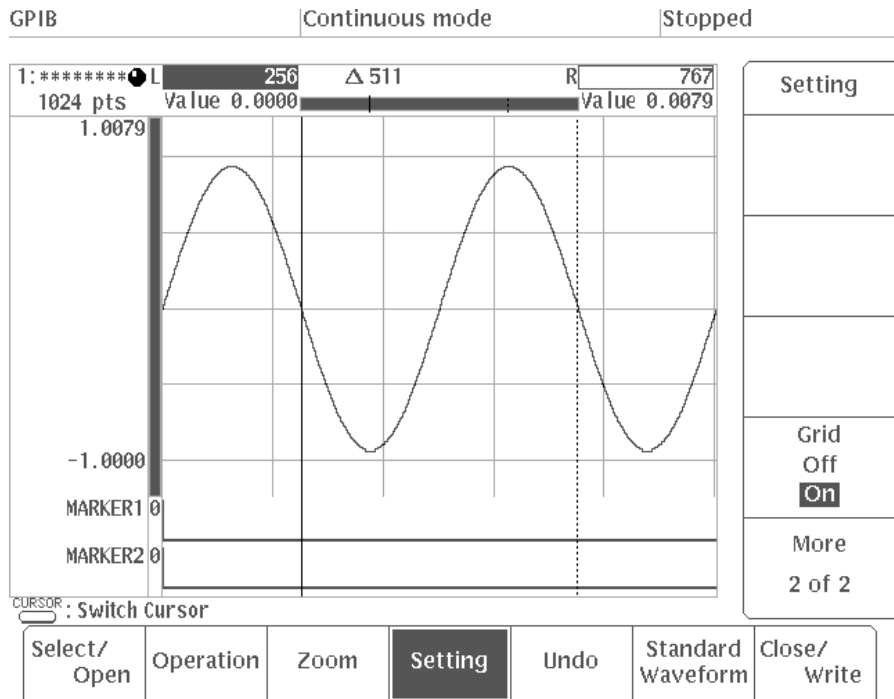

Figure 4A-22: Grid Set to On

- Step 1:** Select **Setting** from the bottom menu.
- Step 2:** Select **More** item to display **More 2 of 2** from the side menu.
- Step 3:** Press the **Grid** button in the side menu and select **On**. A grid will appear in the editing area.

NOTE. The grid can be turned on and off in timing display and table display as well, but the grid will only appear in graphic display.

Standard
Waveform

Creating a Standard Function Waveform

When you select the **Standard Waveform** item, a function waveform is created in the area between the specified vertical bar cursors, or a waveform is created through calculation of the original waveform and a function waveform.

When you select **Standard Waveform** from the bottom menu, the following items are displayed in the side menu. Some of the items will change depending on the settings. For example, if you press **Setting** in the bottom menu and **Horiz. Unit** in the side menu and then select **Point**, the **Cycle** item appears in the menu; if you press **Setting** and **Horiz. Unit** and select **Time**, the **Frequency** item appears in the menu.

- **Type** Used to select the type of function waveform
- **Cycle** Used to set the cycle
- **Frequency** Used to set the frequency
- **Amplitude** Used to set the amplitude
- **Offset** Used to set the offset
- **Execute** Used to execute the process (draw the waveform)

Type

Selecting Function Waveform Type and Calculation Method

The **Type** item is used to select the type of function waveform to be created and the calculation method. There are six choices for waveform type and three choices for calculation method, making a total of 18 different ways in which this item can be set.

Type of Function Waveform	Calculation Method
Sine wave(Sine)	Substitute
Triangle wave(Triangle)	Add(Add)
Square wave(Square)	Multiply(Mul)
Ramp wave(Ramp)	
Noise wave(Noise)	
DC(DC)	

- Example: **Sine** The data between the vertical bar cursors is replaced by a sine wave
- Add Sine** A sine wave is added to the data between the vertical bar cursors
- Mul Sine** The data between the vertical bar cursors is multiplied by a sine wave

Setting the Parameters for Function Waveforms

The following parameters can be set for each type of function waveform designated with the **Type** command. Note, however, that only amplitude and offset can be set for a **Noise** waveform, while only offset can be set for a **DC** waveform.

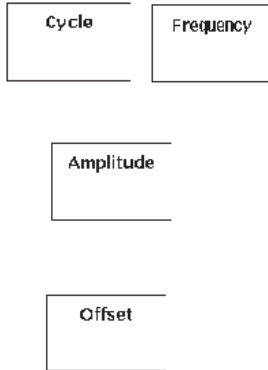

Cycle — 0.1 to 100,000 (in 0.1 increments)

Frequency — 200 Hz to $f/5$ (f = **Clock** frequency set with **Setting** menu item)

Amplitude — ± 2.0079 (if set to a negative number, the waveform will have inverse polarity)

Offset — -1.000 to $+1.0079$

Procedure 1: Creating a Sine Wave

In this example, you will replace the data between the vertical bar cursors with a sine wave. The procedure begins at the initial menu level.

- Step 1:** Select **New Waveform** from the side menu in the initial menu.
- Step 2:** Select **Standard Waveform** from the bottom menu.
- Step 3:** Check to make sure that the left and right vertical bar cursors are all the way to the left and right, respectively, to encompass the entire editing area. If they are not, use the general purpose knob to set them in this manner.
- Step 4:** Press the **Type** button in the side menu and select **Sine**.
- Step 5:** Select **Cycle** from the side menu. Use the numeric keys or the general purpose knob to set the number of cycles for the sine wave to 2.
- Step 6:** Select **Amplitude** from the side menu. Use the numeric keys or the general purpose knob to set the p-p amplitude for the sine wave to 1.
- Step 7:** Select **Execute** from the side menu.

When **Execute** is selected, the sine waveform is created between the vertical bar cursors with the set parameters. See Figure 4A-23.

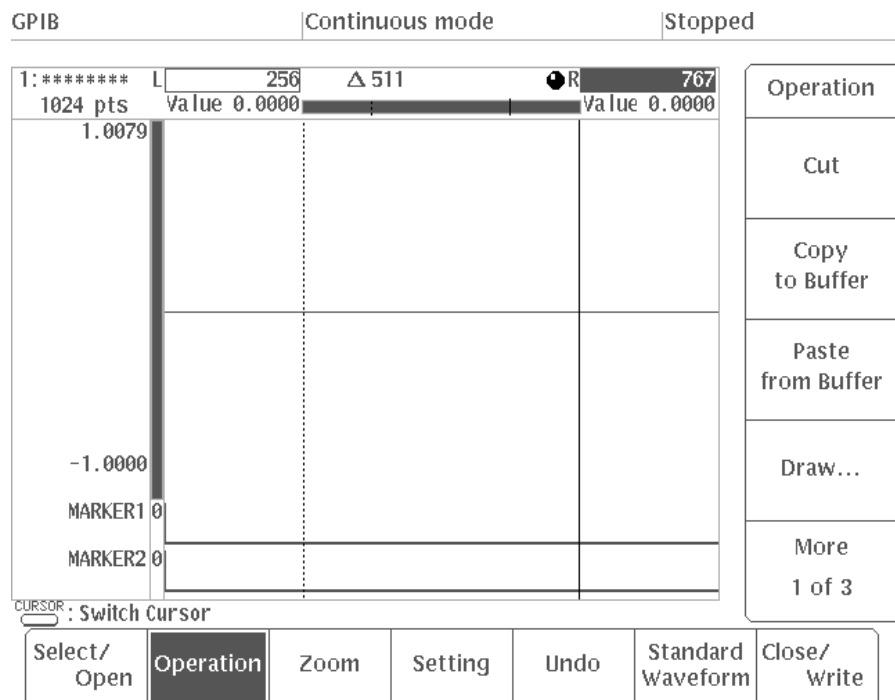

Figure 4A-23: Creating a Sine Wave

Procedure 2: Adding a Waveform to Existing Data

In this example, you will add noise to the sine wave you created in Procedure 1. The procedure starts from where you left off in Procedure 1.

- Step 1:** Select **Type** from the side menu. Turn the general purpose knob or press the **Type** button in the side menu and select **Add Noise**.
- Step 2:** Select **Amplitude** from the side menu. Using the numeric keys or the general purpose knob, set the p-p amplitude for the noise to 0.1.
- Step 3:** Select **Execute** from the side menu.

When you select Execute, a noise waveform will be added to the sine wave displayed between the left and right vertical bar cursors. See Figure 4A-24.

EDIT Menu

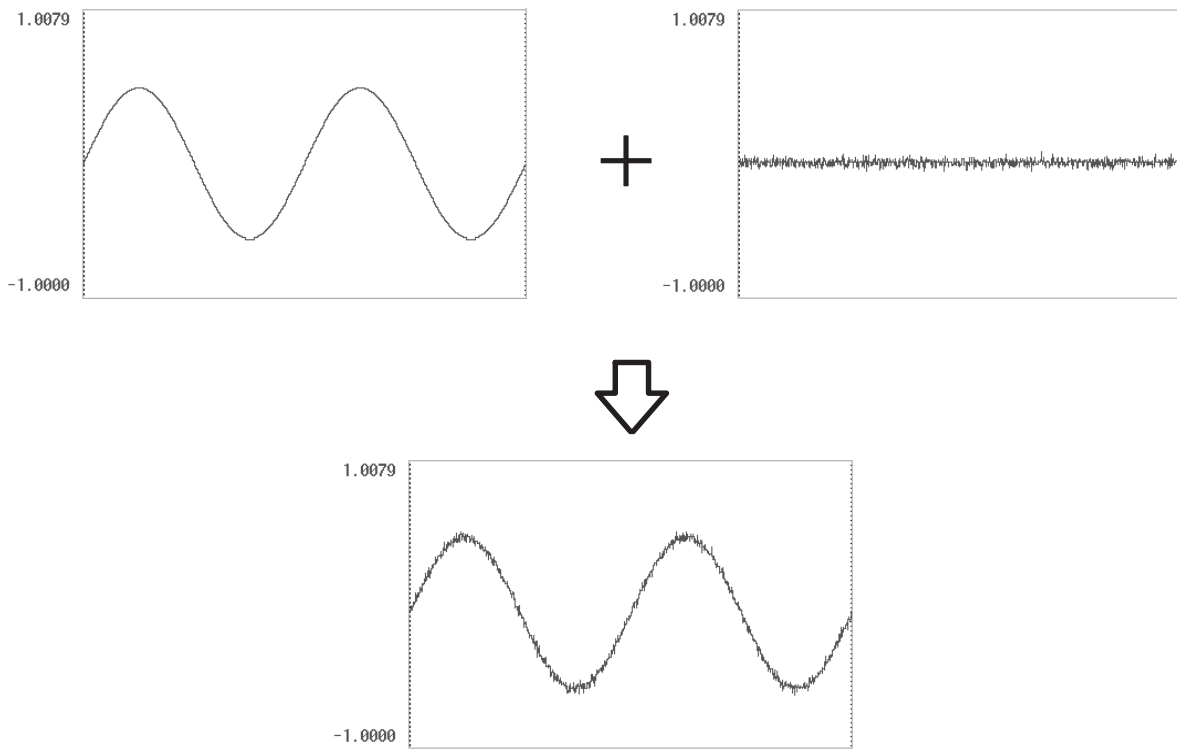

Figure 4A-24: Adding Noise to the Sine Wave

NOTE. Portions of the waveform that protrude outside the editing area when the other waveform is added will be clipped.

Procedure 3: Multiplying Waveforms

In this example, you will multiply the sine wave you created in Procedure 1 by another sine wave with a different frequency. The procedure starts from where you left off in Procedure 2.

- Step 1:** Select **Undo** from the bottom menu. This will eliminate the noise waveform added in Step 2.
- Step 2:** Select **Type** from the side menu. Turn the general purpose knob or press the **Type** button in the side menu and select **Mul Sine**.
- Step 3:** Select **Cycle** from the side menu. Using the numeric keys or the general purpose knob, set the number of cycles for the sine wave to 30.
- Step 4:** Select **Amplitude** from the side menu. Using the numeric keys or the general purpose knob, set the p-p amplitude for the sine wave to 1.
- Step 5:** Select **Execute** from the side menu.

When you select **Execute**, the sine wave between the vertical bar cursors will be multiplied by the different frequency sine wave. See Figure 4A-25.

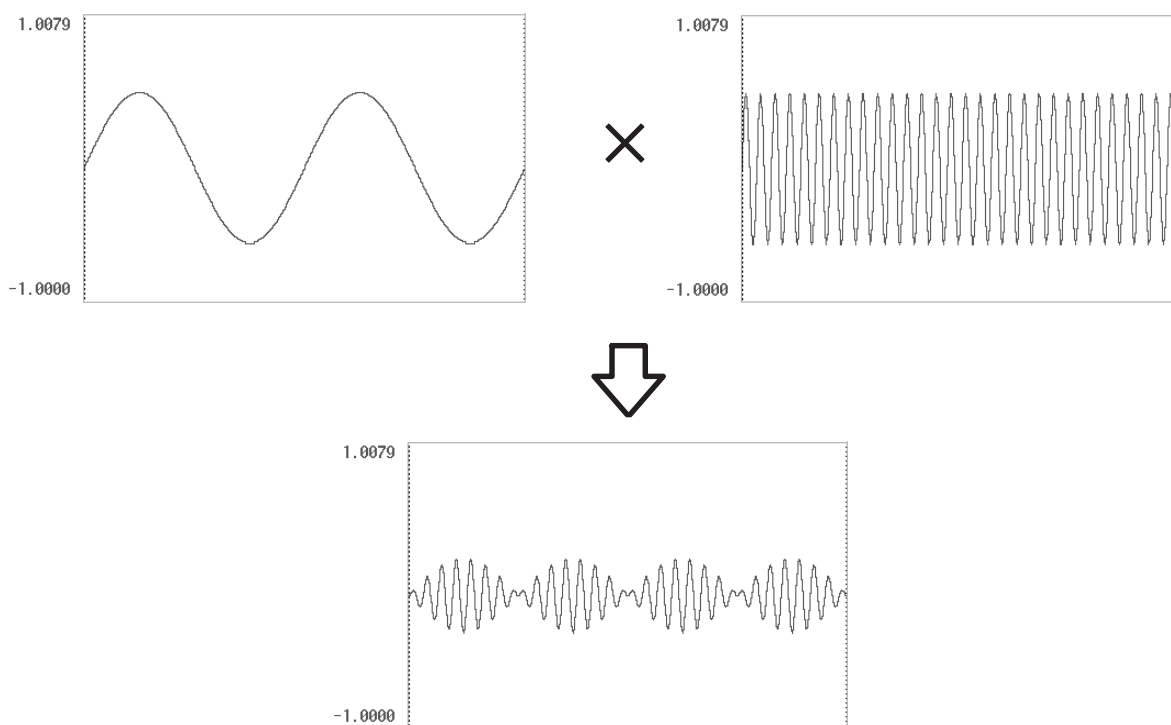

Figure 4A-25: Multiplying Sine Waves

Editing Waveforms in Graphic Display

When **Operation** is selected with the waveform editor set to Graphic display, it is possible to edit the waveform data in various ways.

The side menu has four pages. Select **More** to switch the side menu to the next page. The following is a list of the items in the side menu and their functions.

■ Cut	Cutting waveform
■ Copy to Buffer	Copying waveform
■ Paste from Buffer	Pasting waveform
■ Draw...	Draw function
■ Shift...	Shift function
■ Scale...	Scaling function
■ Invert...	Invert function
■ Clip...	Clip function
■ Marker...	Setting a marker
■ Insert Other Waveform	Inserting other waveform
■ Single Waveform Math...	Single waveform calculations
■ Dual Waveform Math....	Calculations with other waveform data
■ Region Shift...	Specified region shift function

When editing two or more waveforms simultaneously, three more items are added to the side menu (and the size of the menu increases to four pages).

■ Multiple Copy...	Multiple copy
■ Convolute...	Convolution calculation
■ Compare...	Comparing waveforms

Items with “...” have further low-level side menu, called sub-menu.

Setting Editing Areas

The editing operations available under **Operation** are all performed in the editing area located between the left and right vertical bar cursors. Before beginning the editing process, you should define the editing area using the following procedure.

Procedure

- Step 1:** Select **Operation** from the bottom menu.
- Step 2:** Press the **CURSOR** button on the front panel to make the left vertical cursor active (solid line).
- Step 3:** Using the numeric keys or the general purpose knob, move the left cursor to the starting point for the editing operation you wish to perform.
- Step 4:** Press the **CURSOR** button on the front panel again to make the right vertical cursor active (solid line).
- Step 5:** Using the numeric keys or the general purpose knob, move the right cursor to the endpoint for the editing operation you wish to perform.

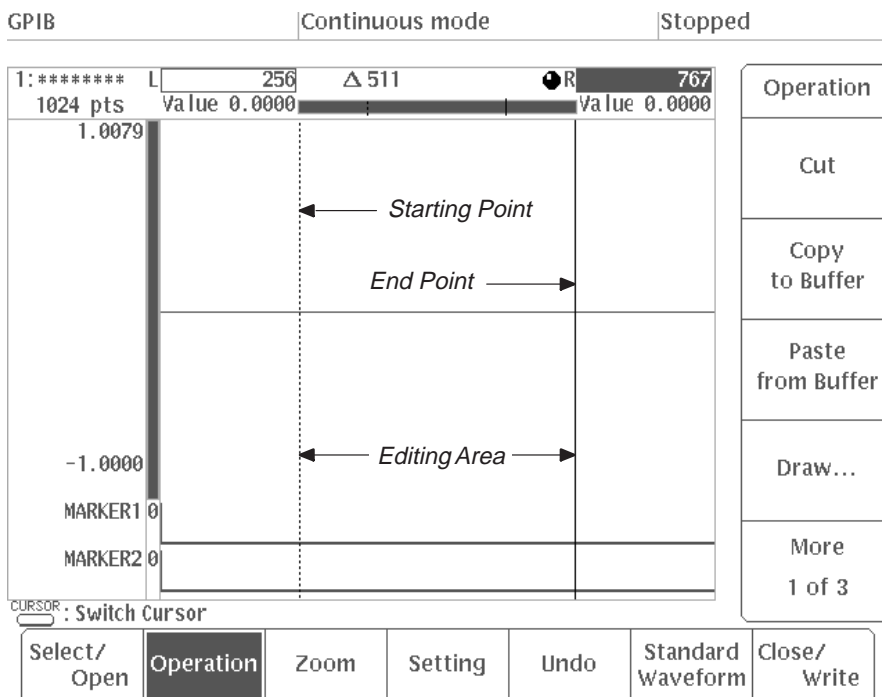

Figure 4A-26: Defining the Editing Area

Subsequent editing operations will be performed in the area that you have set between the left and right vertical bar cursors.

The following section will describe each of the items in the side menu in detail.

Cutting Waveforms

cut

This command is used to remove a portion of the waveform from the editing area. The following diagram shows the menu configuration.

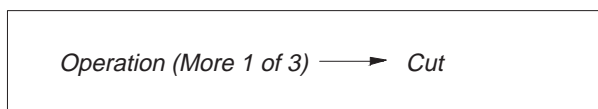

Move the right and left vertical bar cursors to define the area you wish to cut and then select **Cut** from the side menu. There is no sub-menu for this command; when it is selected, the section of the waveform that you have defined is cut instantly. Marker signals associated with that waveform data are also cut. Removing part of a waveform will naturally reduce the number of points in that waveform.

Figure 4A-27 shows an example of a waveform before and after a section is cut. Note that only the section between the two vertical bar cursors is removed including the bar cursors.

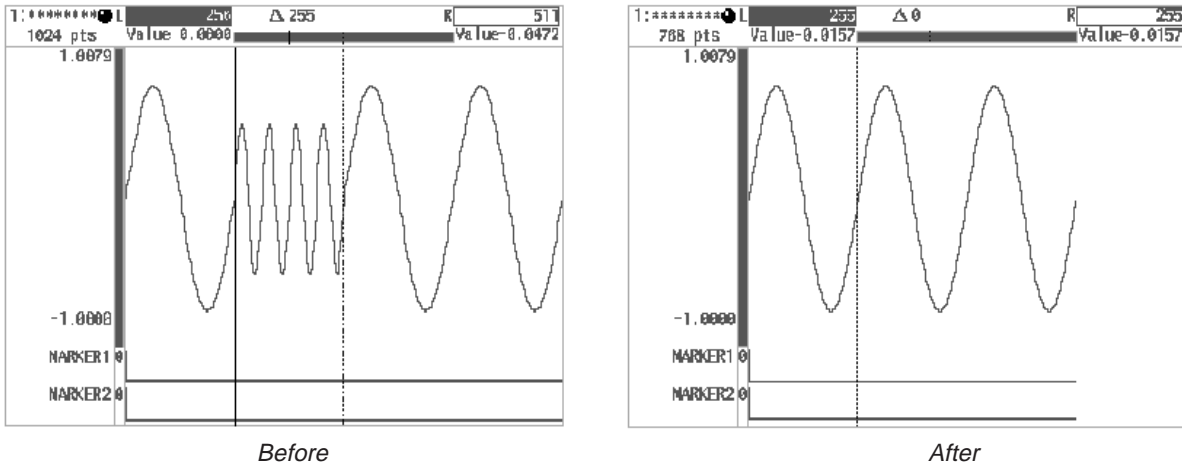
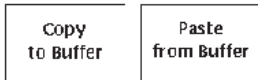

Figure 4A-27: Cutting Waveforms

Waveform data that has been cut is stored in the paste buffer. You can paste this data into another editing area (by selecting **Paste from Buffer**), insert it into another waveform (by selecting **Insert Other Waveform**) or use it to perform calculations with another waveform (by selecting **Math**).

NOTE. If you cut out waveform data by mistake, select **Undo** from the bottom menu to restore the original waveform data.

Copying/Pasting Waveforms



Use the **Copy to Buffer** and **Paste from Buffer** items to copy the edited waveform area and paste it to another location. The following diagram shows the menu configuration.

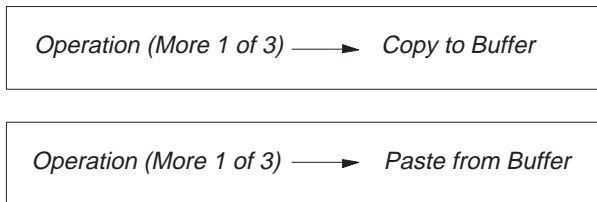

There are no sub-menus associated with these commands; when they are selected, the copy or paste operation is performed instantly. Marker signals associated with that waveform data are also subjected to the copy and paste operations. Pasting data into a waveform will naturally increase the number of points in that waveform.

Procedure

- Step 1:** Specify the waveform to be copied with the left and right vertical bar cursors. Select **Copy to Buffer** from the displayed side menu.

When **Copy to Buffer** is selected, the waveform data between the vertical bar cursors (including the left and right vertical bar cursor data) is copied into the paste buffer. Marker signals associated with that waveform data are also subjected to the copy and paste operations. This operation does not affect the display on the CRT.

- Step 2:** Press the **CURSOR** button on the front panel.
- Step 3:** Use the general purpose knob to specify the position to paste the data with whichever of the vertical bar cursors is active.

The data is pasted directly before the active vertical bar cursor. However, when the cursor is at the end of the waveform, the data is inserted directly after the cursor.

- Step 4:** Select **Paste from Buffer** from the side menu.

Figure 4A-28 shows an example of a waveform before and after additional data is pasted into that waveform.

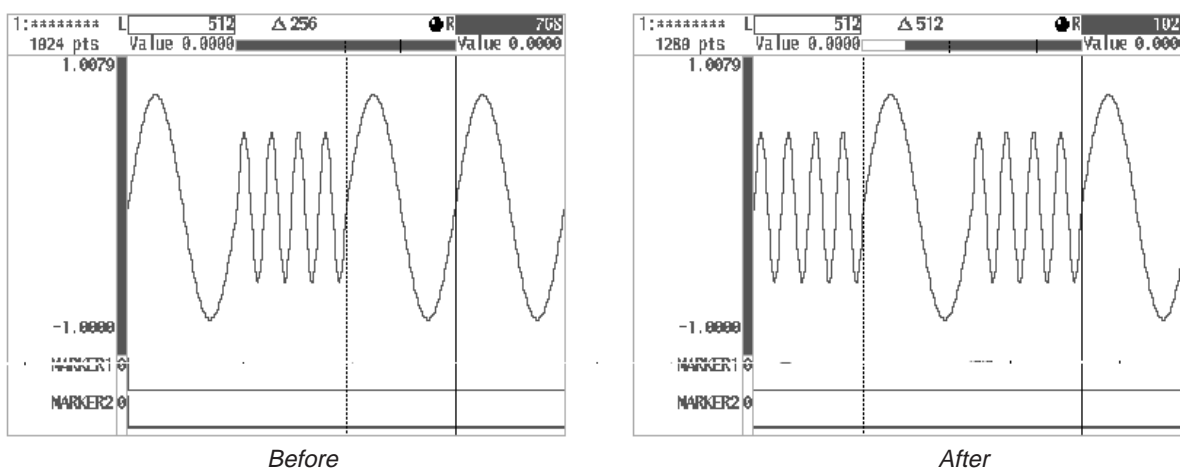

Figure 4A-28: Pasting Waveforms

When you select **Paste from Buffer**, the waveform data copied to the paste buffer in the Copy process will be inserted in front of the active vertical bar cursor. When the active vertical bar cursor is at the end of the waveform, the data will be inserted after the active vertical bar cursor.

The paste buffer data can be inserted into a waveform or used for operations with waveforms by selecting **Insert Other Waveform** or **Math** from the **Operation** menu.

Draw Function

Draw...

This command is used to draw points between the specified vertical bar cursors and connect these points to create an arbitrary waveform. The following diagram shows the menu configuration for the **Draw...** item.

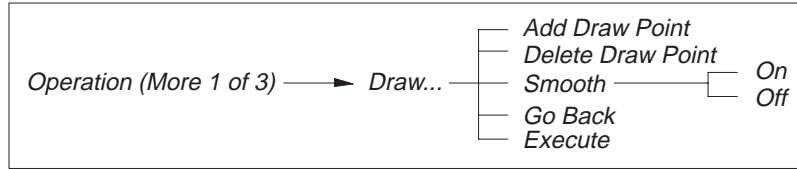

Figure 4A-29 shows an example of the screen with the **Draw...** item selected. This figure will be discussed in the following section.

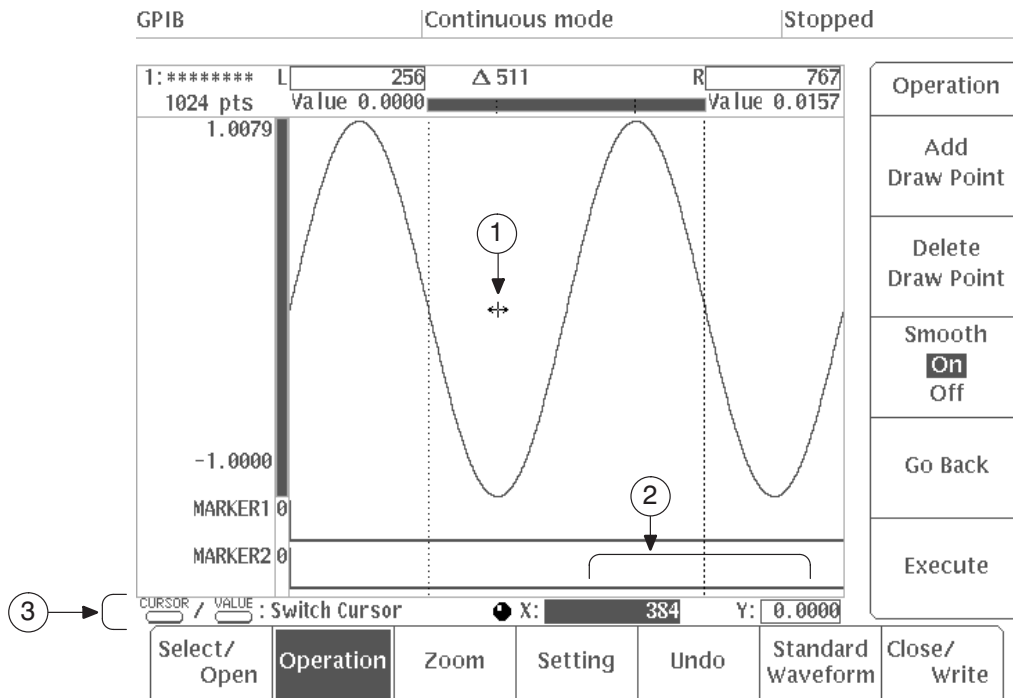

Figure 4A-29: Menu Display When Draw... Item is Selected



(1) Point Cursor

Used to draw points. When this cursor can be moved, the direction in which it can be moved is shown by the arrows.

(2) X-Y Coordinate Axis

Shows the X and Y coordinates of the point cursor described in (1) above. When the coordinates for a coordinate axis are displayed inverted, it indicates that the cursor can be moved in that direction.

(3) Button Operations

  : Switch Cursor

Pressing the **CURSOR** button toggles the active vertical bar cursor from left to right and back again. Pressing the **VALUE** button toggles the direction in which the point cursor can be moved from up-down to left-right and back again.

Procedure

- Step 1:** Move the left and right vertical bar cursors to define the area within which the waveform will be drawn and then select **Draw...** from the side menu.

The point cursor will appear in the middle of the vertical axis between the left and right vertical bar cursors.

- Step 2:** Press **VALUE** button on the front panel.
- Step 3:** Use the general purpose knob to move the point cursor to the location where you want to place a point.

Each time the **VALUE** button on the front panel is pressed, the direction of movement for the point cursor switches between horizontal (X) and vertical (Y). The X-Y coordinates for the point cursor position are displayed at the bottom right of the CRT display.

- Step 4:** Select **Add Draw Point** from the sub-menu to place the draw point.

Draw points can be placed outside the left and right vertical bar cursors. However, such points are not drawn when Execute is pressed.

NOTE. You cannot set multiple draw points above the same horizontal position. If you try to do so, the system asks you if you want to change the level for the point already above the horizontal position. To do so, select **O.K.** To abort the operation, select **Cancel**.

- Step 5:** Repeat Steps 3 and 4 to place as many points as desired.

- Step 6:** To delete a draw point added with **Add Draw Point**, move the point cursor to the point to be deleted, then select **Delete Draw Point**. This deletes the point.

If **Delete Draw Point** is pressed repeatedly, the added points closest to the point cursor are deleted in order.

- Step 7:** Press the **Smooth** button in the sub-menu to switch on smoothing.

- Smoothing — Smoothing can be toggled on or off by pressing the **Smooth** button. When smoothing is on, the waveform data is spline interpolated and the curve outside the left and right vertical bar cursors and the placed points are connected with a smooth curve. When smoothing is off, the interpolation is linear and the curve outside the left and right vertical bar cursors and the placed points are connected with a straight line. When the vertical bar cursors are at both ends of the waveform being edited, the start and end point of the waveform are given the value to be smooth waveform as the repetition waveforms regardless of whether smoothing is set to on or off.
- Step 8:** Select **Execute** from the sub-menu. The points between the vertical bar cursors will be connected with smooth curves, as shown in the left screen in Figure 4A-30. This is called spline interpolation.
- Step 9:** To return to the original waveform, select **Undo** from the bottom menu.
- Step 10:** Press the **Smooth** button in the sub-menu to switch off smoothing.
- Step 11:** Select **Execute** from the sub-menu. The points between the vertical bar cursors will be connected with straight lines, as shown in the right screen in Figure 4A-30. This is called linear interpolation.

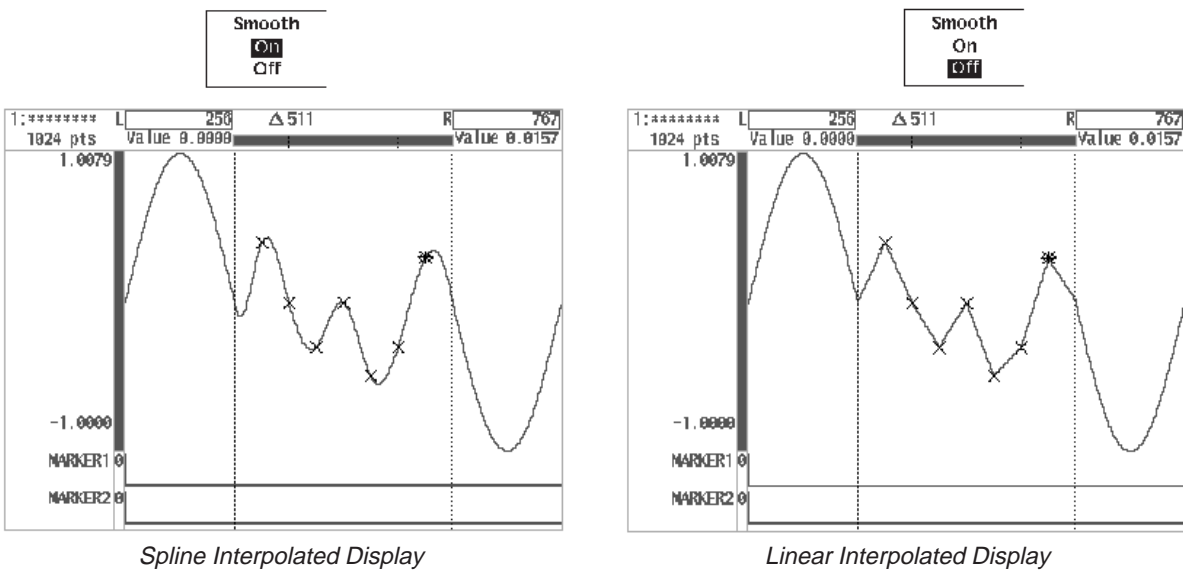

Figure 4A-30: Smoothing

NOTE. To cancel drawing execution, select **Undo** from the bottom menu. The waveform before the drawing is displayed again.

- Step 12:** Select **Go Back** from the current sub-menu. The display moves from the **Draw...** sub-menu to the side menu.

This completes the drawing procedure.

Shift Function

Shift...

Use **Shift...** to shift the waveform data in the area specified with the vertical bar cursors in the vertical or horizontal direction. The following diagram shows the menu configuration for the **Shift...** item.

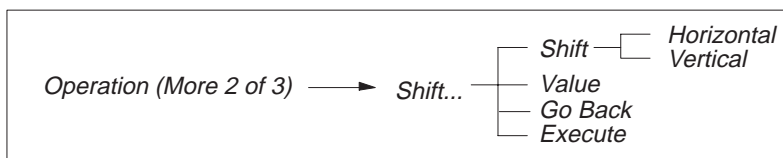

In the horizontal direction, the shift value is the number of points or time; in the vertical direction, the shift value is specified with the vertical value.

Procedure

- Step 1:** Move the left and right vertical bar cursors to define the section of the waveform to be shifted. Then select **Shift...** from the second page of the side menu (**More 2 of 3**).

Shift
Horizontal
Vertical

Horizontal shift

- Step 2:** Press the **Shift** button in the sub-menu to select **Horizontal**.

The **Shift** sub-menu item selects the direction in which the waveform data between the vertical bar cursors is to be shifted.

- Step 3:** Select **Value** from the sub-menu.
- Step 4:** Use the general purpose knob or the numeric keys to input the shift point value. This value will be expressed as either number of points or time, depending on the horizontal unit setting (the value set with **Horiz. Unit** under **Setting**).
 - Horizontal shift – This command allows you to shift all of the points or time values in the whole editing area; it can be set to either a positive or a negative value. When the shift value is positive, the waveform moves to the right; when it is negative, the waveform moves to the left. Data that protrudes outside the range defined by the vertical bar cursors as a result of shifting is added to the end of either the right or left vertical bar cursor, depending on whether the shift value is positive or negative.
- Step 5:** Select **Execute** from the sub-menu. The waveform is shifted horizontally with the specified conditions.

Figure 4A-31 shows the waveform between the vertical bar cursors shifted right 128 points.

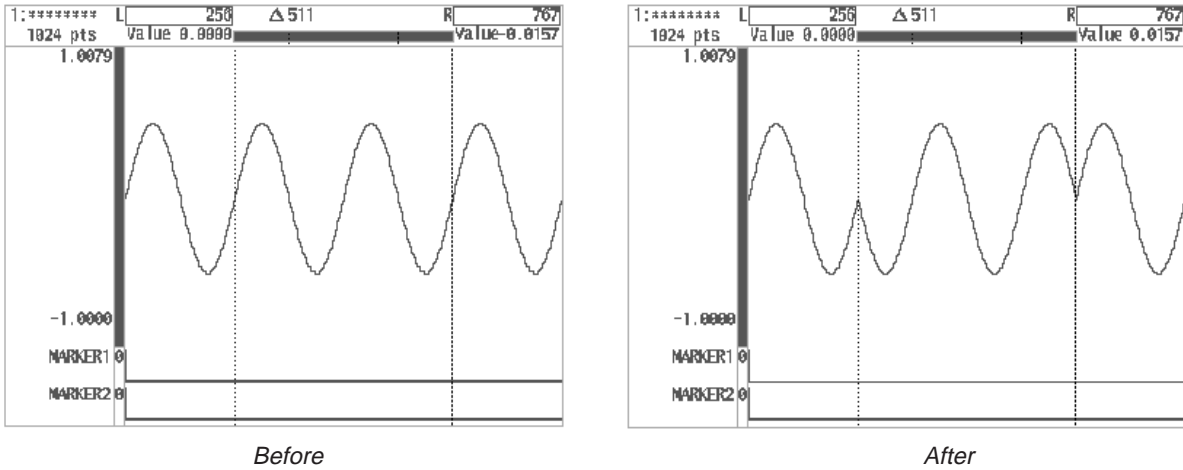
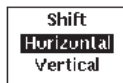

Figure 4A-31: Horizontally Shifted Display



Vertical shift

- Step 6:** Press the **Shift** button in the sub-menu to select **Vertical**.
- Step 7:** Select **Value** from the sub-menu. Use the general purpose knob or the numeric keys to input the shift point value.
 - Vertical shift – The waveform can be shifted between -1.0000 and $+1.0079$ for the full scale of the vertical axis. A positive shift moves the waveform up, a negative shift down. However, any points shifted beyond the vertical full scale are clipped.
- Step 8:** Select **Execute** from the sub-menu. The waveform is shifted vertically with the specified conditions. Figure 4A-32 shows the waveform between the vertical bar cursors shifted up 0.3 point.

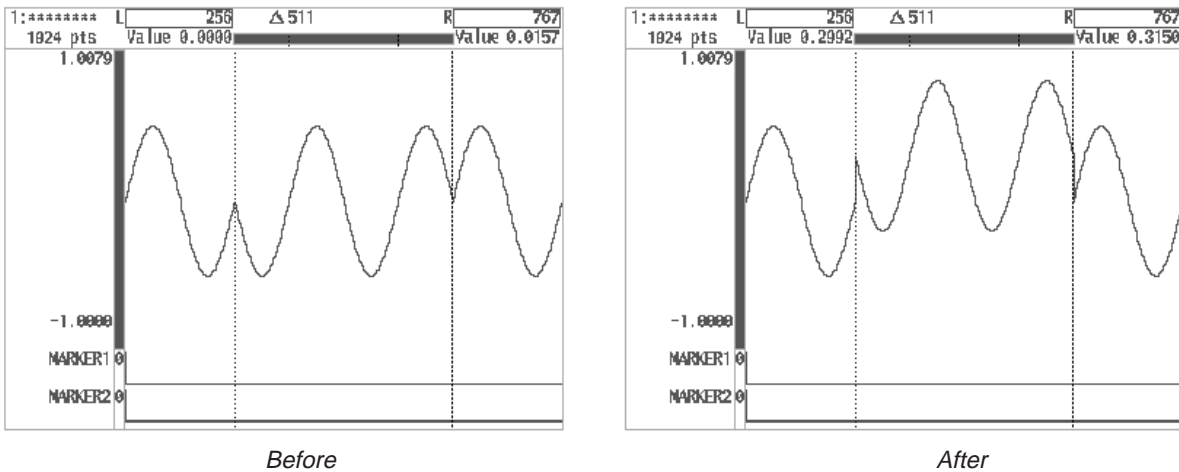
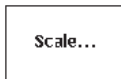

Figure 4A-32: Vertically Shifted Display

- Step 9: Select **Go Back** from the sub-menu.

Scaling Function



Use **Scale...** to change the scale for the waveform data between the vertical bar cursors. Executing scaling changes the waveform data. The following diagram shows the menu configuration for the **Scale...** item.

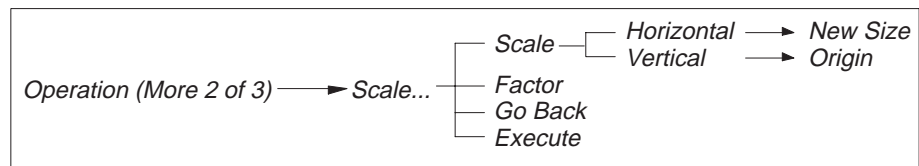

Procedure

- Step 1:** Move the left and right vertical bar cursors to define the editing area for scaling, then select **Scale...** from the second page of the side menu (**More 2 of 3**).



Horizontal Scaling

- Step 2:** Press the **Scale** button in the sub-menu to select **Horizontal**.

The **Scale** sub-menu item selects the direction in which the data between the vertical bar cursors is scaled.

- Step 3:** Select **Factor** or **New Size** from the sub-menu.

The magnification for scaling can be set with either **Factor** or **New Size**.

- Factor** – The waveform data between the vertical bar cursors is expanded/reduced by this ratio. This parameter is linked with **New Size**. Factor can be set within the range ± 100 in steps of 0.01. However, the total number of points for the entire waveform can not exceed 262144, so if x100 scaling would give more total points than that, the maximum setting factor drops to the one that gives 262144 points. A negative factor reverses the waveform between the vertical bar cursors creating a mirror image.

Scaling with a factor under 1.00 and greater than -1.00 (± 0.99) reduces the waveform horizontally between the vertical bar cursors and reduces the number of points for the entire waveform. Scaling with a factor greater than 1.00 or less than -1.00 expands the waveform horizontally between the vertical bar cursors and increases the number of points for the entire waveform.

- New Size** – This parameter expands/reduces the waveform data between the vertical bar cursors in units of points. This parameter is linked with **Factor**. The limit on the range of **New Size** is that the number of points between the vertical bar cursors can not be increased to more than x100 their original number and the number of points for the entire waveform can not exceed 262144.

Step 4: Use the numeric keys or general purpose knob to input the scaling factor or the number of points.

Step 5: Select **Execute** from the sub-menu. The section of the waveform between the vertical bar cursors will be scaled horizontally in the right direction from the left vertical bar cursor.

Figure 4A-33 shows a waveform expanded to x2 horizontally between the vertical bar cursors with the **Factor**.

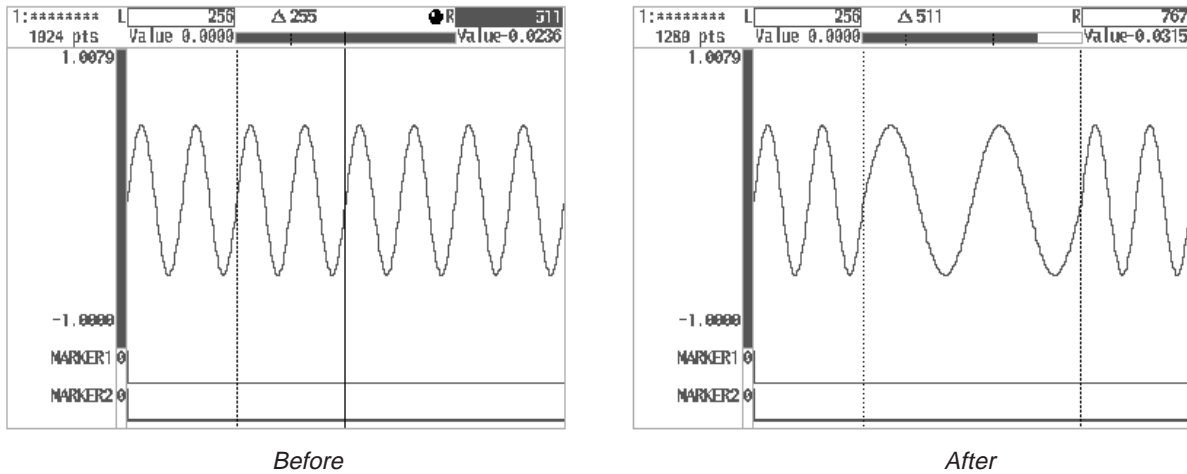

Figure 4A-33: Display Expanded Horizontally



Vertical Scaling

- Step 6:** Press the **Scale** button in the sub-menu to select **Vertical**.
- Step 7:** Select **Origin** from the sub-menu. Use the numeric keys or the general purpose knob to input the numeric value of the origin.
 - **Origin** – This value is used as a reference when scaling vertically. It may be set to any value between -1.0000 and $+1.0079$ for the full scale of the vertical axis.
- Step 8:** Select **Factor** from the sub-menu.
- Step 9:** Use the numeric keys or general purpose knob to input the scaling factor.
 - **Factor** – Factor can be set within the range ± 100 in steps of 0.01. A negative factor causes the waveform between the vertical bar cursors to produce a mirror image about the origin value.

Scaling with a factor under 1.00 and greater than -1.00 (± 0.99) reduces the waveform vertically between the vertical bar cursors. Scaling with a factor greater than 1.00 or less than -1.00 expands the waveform vertically between the vertical bar cursors. Waveform data pushed beyond the full scale of the vertical axis by scaling is clipped.

- Step 10:** Select **Execute** from the sub-menu. The waveform is scaled with the specified conditions.

Figure 4A-34 shows an example of **Factor** being used to enlarge the section of the waveform between the vertical bar cursors. In this example, the waveform has been enlarged 1.5 times vertically around the reference line.

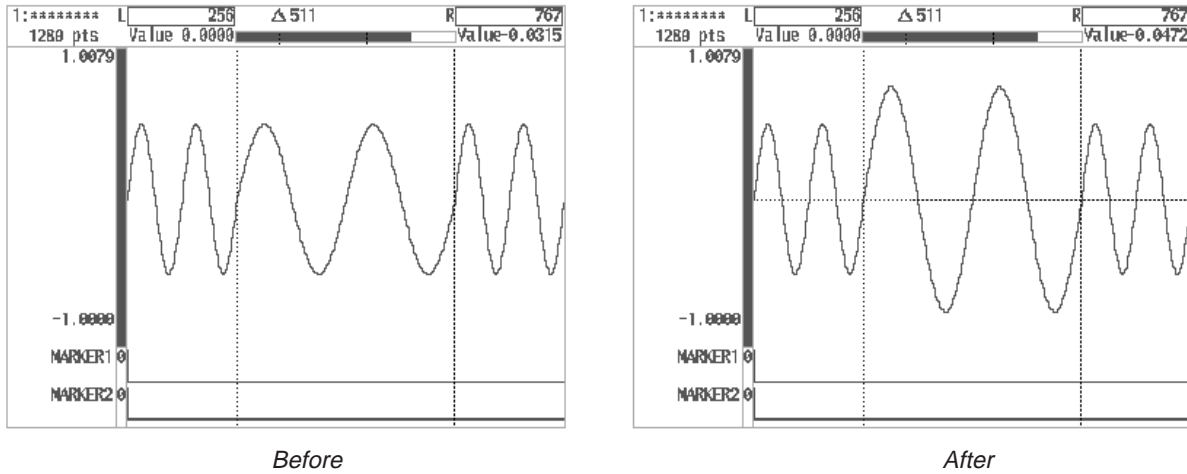

Figure 4A-34: Display Expanded to x1.5 Vertically

- Step 11:** Select **Go Back** from the sub-menu. The system moves from the **Scale...** sub-menu to the previous side menu.

Invert...

Invert Function

Use **Invert...** to invert the waveform data in the area specified with the vertical bar cursors either up/down or left/right. The following diagram shows the menu configuration for the **Invert...** item.

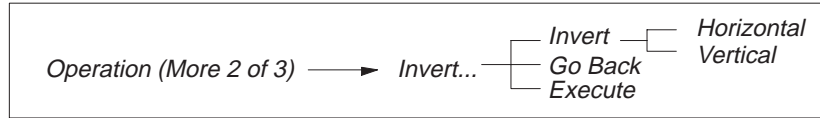

Procedure

- Step 1:** Move the left and right vertical bar cursors to define the editing area for inversion, then select **Invert...** from the second page of the side menu (**More 2 of 3**).

Invert
Horizontal
Vertical

Inverting the waveform horizontally

- Step 2:** Press the **Invert** button in the sub-menu to select **Horizontal**.

The **Invert** selects the direction in which the waveform data between the vertical bar cursors is inverted.

- Step 3:** Select **Execute** from the sub-menu. The waveform is inverted horizontally with the specified conditions. Figure 4A-35 shows an example of the waveform before and after it is inverted horizontally.

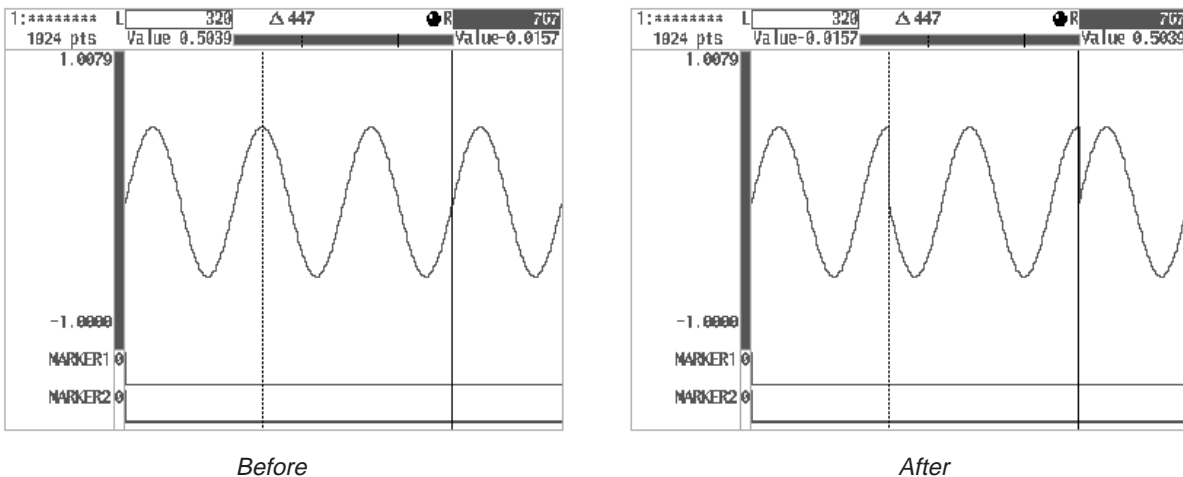

Figure 4A-35: Horizontally Inverted Display



Inverting the waveform vertically

- Step 4:** Press the **Invert** button in the sub-menu to select **Vertical**.
- Step 5:** Select **Execute** from the sub-menu. The waveform is inverted vertically with the specified conditions. Figure 4A-36 shows an example of the waveform before and after it is inverted vertically.

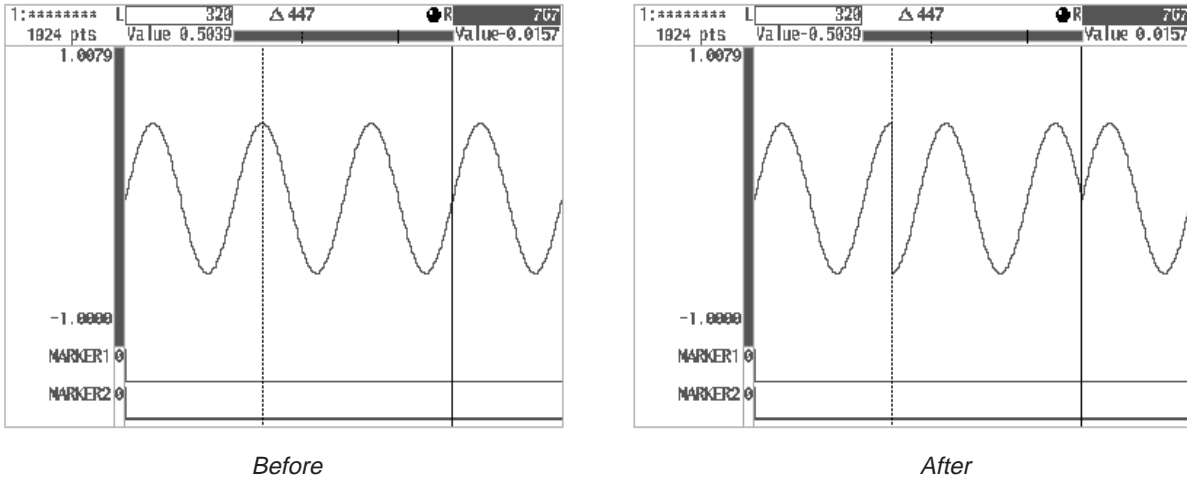

Figure 4A-36: Vertically Inverted Display

- Step 6:** Select **Go Back** from the current sub-menu. The display returns from the **Invert...** sub-menu to the side menu.

clip...

Clip Function

Use **Clip...** to clip (remove) any waveform data between the vertical bar cursors that is above or below the set level. The following diagram shows the menu configuration for the **Clip...** item.

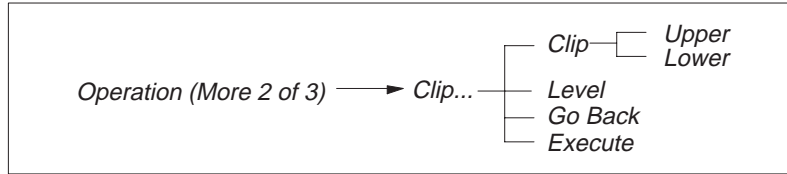

Procedure

- Step 1:** Move the left and right vertical bar cursors to define the editing area for clipping, then select **Clip...** from the second page of the side menu (**More 2 of 3**). A horizontal (broken) line showing the clip level will appear.
- Step 2:** Press the **Clip** button in the sub-menu to select **Upper** or **Lower**.
The **Clip** sub-menu item selects the area of the waveform data between the vertical bar cursors to be clipped. Either the area above the clip level (**Upper**) or below the clip level (**Lower**) can be selected.
- Step 3:** Select **Level** from the sub-menu.
- Step 4:** Use the numeric keys or the general purpose knob to input the clip level.
- Step 5:** Select **Execute** from the sub-menu. The waveform is clipped with the specified conditions. Figure 4A-37 shows the waveform clipped above 0.3.

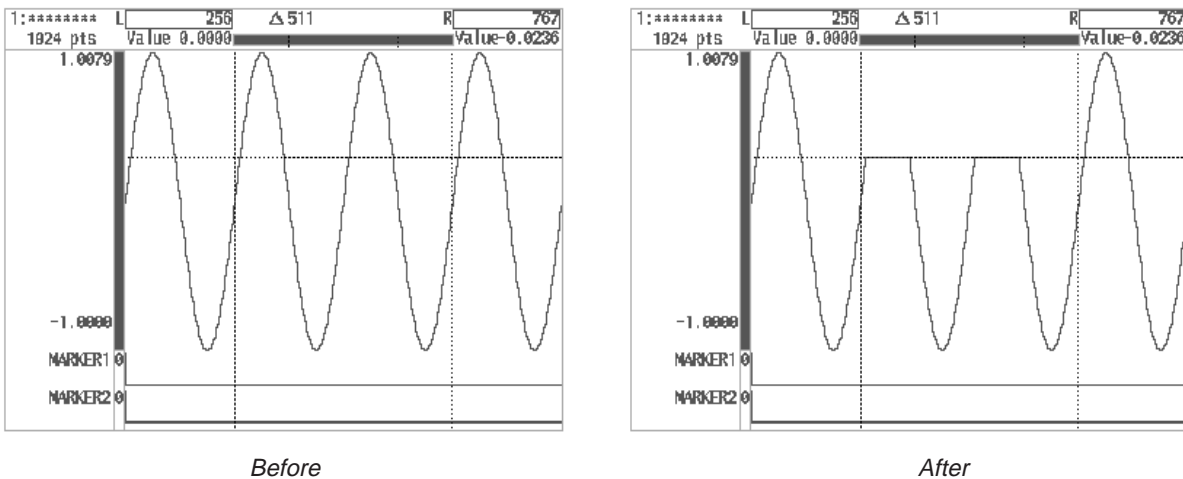

Figure 4A-37: Display of Waveform Clipped Above Clip Level

- Step 6:** Select **Go Back** from the sub-menu. The display returns from the **Clip...** sub-menu to the side menu.

Setting a Marker

Marker...

The **Marker...** item is used to set the marker signal (shown at the bottom of the screen) for the section of the waveform between the vertical bar cursors. This signal may be set to high, low or pattern. The following diagram shows the menu configuration for the **Marker...** item.

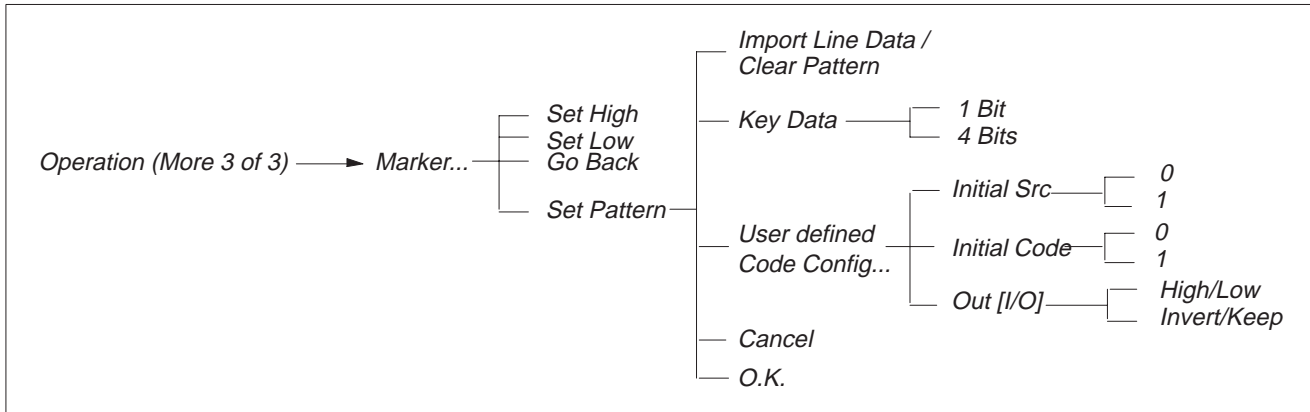

NOTE. When a new waveform file is created, the marker signal for the first point of the waveform data is set to high as a default value.

The output level for the marker signal is set using **Marker Level** in the **SETUP** menu. With 50Ω termination, the high level can be set between 2.0 and -1.9 V, while the low level can be set between 1.9 and -2.0 V. The marker signals are output from the **CH1 MARKER 1** and **CH1 MARKER 2** connectors on the front panel.

Procedure

- Step 1:** Move the left and right vertical bar cursors to define the area for marker setting, then select **Marker...** from the third page of the side menu (**More 3 of 3**).
- Step 2:** Press **Marker** in the side menu and select which marker signal is to be set (**MARKER 1** or **MARKER 2**).
- Step 3:** Press the sub-menu **Set High** or **Set Low** button to set the desired marker state. Figure 4A-38 shows marker signal set high between the vertical bar cursors.

Set High — The marker signal for the section of the waveform between the vertical bar cursors will be set to High.

Set Low — The marker signal for the section of the waveform between the vertical bar cursors will be set to Low.

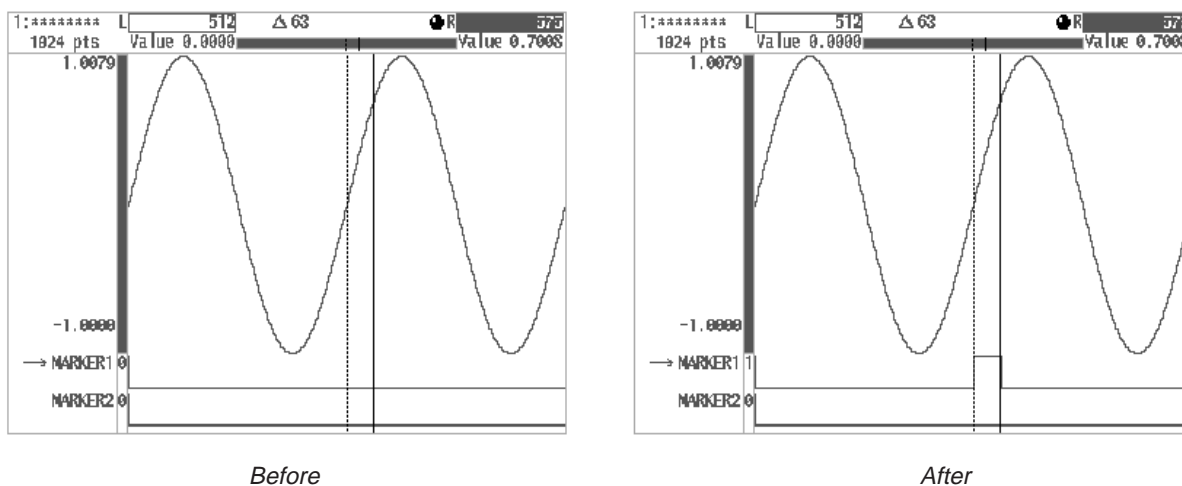

Figure 4A-38: Marker Signal Set High

- Step 4:** Select **Go Back** from the sub-menu. The display returns from the **Marker...** sub-menu to the side menu.

Setting a Marker Pattern

In this example, you will set a pattern for the marker and then create a marker signal with that pattern used as the period. Marker patterns are set with the **Set Pattern** item.

Procedure

- Step 1:** Move the left and right vertical bar cursors to define the area for setting a marker pattern, then select **Marker...** from the third page of the side menu (**More 3 of 3**).
- Step 2:** Press **Marker** in the sub-menu and select which marker signal is to be set (**MARKER 1** or **MARKER 2**).
- Step 3:** Select **Set Pattern** from the sub-menu. The sub-menu for this item will appear.
- Step 4:** Using the numeric keys, enter the data for the marker pattern. Data can be entered in either 1-bit or 4-bit increments.

Key Data — Pressing this button toggles the increment setting from **1 Bit** to **4 Bits** and back again.

Import Line Data/Clear Pattern — Pressing the **Import Line Data** button imports the marker data for the designated editor as pattern data. When this is done, the menu item will change to **Clear Pattern**. This command is used to delete all of the pattern data that has been imported or created. When the **Clear Pattern** button is pressed to delete the pattern data, the menu item changes back to **Import Line Data**.

User defined Code Config... — Used to define a custom conversion table for code conversion.

For detailed instructions on pattern setting, see "Setting Pattern Data" in the timing display in this section as well as "Pattern Codes" in Appendix D.

Figure 4A-39 shows an example of pattern data being entered.

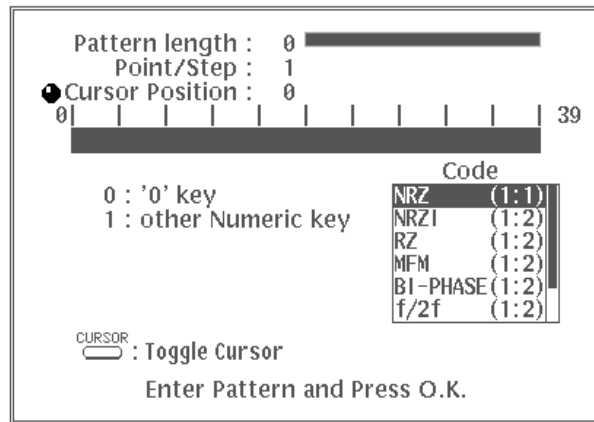

Figure 4A-39: Entering Pattern Data

- Step 5:** When you have finished creating the pattern data, select **O.K.** The marker data between the left and right vertical bar cursors will be replaced with the pattern data that you have created. To cancel the operation, select **Cancel**. Whichever option you select **O.K.** or **Cancel**, the menu that was displayed before **Set Pattern** was selected will reappear.
- Step 6:** Select **Go Back** from the sub-menu. The display returns from the **Marker...** sub-menu to the side menu.

Insert
Other
Waveform

Inserting Other Waveforms

Use **Insert Other Waveform** to insert other waveforms into any desired location within the waveform being edited. The following diagram shows the menu configuration.

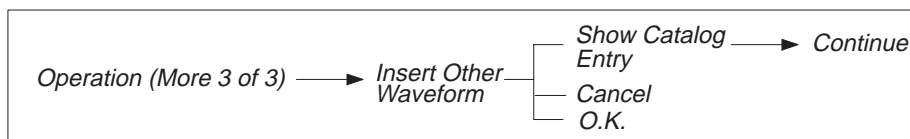

Procedure

- Step 1:** Press the **CURSOR** button on the front panel.
- Step 2:** Use the general purpose knob to move the active vertical bar cursor to the position where the other waveform is to be inserted.

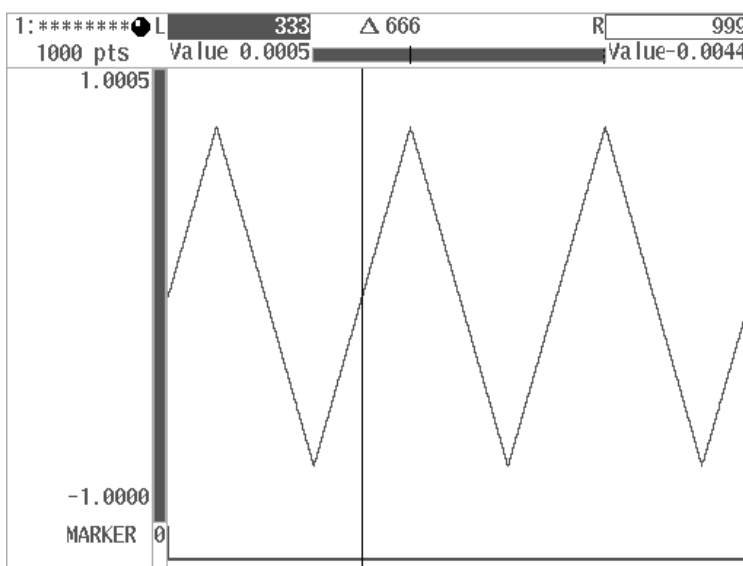

Figure 4A-40: Defining the Location for Insertion

The other waveform is inserted right before the active vertical bar cursor. However, when the cursor is at the end of the waveform, the data is inserted directly after the cursor.

- Step 3:** After setting the position to insert the other waveform, select **Insert Other Waveform** from the side menu. A list of waveform files is displayed.

Data placed into the paste buffer with **Cut** or **Copy** is listed at the top of the file list with the name "**Paste Buffer**." The data in the paste buffer can be inserted into any desired location by selecting this item.

- Step 4:** Use the general purpose knob to select the waveform file to be inserted from the file list.

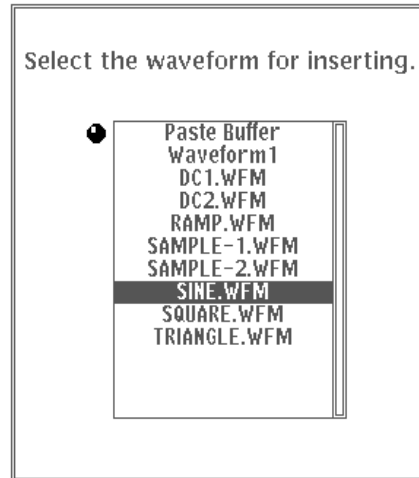

Figure 4A-41: List of Files for Insertion

- Step 5:** Select the **Show Catalog Entry** from the sub-menu. The waveform for the selected file is displayed.

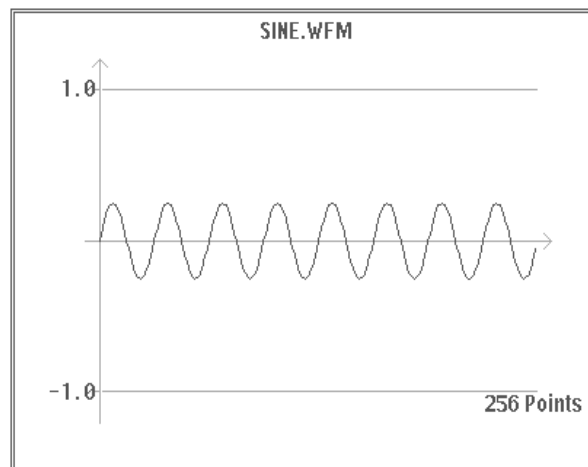

Figure 4A-42: File Waveform Display

- Step 6:** Select **O.K.** from the sub-menu.

The waveform from the selected file is inserted right before the active vertical bar cursor. Select **Cancel** to cancel the waveform insertion. When **O.K.** or **Cancel** is selected, the display returns to the menu displayed before **Insert Other Waveform** was selected.

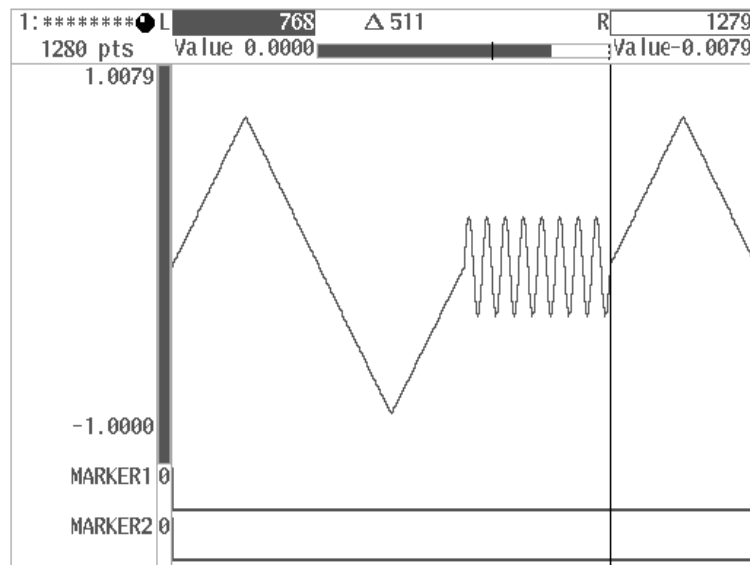

Figure 4A-43: Inserting Waveforms

Single
Waveform
Math...

Single Waveform Calculations

The **Single Waveform Math...** item allows you to perform mathematical calculations for the waveform itself. Calculations are applied to the portion of the waveform between the vertical bar cursors.

- **Absolute** Determines the absolute value for the amplitude
- **Square** Doubles the absolute value for the amplitude. If the amplitude is a negative number, the calculated result is also negative
- **Cube** Triples the amplitude
- **Square Root** Determines the square root for the absolute value of the amplitude. If the amplitude is a negative number, the calculated result is also negative.
- **Normalize** Normalizes the amplitude between -1.0 and $+1.0$.
- **Integral** Integrates the amplitude
- **Differential** Differentiates the amplitude

The following diagram shows the menu configuration for the **Single Waveform Math...** item.

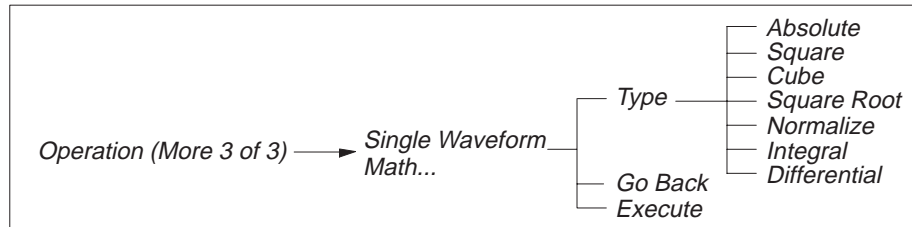

Procedure

To derive the **Absolute** value for the amplitude of a sine wave between the vertical bar cursors:

- Step 1:** Create the sine wave to be subjected to **Absolute** operation. Figure 4A-44 shows the sine wave before calculations are performed.

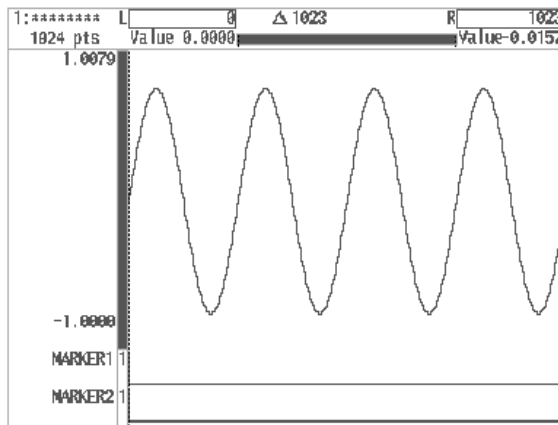

Figure 4A-44: Waveform Example before Calculation

- Step 2:** Press the **CURSOR** button on the front panel.
- Step 3:** Using the general purpose knob, move the left and right vertical bar cursors to define the area for calculation.
- Step 4:** Select **Single Waveform Math...** from the third page of the side menu (**More 3 of 3**).
- Step 5:** Press the **Type** button in the sub-menu and select **Absolute**.
- Step 6:** Select **Execute** from the sub-menu. The absolute value will be derived for the section of the waveform between the vertical bar cursors. Figure 4A-45 shows the waveform after calculation.

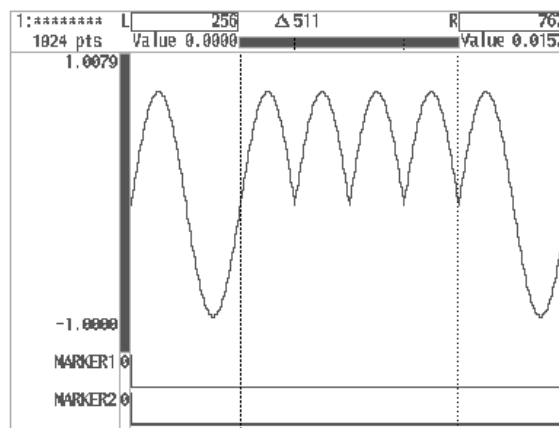
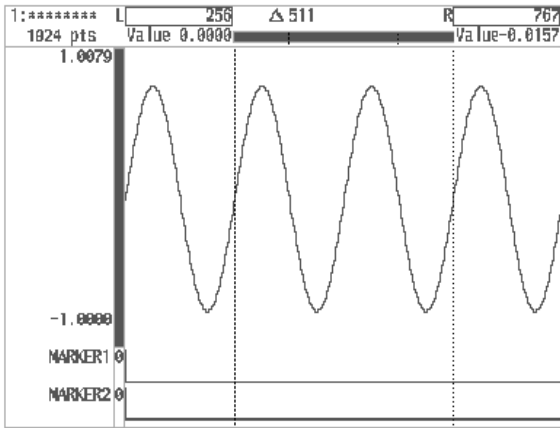

Figure 4A-45: Absolute Calculation

- Step 7:** Select **Go Back** from the sub-menu. The display returns from the **Single Waveform Math...** sub-menu to the side menu.

The following diagrams show examples of a waveform before and after various calculations are performed.

Square — Doubles the absolute value for the amplitude



Before

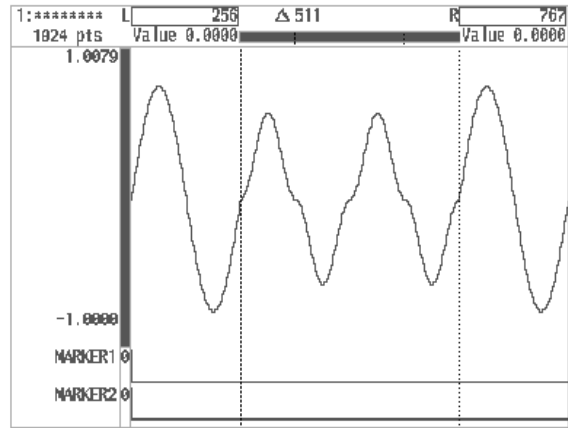

After

Figure 4A-46: Square Calculation

Cube — Triples the amplitude

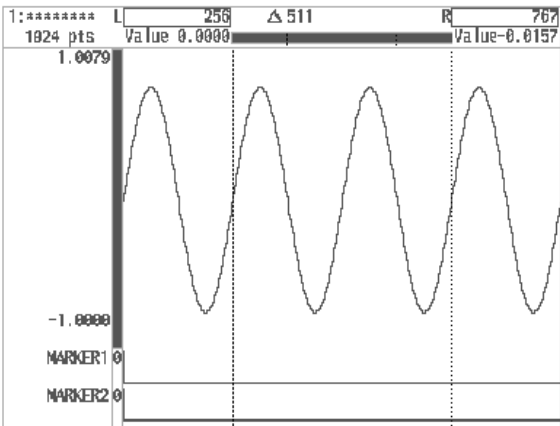

Before

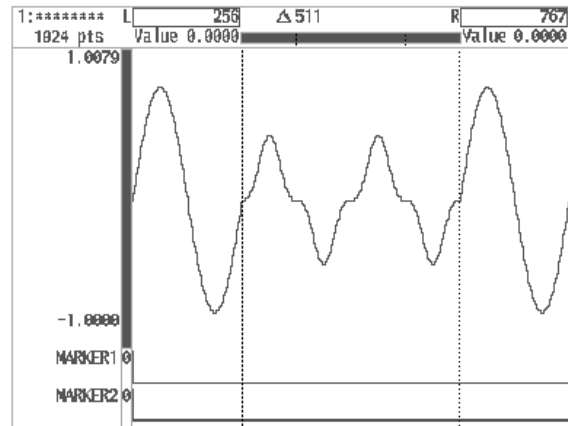

After

Figure 4A-47: Cube Calculation

Square Root — Determines the square root for the absolute value of the amplitude

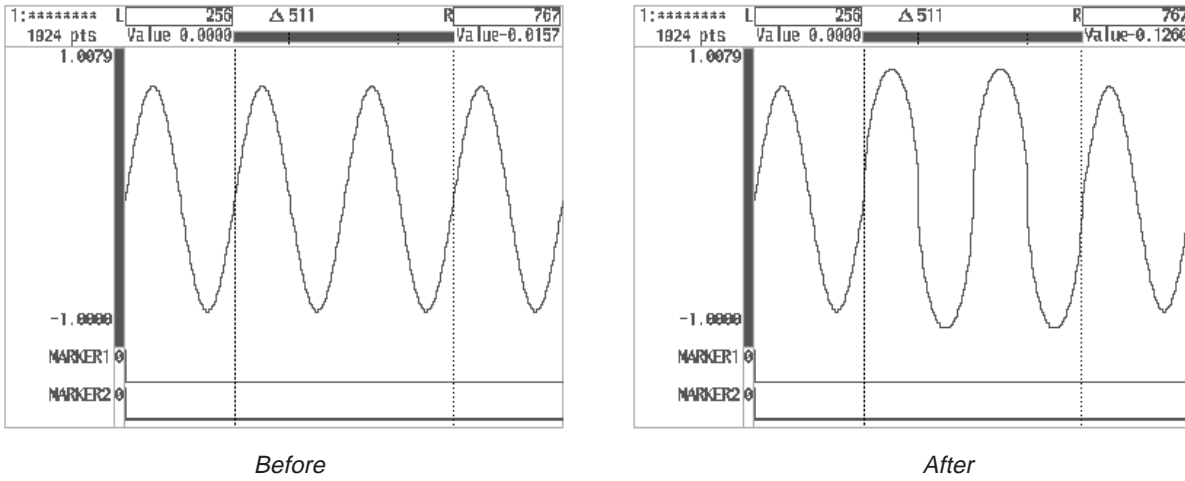

Figure 4A-48: Square Root Calculation

Normalize — Normalizes the amplitude

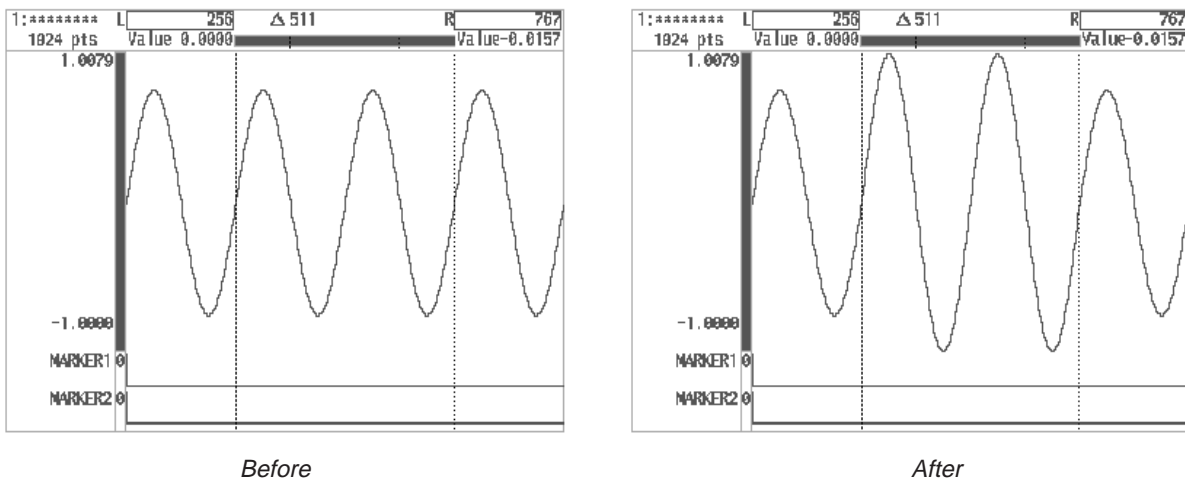

Figure 4A-49: Normalize Calculation

Integral — Integrating the amplitude

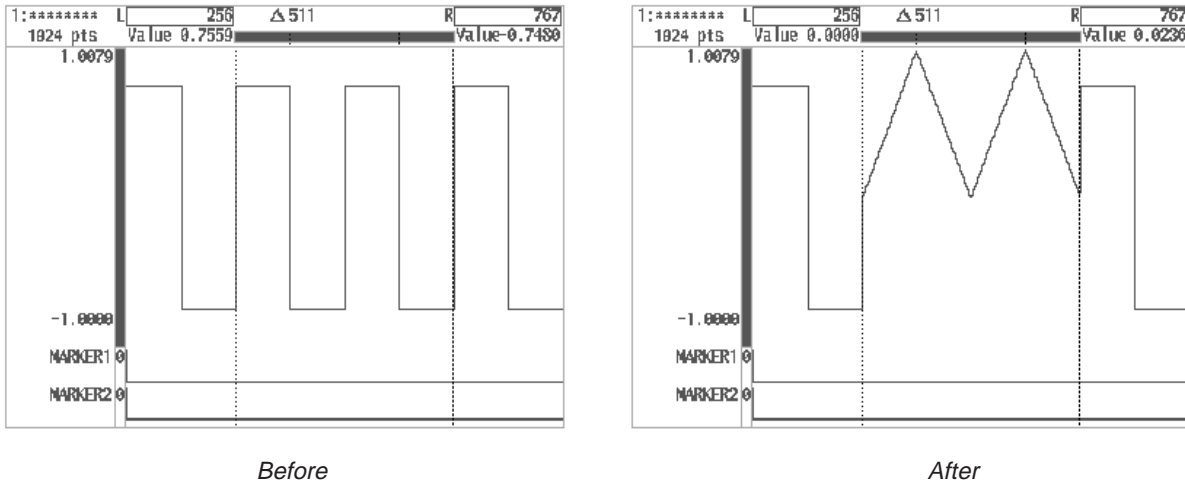

Figure 4A-50: Integral Calculation

Differential — Differentiating the amplitude

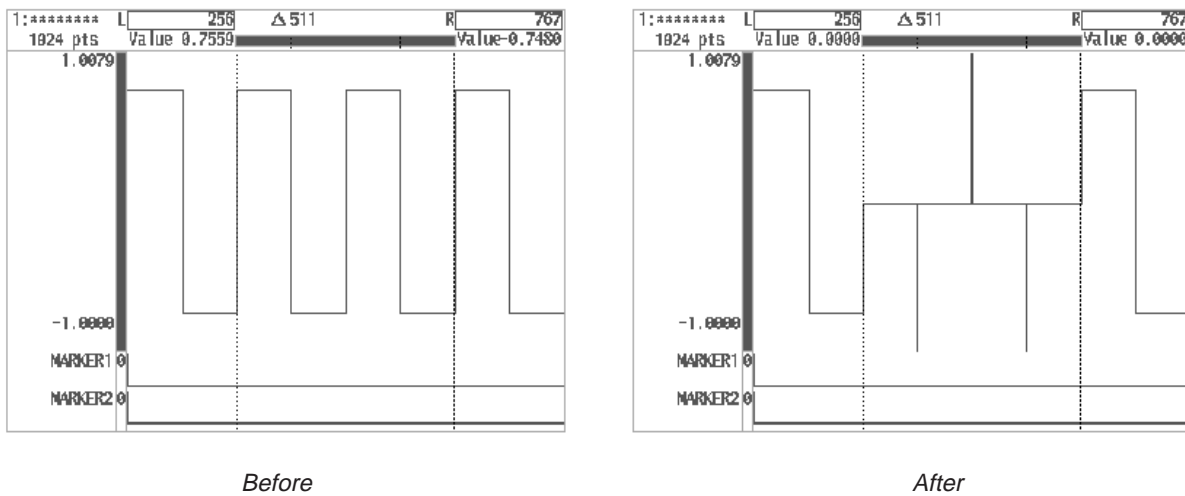

Figure 4A-51: Differential Calculation

Dual
Waveform
Math...

Calculations With Other Waveform Data

Use **Dual Waveform Math...** to perform math operations with the waveform currently being edited and other waveform data. The following calculations can be performed:

- **Add** Adds the waveform data being edited and the other waveform file data.
- **Sub** Subtracts the other waveform file data from the waveform data being edited.
- **Mul** Multiplies the waveform file data being edited by the other waveform file data.

The region pushed out beyond the vertical axis full scale by the calculations is clipped.

The following diagram shows the menu configuration for the **Dual Waveform Math...** item.

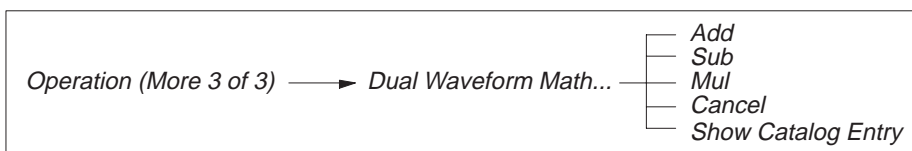

Procedure

- Step 1:** Create the waveform to be operated on with the other waveform file data. Figure 4A-52 shows the example of waveform before the arithmetic operations.

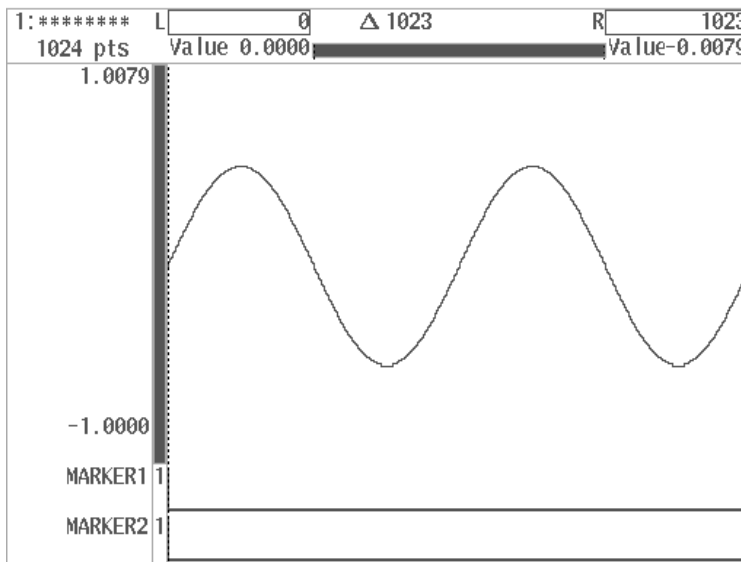

Figure 4A-52: Example of Waveform Before Arithmetic Operations

- Step 2:** Press the **CURSOR** button on the front panel.

- Step 3:** Using the general purpose knob, move the vertical bar cursors to define the area for calculation.
- Step 4:** Select **Dual Waveform Math...** from the third page of the side menu (**More 3 of 3**).
- Step 5:** A list of files will be displayed on the screen. Using the general purpose knob, select the file for which the calculations will be performed. Calculations will be executed for both the section of the waveform data being edited between the vertical bar cursors and the selected waveform file.

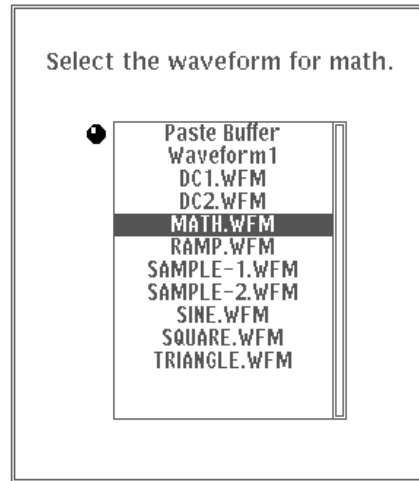

Figure 4A-53: List of Files for Waveform Calculation

- Step 6:** Select **Show Catalog Entry** from the sub-menu. The waveform for the selected file is displayed. See Figure 4A-54.

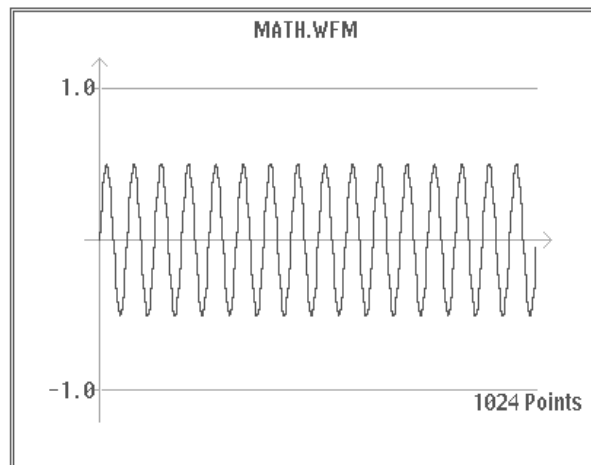

Figure 4A-54: Selected File Waveform Display

- Step 7:** After verifying the waveform, select **Continue** from the sub-menu. The waveform will disappear and the system returns to previous **Dual Waveform Math...** sub-menu.
- Step 8:** Select the desired calculation type from the sub-menu. The moment a calculation type is selected, the calculation is carried out and the results are displayed on the CRT screen. The display returns to the menu on display before **Dual Waveform Math...** was selected. Figure 4A-55 displays the waveforms added (**Add**) between the vertical bar cursors.

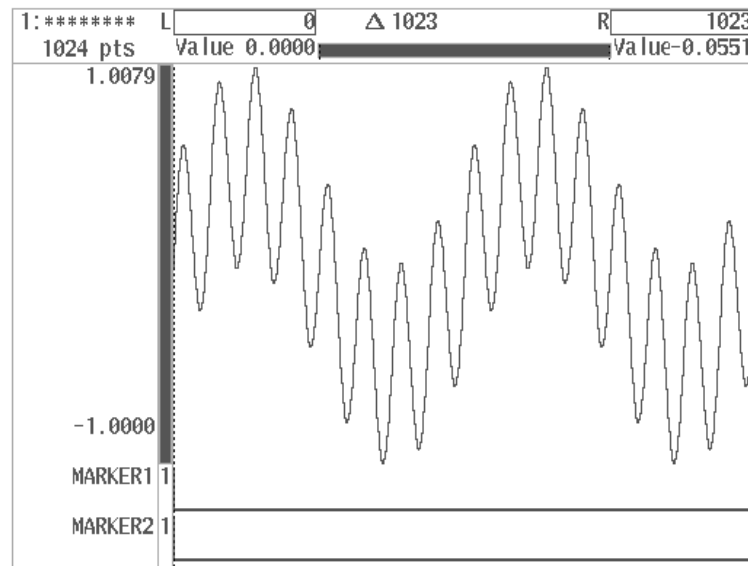

Figure 4A-55: Waveform Addition Display

If you select **Cancel**, the menu returns to the menu on display before **Dual Waveform Math...** was selected without any calculations being made.

Data placed into the paste buffer with **Cut** or **Copy** is listed at the top of the file list with the name "**Paste Buffer**." When this item is selected, an operation is carried out with the data in the paste buffer.



Specified Region Shift

The **Region Shift...** item shifts a user-specified region of a waveform in one of the following ways.

- Right or left
- Expand (out from the center)
- Compress (in toward the center)

If the specified amount of the shift is less than the sampling interval, the original waveform is resampled using data interpolation to derive the shifted values. The **Region Shift...** item has the following menu configuration.

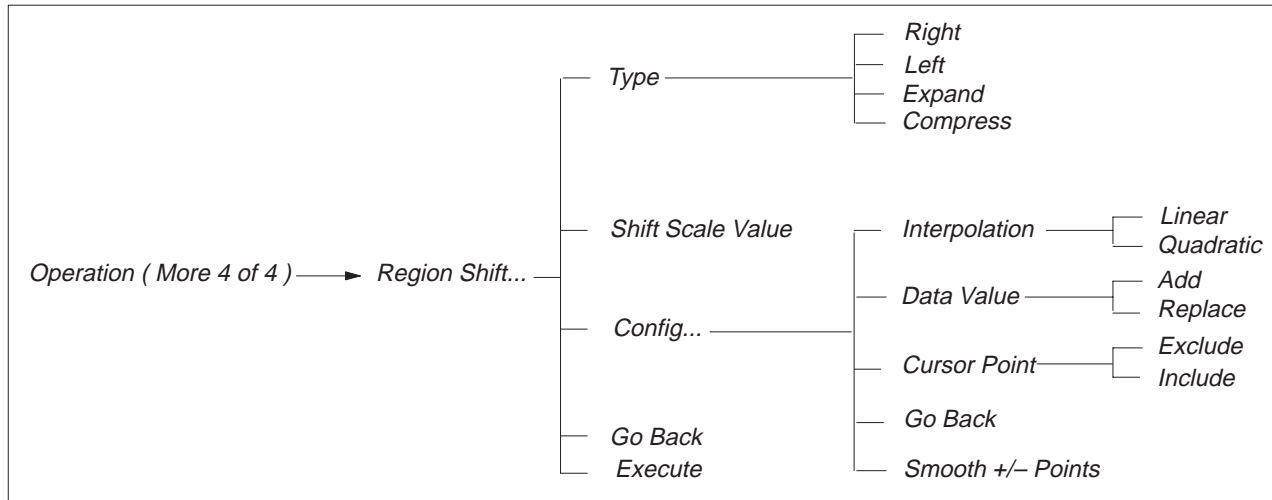

Table 4A-3 lists the differences between the **Specified Region Shift** function and the **Shift** function described on page 4A-51.

Table 4A-3: Differences Between the Shift Operations

Item	Shift	Region Shift
Area affected	Rotates the area inside the range delimited by the cursors	Shifts the area inside the range delimited by the cursors to a different area
Shift amount	Data point spacing	Amounts less than the data point spacing
Interpolation at intersection	None	Interpolation performed

Data changed by manipulations performed from the **Region Shift...** menu can be restored to the prior state (for one operation only) using the **Undo** item on the bottom menu. If the result of the operation was not what was intended, use the **Undo** function to restore the original data. You can obtain optimal settings for shift parameters using the **Undo** function. If the new shift parameters do not produce the desired results, use **Undo** to cancel the operation. Then enter new shift parameters and use **Undo** to cancel each operation until you achieve the desired results.

Shift Type Selection

There are four types of specified region shifts. The **Type** item selects which shift operation will be performed. **Right** or **Left** shifts the selected region to the right or left, respectively. **Expand** moves the data out from the center. **Compress** moves the data toward the center.

Type

Right or Left — Shifts the area delimited by the left and right vertical bar cursors the amount specified by the **Shift Scale Value** item. When the shift type is **Right** the data shifts to the right; when **Left** the data shifts left. In the example of Figure 4A-56 the shift type is **Right**. The original data shifts to the right by one sampling point (Data Shifted to Right by 1). The maximum value that you can specify for a right or left shift is the number of waveform data points. If a section of data is shifted beyond the maximum number of data points, the data contained in that section is lost after the shift.

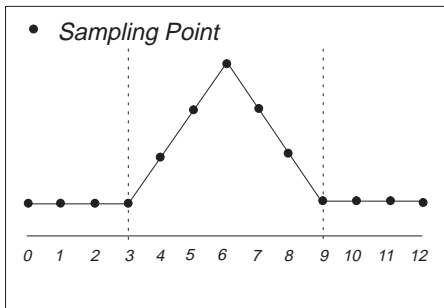

Original Data

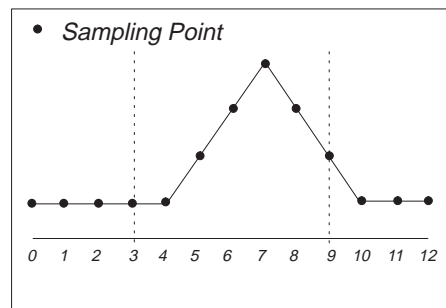

Data Shifted to Right by 1

Figure 4A-56: Data Shifted Using the "Right" Item

Expand or Compress — The area delimited by the left and right vertical bar cursors is divided into two adjacent regions located between the cursors. For the **Compress** shift type, the two regions shift toward the center point. For the **Expand** shift type, the two regions shift away from the center. The **Shift Scale Value** item determines the amount of shift for the **Compress** and **Expand** operations. In the example of Figure 4A-57 the shift type is **Compress**. The original data (left side of figure) is compressed as shown by the right example (Data Compressed by 1).

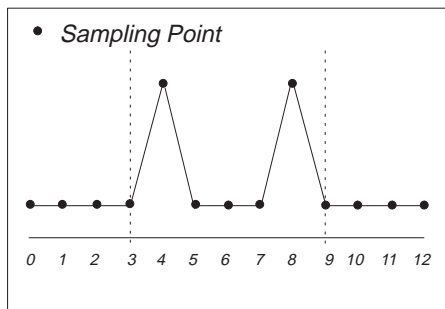

Original Data

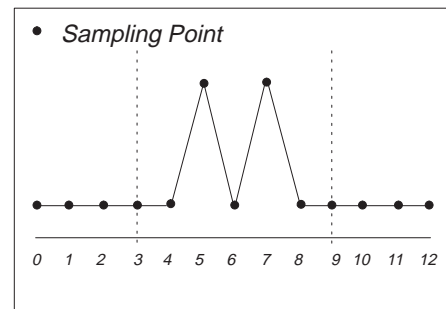

Data Compressed by 1

Figure 4A-57: Data Compressed Using the "Compress" Item

The Shift Values For Selecting Expand or Compress

Expand — The maximum value that you can specify for a shift is the number of waveform data points. If a section of data is shifted beyond the maximum number of data points, the data contained in that section is lost after the shift.

Compress — The value of the shift must be less than one-half the size of the area surrounded by the left and right vertical bar cursors. If the **Data Value** item (described on page 4A-79) is set to **Replace**, the section that exceeds the position of one-half the region is lost after the shift.

Shift
Scale Value

Shift Scale Value

When shifting waveform data, it is possible to specify a **Shift Scale Value** with a precision that exceeds that of the sampling points. In the AWG2041 arbitrary waveform generator, values may be specified with a resolution as fine as $1/1000$ point. However, it is not always possible to realize a shift of that precision due to the form of the waveform itself. Changes in the lowest digit of the shift value will not be reflected in the output unless the amplitude of the original waveform spans the full scale of the data representation.

NOTE. *Since data values between the data points are calculated by interpolation when shifting by a fractional value, certain characteristics of the original waveform may be lost. Therefore, a filter must be inserted to prevent aliasing.*

If the changes in the waveform are extremely smooth, fractional shift amounts may not result in the intended effect.

Procedure

- Step 1:** Specify the region to be shifted with the left and right vertical bar cursors, and select the **Region Shift...** item on the fourth page of the side menu (**More 4 of 4**).
- Step 2:** Select the shift type by pressing the sub menu **Type** button.
- Step 3:** Select **Shift Scale Value** from the sub menu.
- Step 4:** Enter the shift amount using either the general purpose knob or the numeric keys. The shift value can also be displayed as a time value.
- Step 5:** If other settings related to the shift need to be specified, select the **Config...** item from the sub menu. See the "Other Shift Settings" item on page 4A-77 for more information.
- Step 6:** Select **Execute** from the sub menu. The waveform in the edit region will be shifted with the specified conditions.

Config...

Other Shift Settings

The following parameters can be set from the **Config...** item.

Interpolation	Selecting the interpolation method
Data Value	Handling of overlapping regions in the shift result
Cursor Point	Interpolation of the data on the cursors
Smooth +/- Points	Setting the smoothing width at the data boundary positions

Interpolation

Interpolation

The data is resampled when shifting by fractional amounts. Data values between data points are acquired by interpolation. The **Interpolation** item selects the interpolation method used. The following options are provided.

- **Linear** interpolation is appropriate if the original waveform consists of straight lines, such as triangle or square waves. However, the peaks in waveforms with extremely sharp peaks may be slightly flattened.
- **Quadratic** interpolation is appropriate for waveforms with curves, such as sine waves. However, in waveforms with extremely sharp peaks, some peaks may become wider.

Linear Interpolation — Figure 4A-58 provides an example of linear interpolation. If the point X_2 is shifted to the left by 0.2, the new value is calculated by interpolating with the next point to the left.

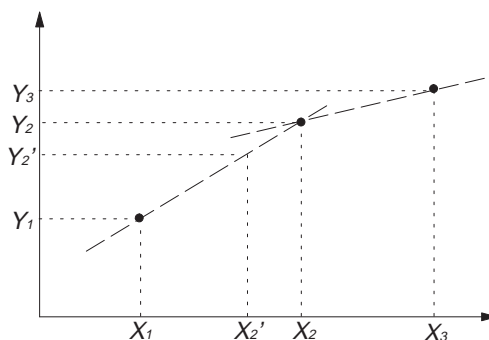

Figure 4A-58: Linear Interpolation

If the coordinate of the shifted point is X_2' , then the value of point Y_2' is given by the following formula.

$$Y_2' = 0.2 \times Y_1 + (1-0.2) \times Y_2$$

Quadratic Interpolation — Figure 4A-59 provides an example of quadratic interpolation. If point X_2 is shifted to the left by 0.2, the new value is calculated by interpolation using three points: the shifted point, the point preceding the shifted point, and the point following the shifted point.

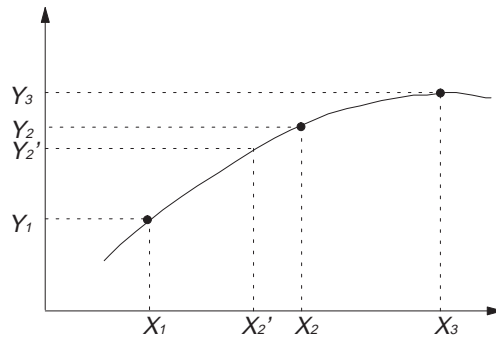

Figure 4A-59: Quadratic Interpolation

Quadratic interpolation is expressed as follows.

$$f(x) = Ax^2 + Bx + C$$

The coefficients A , B , and C in the above formula are derived using the three points including those directly preceding and following the position to be derived.

$$y_1 = Ax_1^2 + Bx_1 + C$$

$$y_2 = Ax_2^2 + Bx_2 + C$$

$$y_3 = Ax_3^2 + Bx_3 + C$$

Simplifying by letting $x_1 = -1$, $x_2 = 0$, $x_3 = 1$, gives:

$$y_1 = A - B + C$$

$$y_2 = C$$

$$y_3 = A + B + C$$

This allows the coefficients A , B , and C to be derived as follows:

$$A = \frac{y_1 + y_3}{2} - y_2$$

$$B = \frac{y_3 - y_1}{2}$$

$$C = y_2$$

Using these values, the value y_2' at position x_2' can be derived as follows.

$$y_2' = \left(\frac{y_1 + y_3}{2} - y_2\right) \times (-0.2)^2 + \left(\frac{y_3 - y_1}{2}\right) \times (-0.2) + y_2$$

Data Value
Add
Replace

Data Value

This item selects how overlapping regions in the shift result are handled.

- **Add** — Adds the shifted data and the overlapping data.
- **Replace** — Replaces the region with the shifted data. When **Type** is **Compress**, the data for points shifted beyond the center are lost.

Cursor Point
Exclude
Include

Cursor Point

This item selects whether the data boundary points are interpolated. The selections are **Exclude** and **Include**.

When the **Cursor Point** is **Exclude**, the points on the left and right vertical bar cursors are not interpolated. Figure 4A-60 shows how the original data will appear when **Exclude** is selected following a shift to the right. In this example, the first and last data points remain at their original values. You can minimize this error by inserting an appropriate anti-aliasing filter.

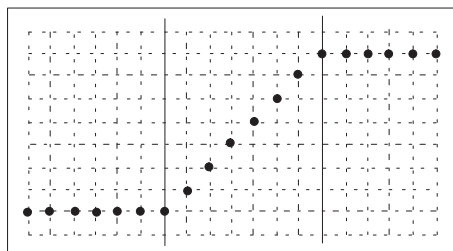

Original Data

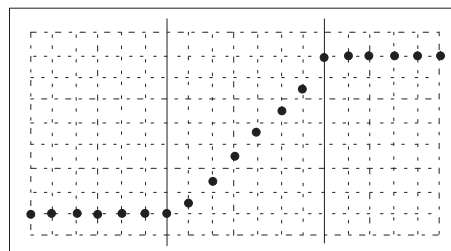

Data Shifted to Right by 0.5

Figure 4A-60: Shift with "Cursor Point" Set to "Exclude"

When the **Cursor Point** is **Include**, the points on the left and right vertical bar cursors are interpolated.

Smooth
+/- Points

Smooth +/- Points

This item specifies the smoothing width with points at the data boundary positions. Smoothing is only performed over the points specified for the area around the boundary positions. No smoothing is performed if this point is set to zero. Points can be set within the range 0 through 20.

Smoothing is performed on a specified region without regard for the shift. The smoothing technique used takes the average of the point itself and the two adjacent points (three points) as the new value of the point. Smoothing is performed over regions centered on the end points of the pre-shift region and the post-shift region, respectively, and is extended in both directions by the smoothing points.

Figure 4A-61 shows an example of smoothing. The original data appears on the left and the smoothed data is on the right.

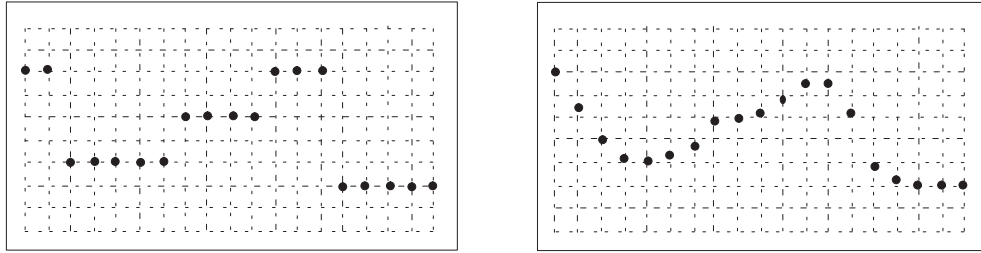

Before Smoothing

After Smoothing

Figure 4A-61: Smoothing

NOTE. Since smoothing is equivalent to low pass filtering, features of the original waveform can be lost resulting in significant changes to the waveform. To acquire appropriate output waveforms, experiment with a variety of values for the **Smooth +/- Points** parameter.

Side Effects from Shifting

The left side of Figure 4A-62 shows data before shifting. The right side of the figure shows the result of shifting the data between the cursors (solid vertical lines) by 0.5 units to the right. In the example of Figure 4A-62, the data location must be determined 0.5 units to the left of each point in order to achieve the 0.5 unit shift to the right. **Linear** interpolation is used in this example to determine the data location.

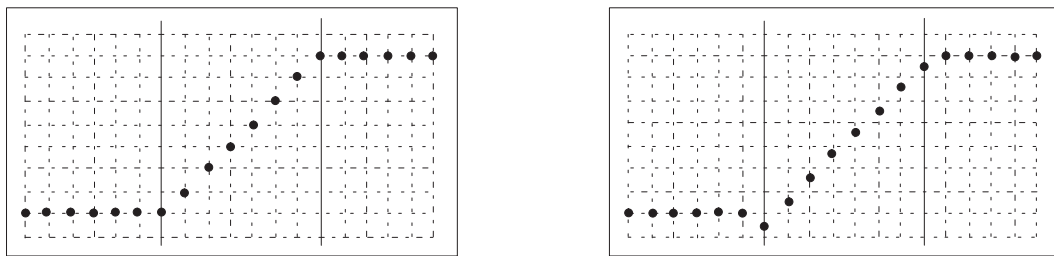

Original Data

Data Shifted to Right by 0.5

Figure 4A-62: Data Shifting

When the resulting data is output through an appropriate filter, the waveform will be shifted to the right by 0.5 units. After the shift operation is completed, the data point at the position of the left cursor is lowered. This is a side effect of the interpolation process. Following are several ways that you can prevent this data lowering phenomenon.

- Increase the size of the area
- Set the **Cursor Point** setting to **Exclude**
- Apply smoothing (there are waveforms for which smoothing may not be effective)

Increasing the Size of the Area

Data that is identical across the operation can be acquired by increasing the size of the area (Figure 4A-63). Smooth data is acquired when this area is shifted, as shown by the right example of Figure 4A-63.

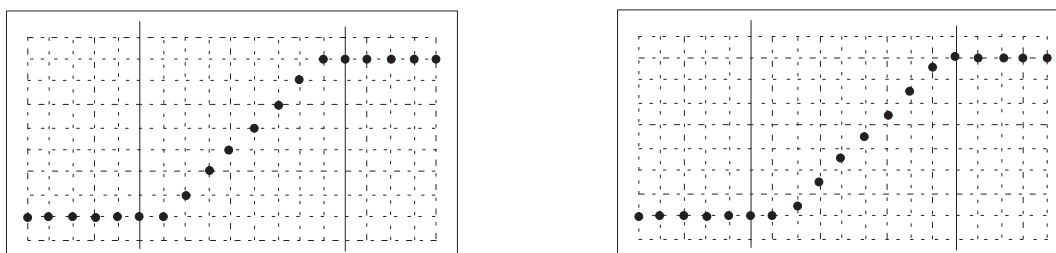

Original Data

Data Shifted by 0.5 to Right

Figure 4A-63: Increasing the Size of the Area

The smooth data results when using linear interpolation because the value of the data does not change when interpolating between points with the same value. An unchanged data value is the same as not performing a shift. However, you can minimize this error by inserting an appropriate anti-aliasing filter.



Multiple Copy

The **Multiple Copy...** item appears in the menu when two or more waveforms are being edited simultaneously. It is used to copy the section of the waveform between the two vertical bar cursors in one editing area to the waveform between the vertical bar cursors in another editing area, at the interval specified with **Interval**. The following diagram shows the menu configuration for the **Multiple Copy...** item.

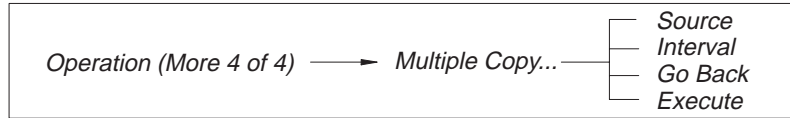

See "Opening and Selecting Editing Areas" on page 4A-16 for further information on designating multiple editing areas.

Procedure

In this example, we will copy the waveform between the vertical bar cursors in editing area 1 to editing area 2. We will start from the point at which only one waveform has been designated in the waveform editor.

To designate a second waveform in the waveform editor:

- Step 1:** Choose **Select/Open** from the bottom menu.
- Step 2:** Select **Another Waveform** from the side menu.
- Step 3:** Using the general purpose knob, select **New Waveform** from the waveform list and then select **O.K.** A second editing area will appear, as shown in Figure 4A-64.

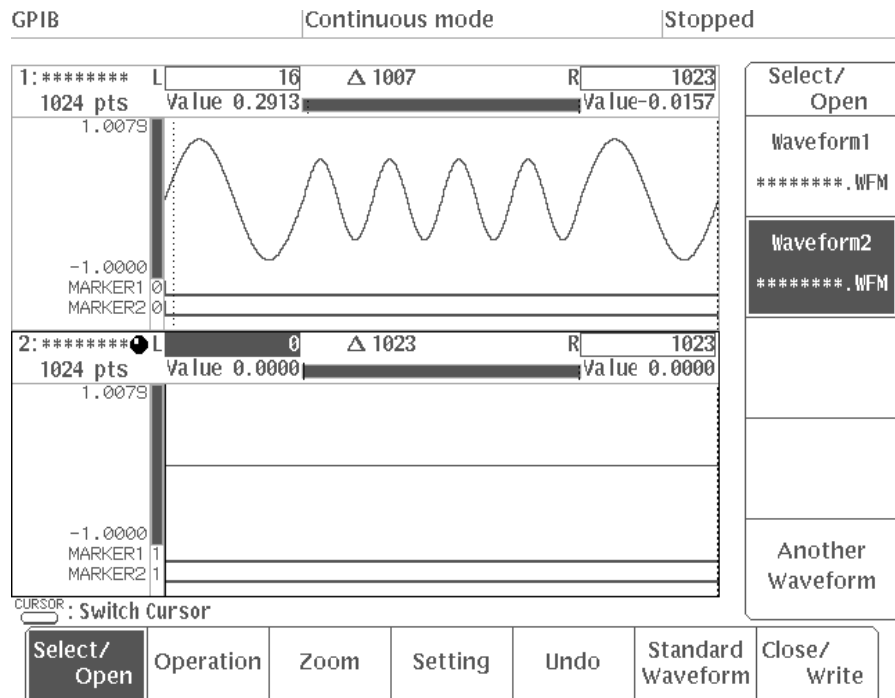

Figure 4A-64: Two Waveform Editing Areas Designated

To select the area for waveform copying:

- Step 4:** Select **Waveform1** from the side menu to designate this waveform area as the source for copying.
- Step 5:** Press the **CURSOR** button on the front panel.
- Step 6:** Using the numeric keys or the general purpose knob, move the vertical bar cursors to designate the section of the waveform to be copied. In this example, we will set the left cursor to point 256 and the right cursor to point 767.

NOTE. Copying will include the point at which the cursor is located. The value indicated by Δ at the top of the waveform area indicates the difference of number of points between the two cursors, so the number of points that will be copied will be this value plus one point.

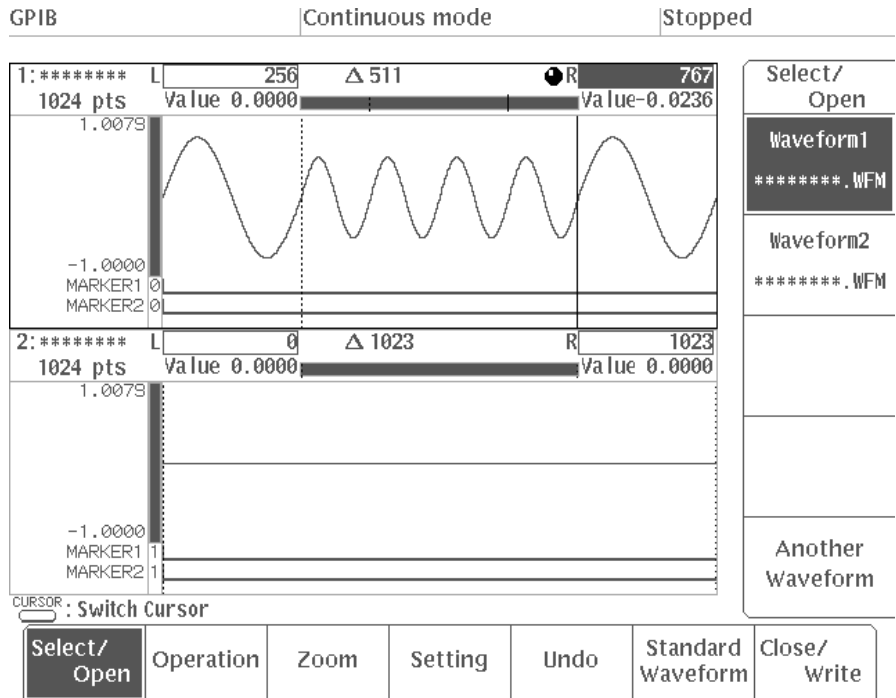

Figure 4A-65: Setting the Copy Source

Setting the Destination for Waveform Copying

- Step 7:** Select **Waveform2** from the side menu to designate this area as the destination for copying (the area to which the waveform will be copied).
- Step 8:** Press the **CURSOR** button on the front panel.
- Step 9:** Using the numeric keys or the general purpose knob, move the vertical bar cursors to set the area within which the waveform will be copied. In this example, we will set the left cursor to point 0 and the right cursor to point 1023.

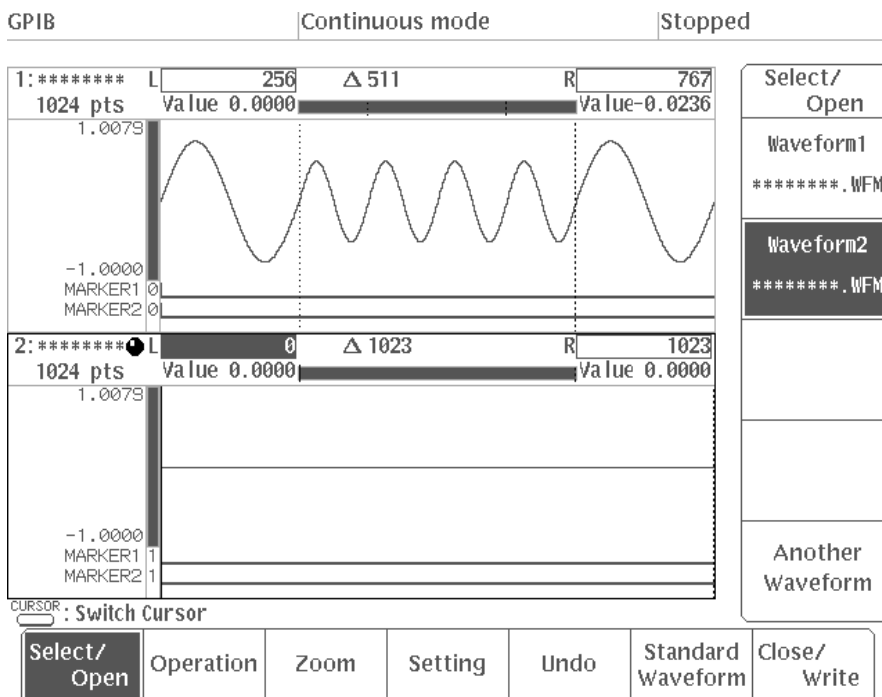

Figure 4A-66: Setting the Copy Destination

To copy the waveform:

- Step 10:** Select **Operation** from the bottom menu.
- Step 11:** Select **Multiple Copy...** from the fourth page of the side menu (**More 4 of 4**).

When three waveform areas have been designated in the waveform editor, select one of the remaining two editing areas as the source for waveform copying with **Source** item in the sub-menu.

- Step 12:** Select **Interval** from the sub-menu.
- Step 13:** Using the numeric keys, set the interval value to 512 points.

When copying the section of a waveform between the vertical bar cursors in one editing area to the area between the vertical bar cursors in another editing area, the **Interval** value determines the interval at which the waveform will be repeated horizontally (in points).

- Step 14:** Select **Execute** from the sub-menu.

If the number of points in the waveform between the vertical bar cursors in the copy source is the same as the value set for **Interval**, the copied waveform will be displayed repeating at the interval designated with **Interval**. In the example shown in Figure 4A-67, both the waveform point size and the **Interval** value are set to 512.

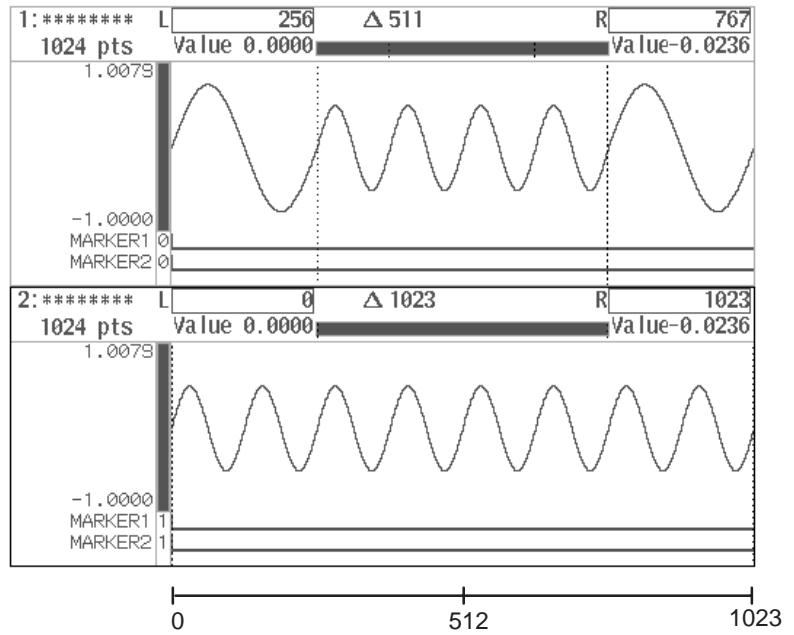

**Figure 4A-67: Waveform Copying
(number of points in waveform = Interval value)**

If the number of points in the waveform between the vertical bar cursors in the copy source is less than the value set for **Interval**, data at level 0 (in other words, a straight line) will be added at the end of the waveform. Figure 4A-68 shows an example in which the waveform point size has been set to 512 and the **Interval** has been set to 640. Data at level 0 has been added from point 512 to point 639; the next waveform begins from point 640.

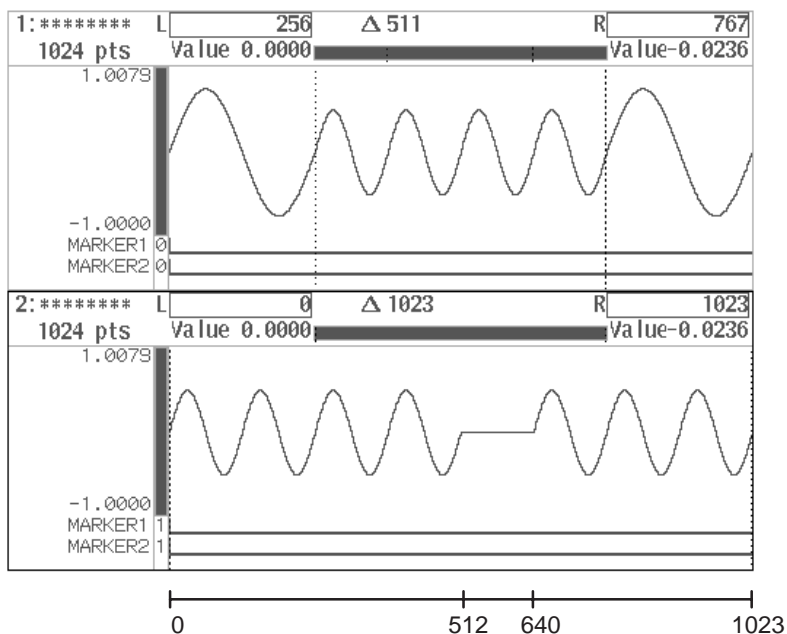

**Figure 4A-68: Waveform Copying
(number of points in waveform < Interval value)**

If the number of points in the waveform between the vertical bar cursors in the copy source is greater than the value set for **Interval**, the overlapping portion will be added to the waveform. Figure 4A-69 shows an example in which the waveform point size has been set to 512 and the **Interval** value has been set to 384. The copied waveform will be pasted at intervals of 384, starting from points 0, 384 and 768 and so the waveform will overlap in phase between points 384 – 511 and 768 – 895. As a result, the amplitude in these areas will be doubled.

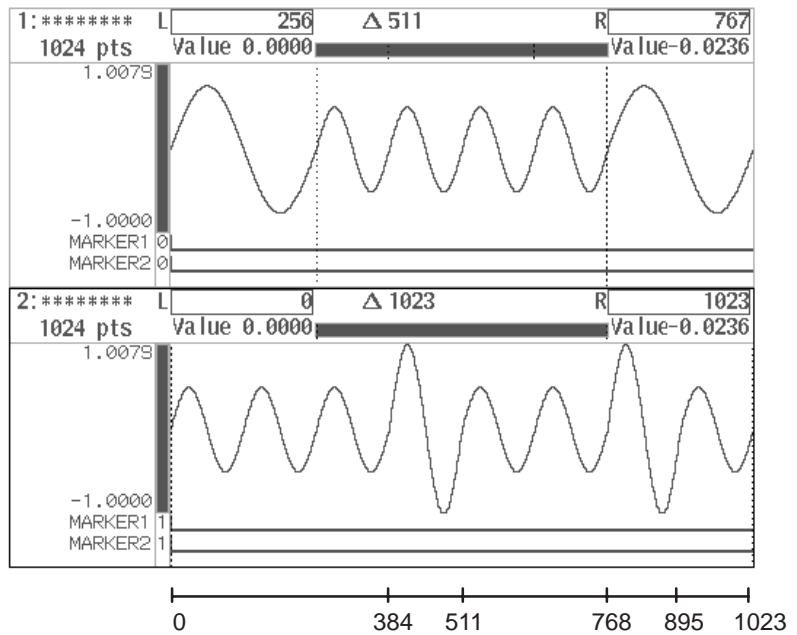

**Figure 4A-69: Waveform Copying
(number of points in waveform > Interval value)**

- Step 15:** Select **Go Back** from the current sub-menu. The display moves from the **Multiple Copy...** sub-menu to the side menu.

Convolute...

Convolution Calculations

The **Convolute...** menu item appears when two or more waveforms are being edited. It is used to convolute the section of the waveform between the two vertical bar cursors in one editing area with the waveform between the vertical bar cursors in another editing area. The result is normalized. The following diagram shows the menu configuration for the **Convolute...** item.



See "Opening and Selecting Editing Areas" on page 4A-16 for further information on designating multiple editing areas.

On a discrete system, convolution is called discrete convolution. The convolution $y(n)$ of waveform $x(n)$ and waveform $h(i)$ can be expressed by the following formula, where N is the number of data items:

$$y(n) = \sum_{i=0}^{N-1} x(i)h(n-i)$$

The operation expressed by this formula is called convolution.

Procedure

With the waveform between the vertical bar cursors in editing area 1 as the **Source**, in this example we will perform convolution between this waveform and the one in editing area 2. In this example, a Gaussian pulse of 640 points is used for **Waveform1**, while a magnetic disc waveform of 640 points is used for **Waveform2**. The procedure begins from the point where both waveforms have been designated for the editing area. The Gaussian pulse waveform is included on the sample waveform library disk that came with the instrument.

Setting the convolution range

- Step 1:** Select **Select/Open** from the bottom menu.
- Step 2:** Select **Waveform1** from the side menu.
- Step 3:** Press the **CURS** button on the front panel.
- Step 4:** Using the numeric keys or the general purpose knob, set the positions of the left and right vertical bar cursors to define the section of the waveform for convolution. In this example, we will set the left cursor to point 0 and the right cursor to point 639.

- Step 5:** Select **Waveform2** from the side menu.
 - Step 6:** Select **Setting** from the bottom menu.
 - Step 7:** Select **Waveform Points** from the side menu and, using the numeric keys or the general purpose knob, set the waveform point size to 1280.
- 640 points is sufficient for the range of calculation for **Waveform2**; in order to display all of the results of calculation, the **Waveform2** editing area (where the results will be displayed) must be enlarged. The area needed is the sum of the point sizes for the two waveforms.
- Step 8:** Press the **CURSOR** button on the front panel.
 - Step 9:** Using the numeric keys or the general purpose knob, set the positions of the left and right vertical bar cursors to define the section of the waveform for convolution. In this example, we will set the left cursor to point 0 and the right cursor to point 1279. Figure 4A-70 shows the two editing areas with the vertical bar cursors in each area marking the section of the waveform to be used for convolution.

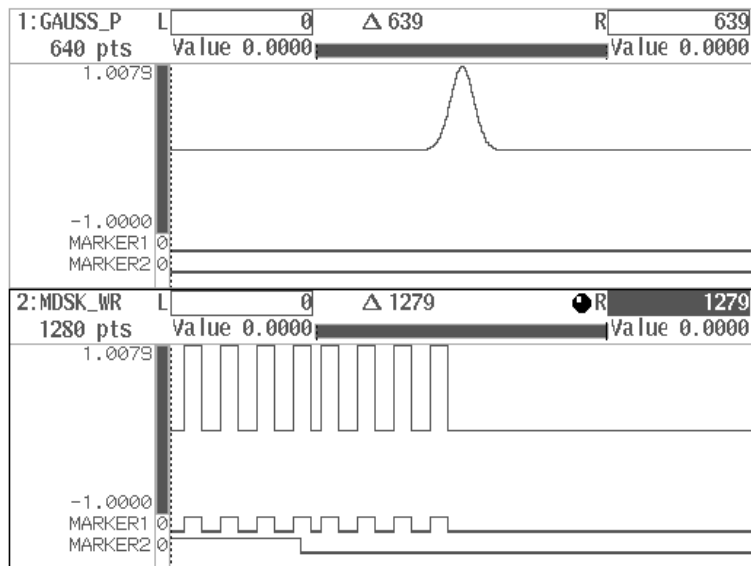

Figure 4A-70: Setting the Area for Convolution

Calculating the waveforms

- Step 10:** Select **Operation** from the bottom menu.
- Step 11:** Select **Convolute...** from the fourth page of the side menu (**More 4 of 4**).

When three waveform areas have been designated in the waveform editor, select one of the other two editing areas as the source for waveform convolution with **Source** item in the sub-menu.

- Step 12:** Select **Execute** from the sub-menu. Figure 4A-71 shows the screen before and after convolution.

In this example, the results of calculation will be displayed between the left and right vertical bar cursors in editing area 2 (the one enclosed by a box on the screen) where editing is being performed. The convolution process will take approximately 60 seconds.

NOTE. The convolution process will take around 80 seconds for two waveforms consisting of 1024 points each; the time will vary slightly depending on the type of waveform. An instrument with Option 09 installed is equipped with the convolution waveform editor which performs convolution at high speed.

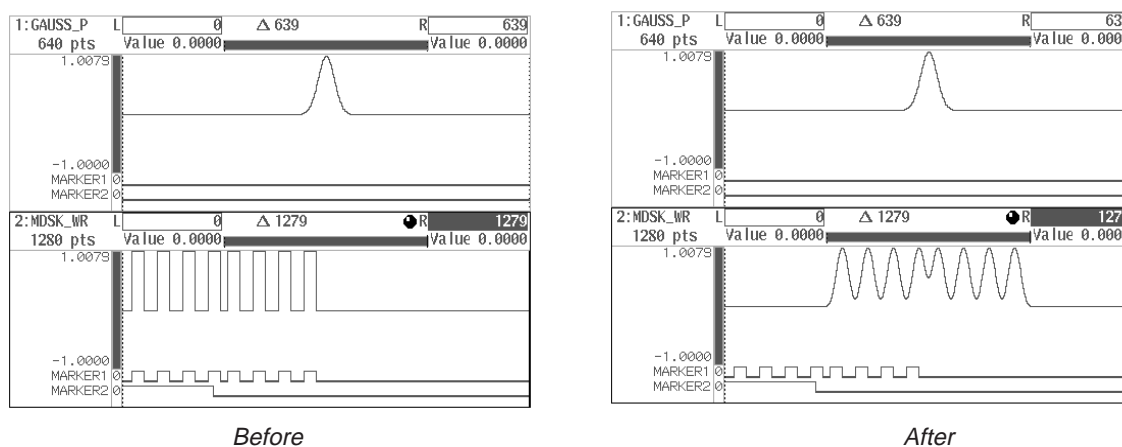

Figure 4A-71: Convolution

- Step 13:** Select **Go Back** from the current sub-menu. The display moves from the **Convolute...** sub-menu to the side menu.

Compare...

Comparing Waveforms

The **Compare...** item appears when two or more waveforms are being edited simultaneously. It is used to compare the section of the waveform between the two vertical bar cursors in one editing area to the waveform between the vertical bar cursors in another editing area. The following diagram shows the menu configuration for the **Compare...** item.

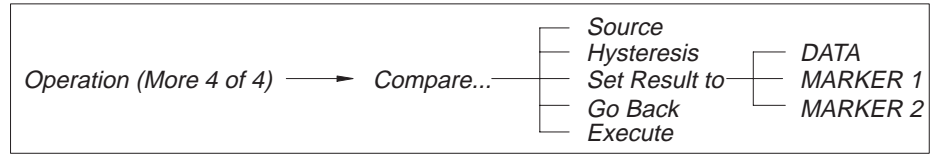

See "Opening and Selecting Editing Areas" on page 4A-16 for more detailed information regarding how to designate multiple editing areas.

Depending on whether the result of comparison is displayed in the editing area or in the **MARKER** area (as determined by the **Set Result to** item), the results are displayed as follows:

DATA selected in Set Result to

Comparison (data value)	Result (waveform level)
Destination > Source	1.000 (FFE in hexadecimal format)
Destination ≤ Source	0.000 (7FF in hexadecimal format)

MARKER selected in Set Result to

Comparison (data value)	Result (MARKER)
Destination > Source	1
Destination ≤ Source	0

Procedure

In this example, we will designate the portion of the waveform between the vertical bar cursors in editing area 1 as the reference (**Source**) and then compare it with the waveform between the vertical bar cursors in editing area 2. The procedure begins from the point at which two waveforms have been selected in the waveform editor.

Designating the Section for Comparison

- Step 1:** Select **Select/Open** from the bottom menu.
- Step 2:** Select **Waveform1** from the side menu. This waveform will be the reference for comparison.
- Step 3:** Press the **CURS** button on the front panel.

- Step 4:** Using the numeric keys or the general purpose knob, set the positions of the left and right vertical bar cursors to define the section of the waveform for comparison. In this example, we will set the left cursor to point 128 and the right cursor to point 639.

NOTE. The value indicated by Δ shows the difference in points between the left and right vertical bar cursors. This value includes the point occupied by the cursor, so the number of points in the waveform is $\Delta + 1$.

- Step 5:** Select **Waveform2** from the side menu. This waveform will be compared to the reference waveform.
- Step 6:** Press the **CURS** button on the front panel.
- Step 7:** Using the numeric keys or the general purpose knob, set the positions of the left and right vertical bar cursors to define the section of the waveform for comparison. In this example, we will set the left cursor to point 128 and the right cursor to point 895.
- Step 8:** Select **Operation** from the bottom menu.
- Step 9:** Select **Compare...** from the fourth page of the side menu (**More 4 of 4**). Figure 4A-72 shows the menu with the **Compare...** item selected.

When three waveform areas have been designated in the waveform editor, select one of the remaining two editing areas as the source for waveform comparison with **Source** item in the sub-menu.

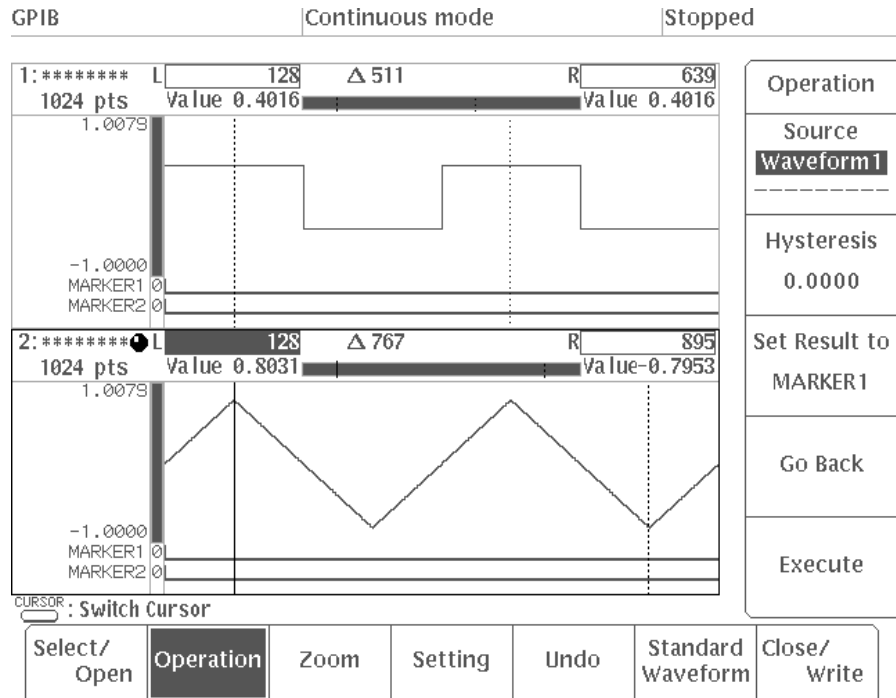

Figure 4A-72: Menu Display When Compare... is Selected

- Step 10:** Select **Set Result to** from the sub-menu and keep pressing this button until **MARKER** is selected.

This item is used to select where the results of comparison will be displayed.

- Step 11:** If you would like to apply hysteresis to the reference waveform, select **Hysteresis** and enter a value. If hysteresis is not necessary, this item should be set to 0.

Hysteresis comparison uses a higher and lower signal level than the **Source** signal level; the degree is determined by the value set with the **Hysteresis** item.

- Step 12:** Select **Execute** from the sub-menu.

Comparison Without Hysteresis

The left part of Figure 4A-73 shows a comparison of a triangular wave for **Waveform2** and a square wave for **Waveform1**, with the results output to the **Waveform2 MARKER** display area. The figure on the right has been provided as an aid to understanding this process.

Comparison is only performed for the section of **Waveform2** between the vertical bar cursors (in other words, from point 128 to point 895). Data outside this range is preserved as it was before comparison. The figure on the right shows the default marker set at point 0 remains "1."

As there is less data in the **Source** waveform than the destination waveform, data at level 0 (in other words, a straight line) has been automatically added from point 640 to point 895 in the **Source** waveform.

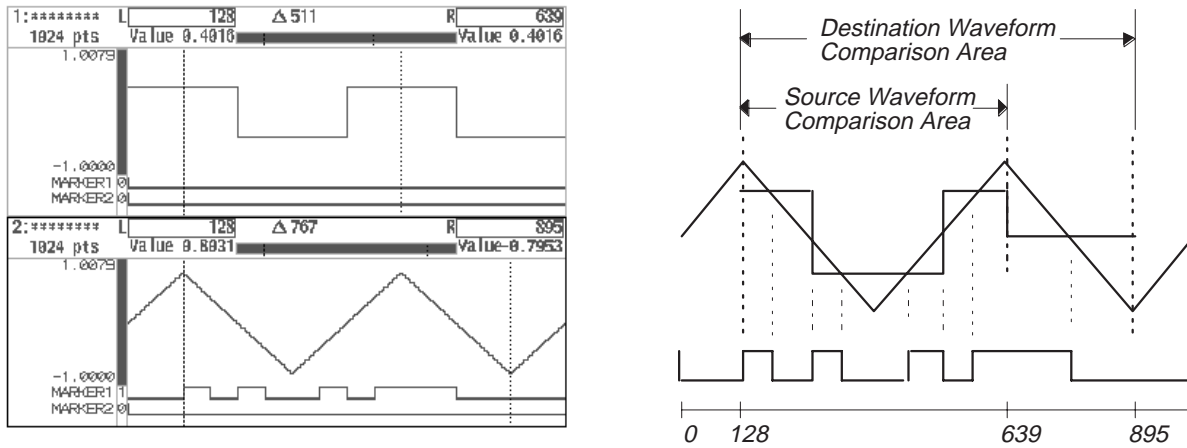

Figure 4A-73: Comparison Without Hysteresis

Comparison With Hysteresis

The left part of Figure 4A-74 shows a hysteresis comparison between a triangular wave as **Waveform2** and a square wave as **Waveform1**, with the results output to the **MARKER** display area in the **Waveform2** area. The figure on the right has been provided as an aid to understanding this process.

In hysteresis comparison, the waveform only becomes high level when the destination waveform exceeds the level above the **Source** waveform set for **Hysteresis**. The waveform only becomes low level when the destination waveform exceeds the level below the **Source** waveform set for **Hysteresis**.

Comparison is only performed for the section of the Waveform2 between the vertical bar cursors (in this example, from point 0 to point 1023).

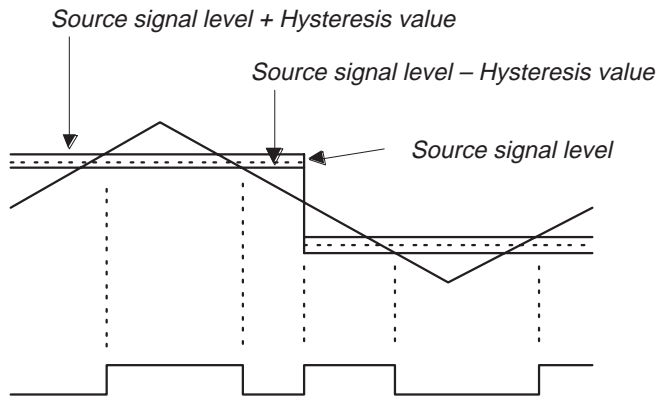
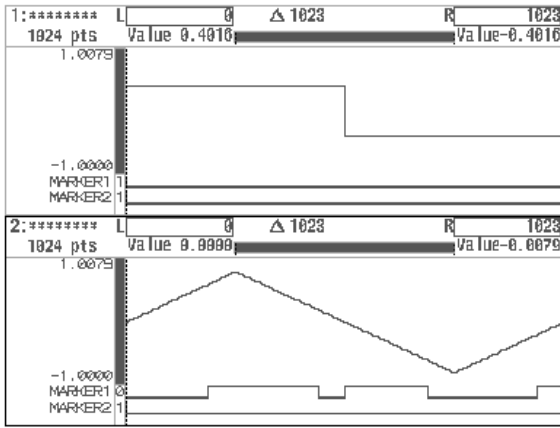

Figure 4A-74: Comparison With Hysteresis

- Step 13:** Select **Go Back** from the current sub-menu. The display moves from the **Compare...** sub-menu to the side menu.

Zooming Waveforms

Zoom

The **Zoom** item is used to enlarge or reduce the waveform being displayed, either horizontally or vertically. This process is for display purposes only; it does not affect the waveform data. The side menu consists of 2 pages: the first page contains the horizontal zoom items and the second page contains the vertical zoom items.

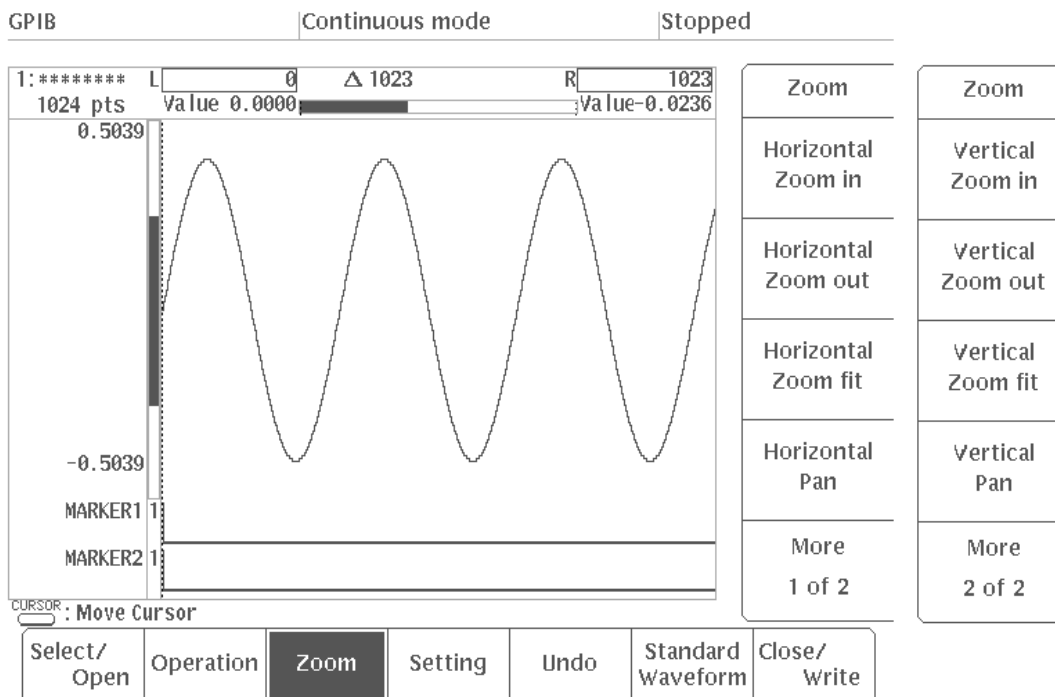

Figure 4A-75: Zoom Menu

Horizontal Zooming

Horizontal Zoom in

When the waveform is enlarged horizontally using the **Horizontal Zoom in** item, three additional items are displayed in the side menu:

- **Horizontal Zoom out** Used to reduce the waveform
- **Horizontal Zoom fit** Used to return to normal waveform size (x1)
- **Horizontal Pan** Used to scroll through the waveform when it is enlarged

Procedure

- Step 1:** Select **Zoom** from the bottom menu.
- Step 2:** Press the **CURSOR** button on the front panel.

- Step 3:** Using the general purpose knob, move the active vertical bar cursor to the center of the position at which you want the waveform to be displayed.

Horizontal waveform enlargement will be centered around the active vertical bar cursor.

- Step 4:** Select **Horizontal Zoom in** from the side menu. The waveform will be enlarged horizontally.

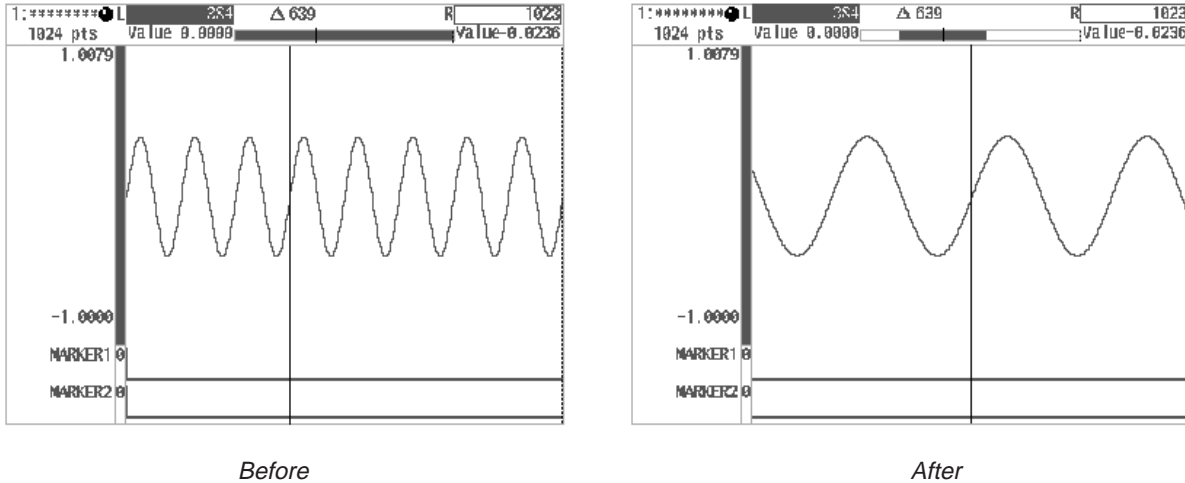

Figure 4A-76: Horizontal Zoom

- Step 5:** Select **Horizontal Zoom in** again from the side menu.

The degree of enlargement will increase each time the button is pressed. When the maximum enlargement is reached, the **Horizontal Zoom in** item will be disappeared. The displayed inverted portion of the horizontal scroll indicator above the waveform editing area indicates which section of the waveform is currently being displayed on the screen.

- Step 6:** Select **Horizontal Zoom out** from the side menu.

The degree of enlargement will decrease each time the button is pressed. When normal size (x1) is reached, the **Horizontal Zoom out** item will be disappeared.

- Step 7:** Select the **Horizontal Zoom in** item once again to enlarge the waveform.

- Step 8:** Select **Horizontal Pan** from the side menu.

This item enables you to scroll through the entire waveform by turning the general purpose knob. The displayed inverted portion of the horizontal scroll indicator above the waveform editing area indicates which section of the waveform is currently being displayed on the screen.

- Step 9:** Turn the general purpose knob and check to make sure the waveform moves horizontally.
- Step 10:** Select **Horizontal Zoom fit** from the side menu. The waveform will revert to normal size (x1).

Vertical zooming

Vertical
Zoom in

When the waveform is enlarged vertically with the **Vertical Zoom in** item, three new items will be added to the side menu:

- **Vertical Zoom out** Used to reduce the waveform
- **Vertical Zoom fit** Used to return to normal waveform size (x1)
- **Vertical Pan** Used to scroll through the waveform when it is enlarged

The process of vertical zooming is the same as that for horizontal zooming, except that enlargement and reduction occur with respect to the center of the vertical axis.

Figure 4A-77 shows an example of a waveform before and after vertical zooming.

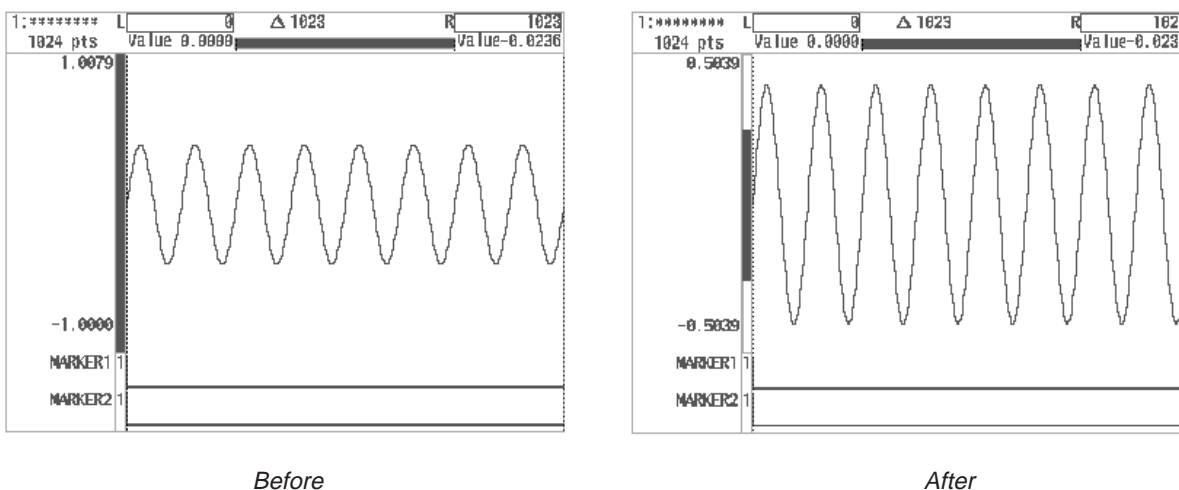

Figure 4A-77: Vertical Zoom

Timing Display

To show the timing display for the waveform editor using the **View type...** item in the **Setting** menu:

Procedure

- Step 1:** Select **Setting** from the bottom menu.
- Step 2:** Select **View type...** from the side menu.

Three items will be displayed in the sub-menu: **Graphic**, **Timing** and **Table**.

- Step 3:** Select **Timing** from the sub-menu.

The timing display of the waveform editor will appear. See Figure 4A-78.

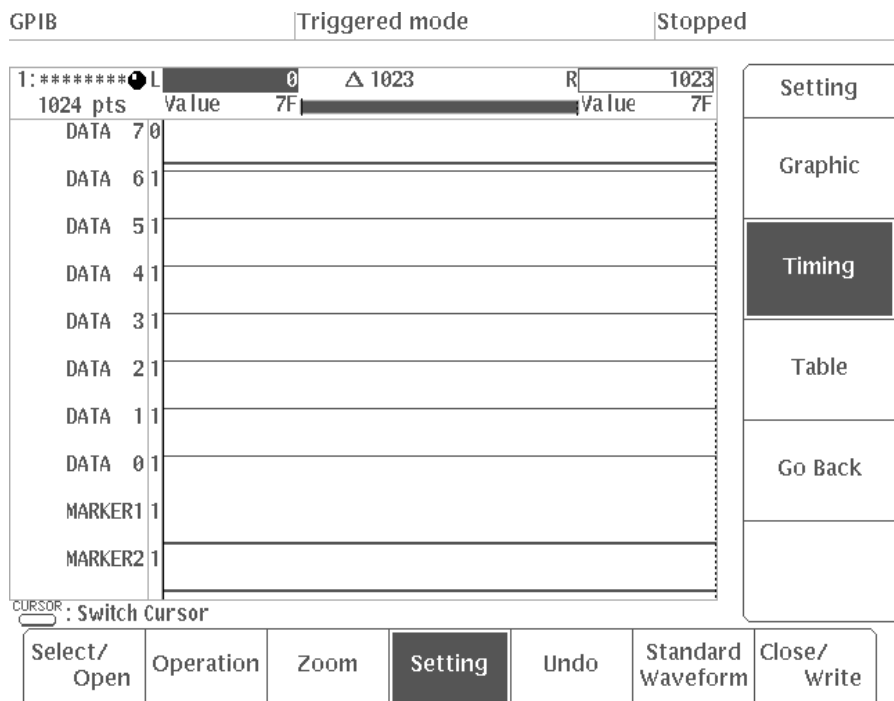
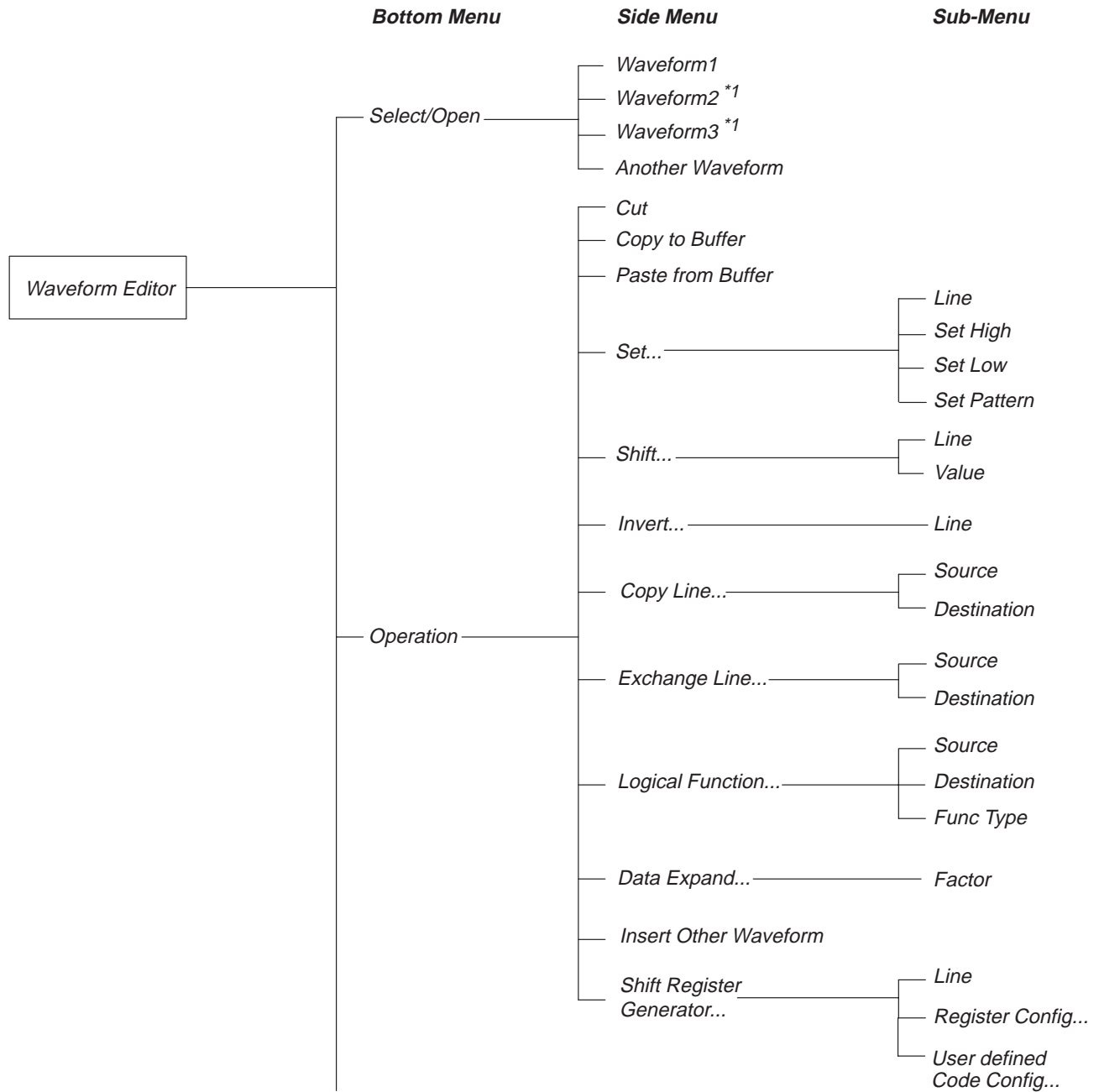

Figure 4A-78: Timing Display

- Step 4:** Select **Go Back** from the sub-menu. The system moves to the previous **Setting** side menu.

Timing Display Menu Structure

Figure 4A-79 shows the menu configuration for the timing display.



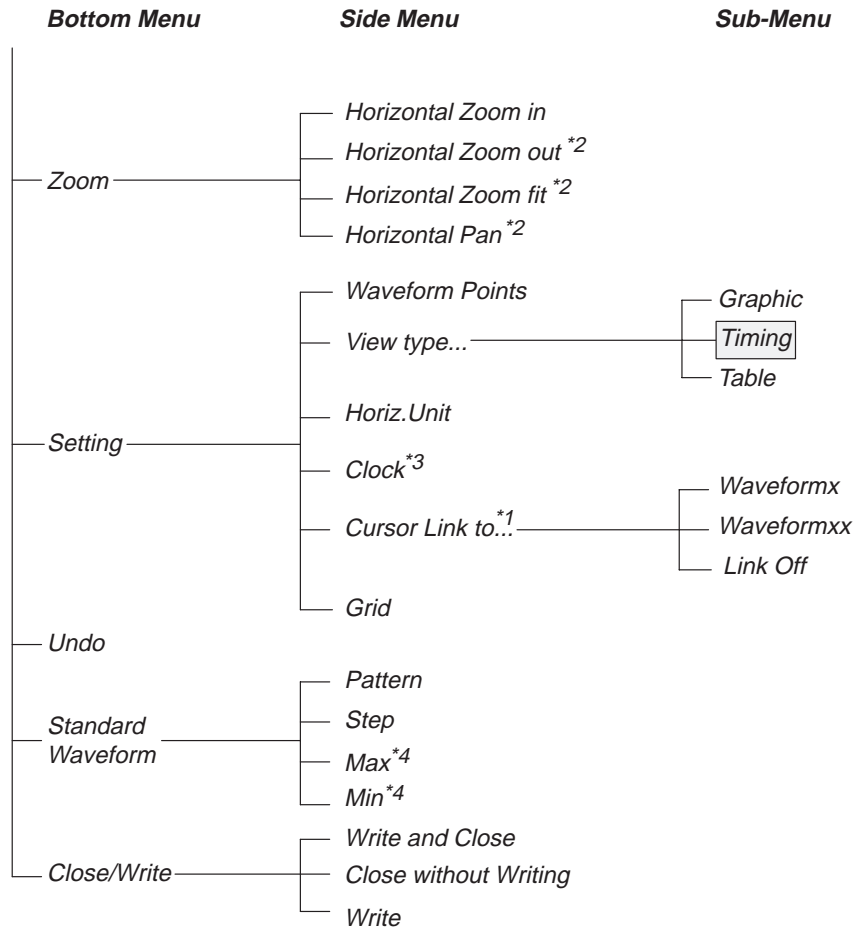

Figure 4A-79: Waveform Editor Timing Display Menu Structure

- *1 These items appear when two or more waveforms are being edited simultaneously with **Another Waveform** in the side menu (under **Select/Open** in the bottom menu).
- *2 These items appear when the displayed waveform data has been zoomed in the horizontal direction with **Horizontal Zoom** in in the side menu (under **Zoom** in the bottom menu).
- *3 This item appears when Time has been selected for **Horiz. Unit** in the side menu (under **Setting** in the bottom menu).
- *4 These items appear when **Count Up** or **Count Down** has been selected for **Pattern** in the side menu (under **Standard Waveform** in the bottom menu).

Menu Functions

The following list shows the functions available for each menu item and the page on which you can find a description of that function.

Table 4A-4: Menu Functions

Menu	Function	Page
Select /Open	Opening and selecting the editing area	4A-16
Operation	Editing waveform in timing display	4A-108
Cut	Cutting waveform	4A-45 , 4A-108
Copy to Buffer	Copying waveform	4A-46 , 4A-108
Paste from Buffer	Pasting waveform	4A-46 , 4A-108
Set...	Setting waveform data	4A-108
Shift...	Shifting waveform data	4A-120
Invert...	Inverting waveform data	4A-121
Copy Line...	Copying lines	4A-122
Exchange Line...	Exchanging lines	4A-124
Logical Function...	Applying logical operations to lines	4A-125
Data Expand...	Expanding waveform data	4A-126
Insert Other Waveform	Inserting other waveform data	4A-63 , 4A-127
Shift Register Generator...	Pseudo-random pulse generator using shift register	4A-127
Zoom	Zooming displayed waveform data	4A-97 , 4A-132
Setting	Settings for the waveform to be edited	4A-32 , 4A-105
Waveform Points...	Setting waveform point count	4A-33
View type...	Selecting the waveform data display format	4A-32
Horiz. Unit	Setting horizontal axis units	4A-34
Clock	Setting clock frequency	4A-35
Cursor Link to...	Linking the vertical bar cursors	4A-36
Grid	Displaying a grid in the editing area	4A-38
Undo	Undoing the previous operation	4-2
Standard Waveform	Creating standard waveform data	4A-105
Close/Write	Saving files and exiting the editor	4A-21

Timing Display Screen

Figure 4A-80 shows the timing display screen. This section will describe each portion of the screen; however, descriptions of areas that are identical to the graphic display will be omitted. See "Graphic Display Screen" for a description of the graphic display.

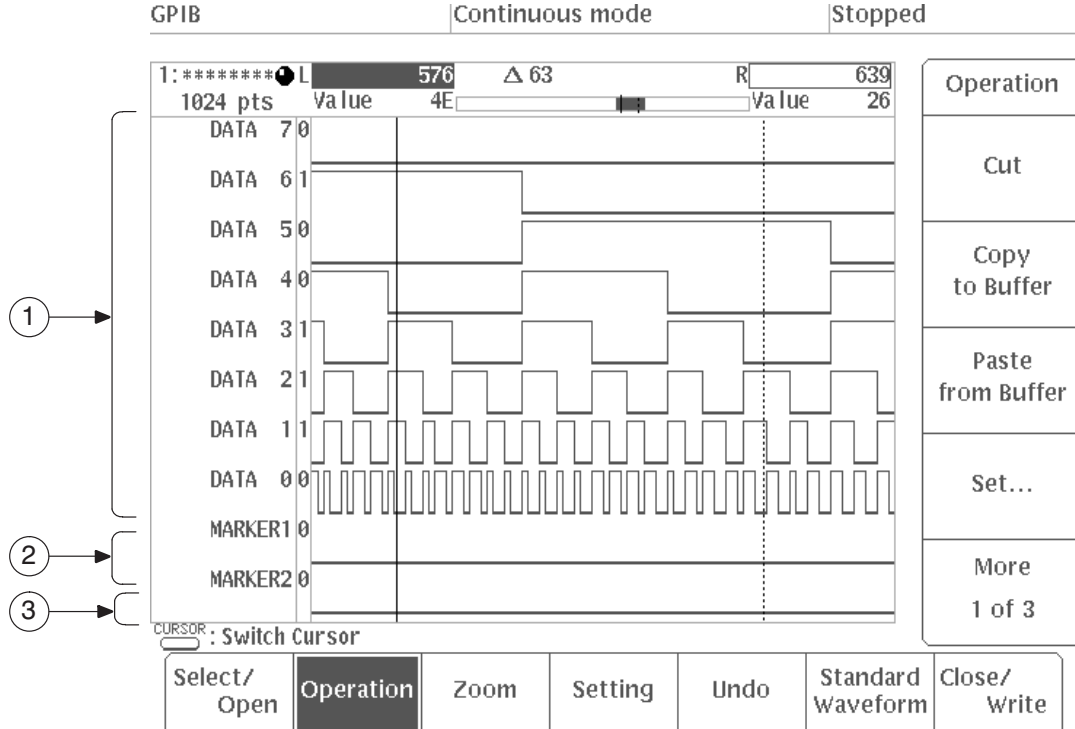

Figure 4A-80: Timing Display

(1) DATA 7 – DATA 0

This area shows the timing for each of the data lines (7 – 0). Data line 7 is the MSB. The number next to the line number (7 – 0) indicates the value of state at the time or point where of the active vertical bar cursor is located.

(2) Marker

This area shows the timing for the marker. The number to the right of the word "MARKER1" and "MARKER2" indicates the marker state at the time or point where the active vertical bar cursor is located.

(3) Button Operations

This area shows how the front panel buttons operate in this menu.

 : Switch Cursor

Pressing the **CURSOR** button toggles the active vertical bar cursor between left and right.

 : Move Cursor

When the **CURSOR** button is pressed, the vertical bar cursor can be moved.

Settings for the Waveform to be Edited

Setting

Before waveform data is created, you must use the Setting item in the side menu to set the environment for editing. The method used to set values is the same as for the graphic display. See "Setting for the Waveform to be Edited" for a description of the graphic display.

Creating Standard Waveform Data

Standard Waveform

Use this item to create waveform data in the area between the designated vertical bar cursors.

The following diagram shows the menu configuration for the **Standard Waveform** item.

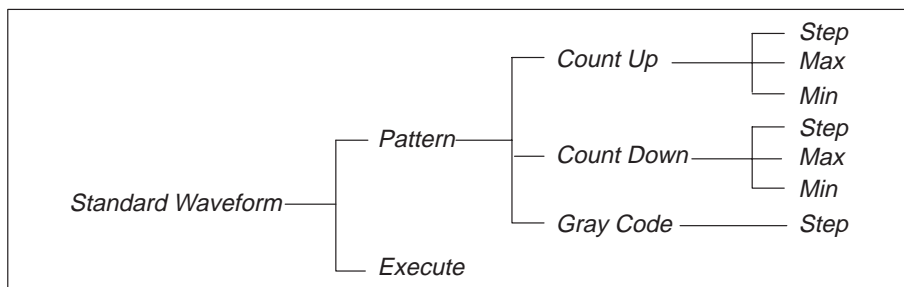

Pattern Types

Pattern

Use this item to select the waveform to be created. You can choose from the following three pattern options:

- Count Up** — Data is created sequentially, increasing from the initial value designated with **Min** to the maximum value designated with **Max**. When the maximum value is exceeded, the waveform will return to the initial value and begin counting up again. In the example shown in Figure 4A-81, the waveform point size is 1024, **Step** has been set to 2, and the **Min** and **Max** values have been set to 0 and 255, respectively. The pattern is repeated twice.

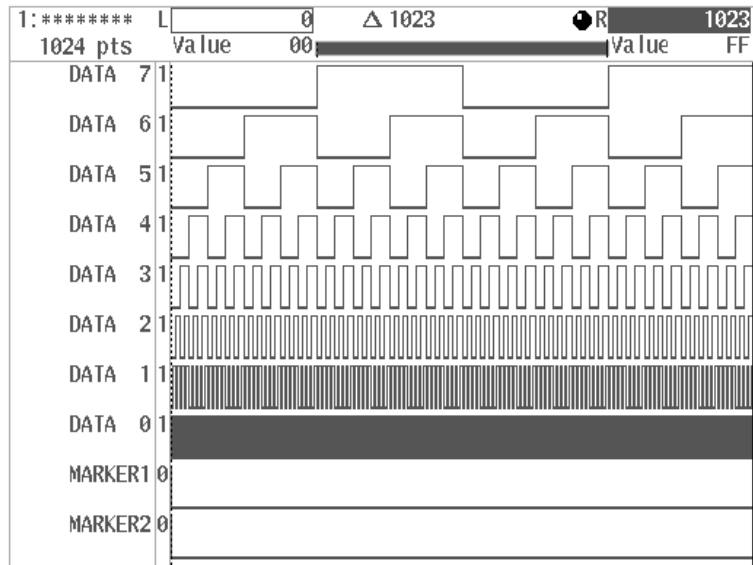

Figure 4A-81: Count Up Pattern Display

The following parameters can be set:

Step

Step — The number of points for each data item. This value can be set to 1 – 10.

Max

Max — The maximum value for the data. This value can be set anywhere between (**Min** value + 1) and 255.

Min

Min — The minimum value for the data. This value can be set anywhere between 0 and (**Max** value – 1).

- **Count Down** — Data is created sequentially, decreasing from the initial value designated for **Max** to the minimum value designated for **Min**. When the minimum value is exceeded, the value returns to the maximum value and countdown begins again. The values for **Step**, **Max** and **Min** can be set in the same manner as with **Count Up**.
- **Gray Code** — A data pattern is created in which the difference between adjacent data is only 1 bit. When the 256 items of 8-bit data end, the data repeats again from the beginning. In the example shown in Figure 4A-82, the waveform point size has been set to 1024 and **Step** has been set to 2. The pattern is repeated twice. Only the **Step** parameter is set for the **Gray Code** pattern option.

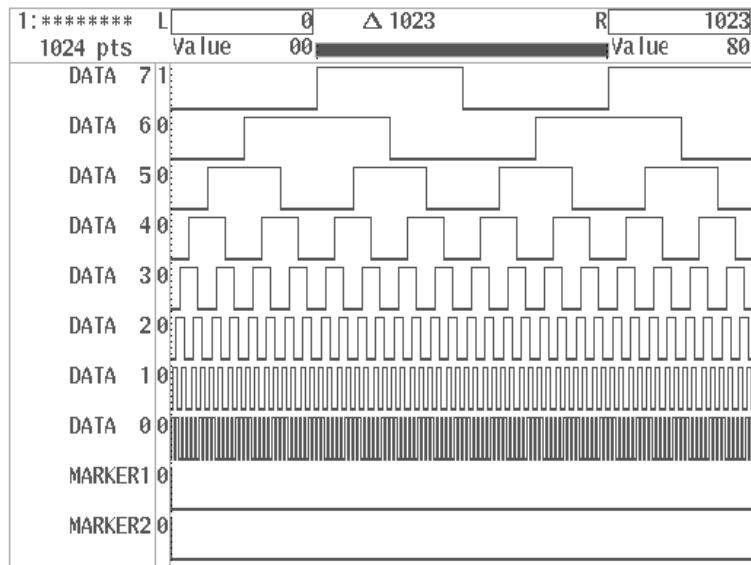

Figure 4A-82: Gray Code Pattern Display

Example of Waveform Data Creation

In the following operation, you will replace the data between the vertical bar cursors with a Count Up pattern, with the waveform point size set to 1024.

Procedure

- Step 1:** Select **Standard Waveform** from the bottom menu.
- Step 2:** Press the **CURSOR** button on the front panel. Using the general purpose knob, move the left and right vertical bar cursors all the way to the left and right, respectively, so the entire editing area is selected.
- Step 3:** Select **Pattern** from the side menu, then select **Count Up** by turning the general purpose knob or pressing the **Pattern** button in the side menu.
- Step 4:** Select **Step** from the side menu. Using the numeric keys or the general purpose knob, set the step to 2.
- Step 5:** Select **Max** from the side menu. Using the numeric keys or the general purpose knob, set the end point for the **Count Up** pattern to 255.
- Step 6:** Select **Min** from the side menu. Using the numeric keys or the general purpose knob, set the starting point for the **Count Up** pattern to 0.
- Step 7:** Select **Execute** from the side menu.

The data between the vertical bar cursors will be replaced by the **Count Up** pattern that you have designated. Figure 4A-81 shows the **Count Up** pattern created with the values used in this example.

Operation

Editing Waveform in Timing Display

Use Operation to edit the waveform data in a variety of ways.

The side menu is made up of 3 pages. To get to the next page of the menu, select **More**. The following list shows the names and functions of the items in the side menu.

- **Cut** Cutting waveform
- **Copy to Buffer** Copying waveform
- **Paste from Buffer** Pasting waveform
- **Set...** Setting waveform data
- **Shift...** Shifting waveform data
- **Invert...** Inverting waveform data
- **Copy Line...** Copying lines
- **Exchange Line...** Exchanging lines
- **Logical Function...** Applying logical operations to lines
- **Data Expand...** Expanding waveform data
- **Insert Other Waveform** Inserting other waveform data
- **Shift Register Generator...** Pseudo-random pulse generator using shift register

Cut, Copy, and Paste Processing Function

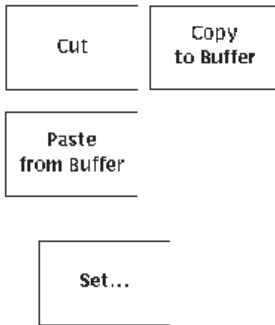

Use these functions cut, copy to the buffer, and paste to any other time or point value within the waveform data area between the vertical bar cursors. The functions for these items are the same as for the corresponding items in waveform editor graphic display. See Pages 4A-45 to 4A-46.

Setting Waveform Data

Use **Set...** to designate data for each data line and marker in the editing area between the designated vertical bar cursors. The following diagram shows the menu configuration for the **Set...** item.

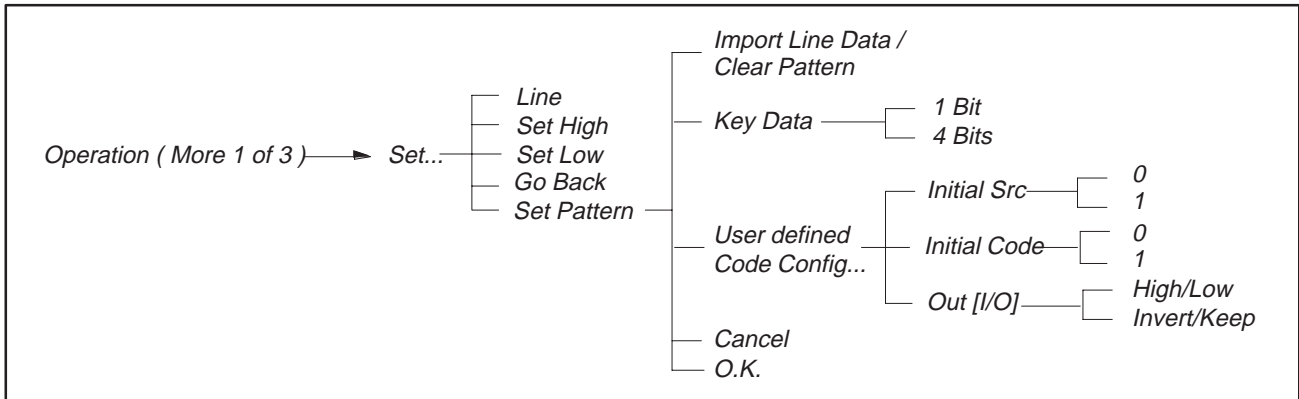



Setting Data to High/Low

Use **Set High** and **Set Low** to set the data lines or marker in the area designated by the designated vertical bar cursors to either High or Low.

Procedure

- Step 1:** Select **Set...** from the side menu displayed.
- Step 2:** Press the **CURSORS** button on the front panel.
- Step 3:** Using the general purpose knob, move the vertical bar cursors to designate the area for the High or Low state.
- Step 4:** Select **Line** from the sub-menu. Using the general purpose knob, select the data line (**DATA 7 – DATA 0**) or the marker (**MARKER1 – MARKER2**) that you want to set to **High** or **Low**.
- Step 5:** Select **Set High** or **Set Low** to set the state between the vertical bar cursors for the selected line.

Set High — Sets the state to High

Set Low — Sets the state to Low

Figure 4A-83 shows an example in which the state of the **DATA 3** line between the vertical bar cursors has been set to **Low**.

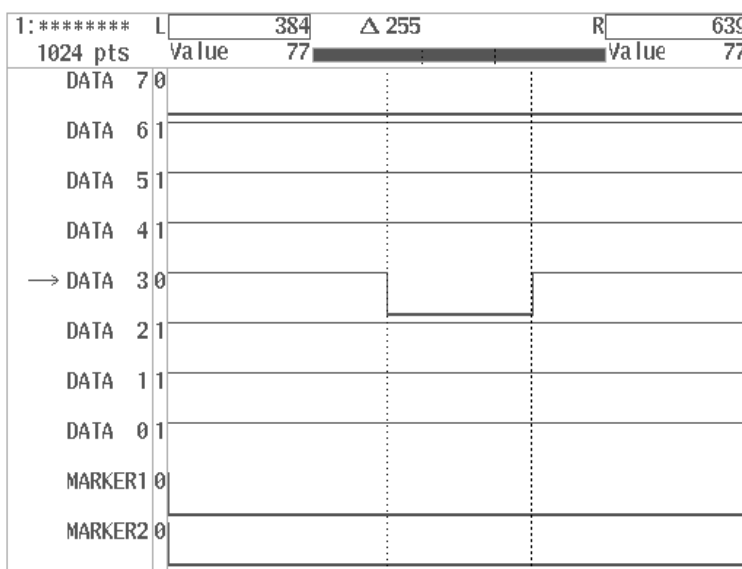

Figure 4A-83: Setting Waveform Data to High/Low

- Step 6:** Select **Go Back** from the current sub-menu. The system moves from the **Set...** sub-menu to the previous side menu.

Set
Pattern

Setting Pattern Data

Use **Set Pattern** to designate pattern data for the part of a data line or marker between the designated vertical bar cursors. Figure 4A-84 shows the pattern data menu that appears when you select **Set Pattern** from the sub-menu.

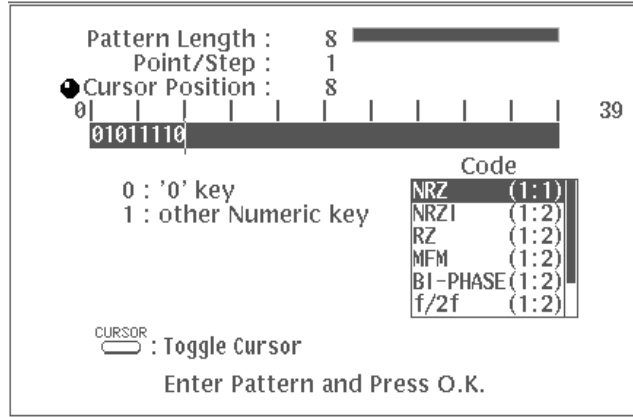

Figure 4A-84: Pattern Data Setting Menu

When the designated pattern is shorter than the area between the vertical bar cursors, the pattern data is repeated. You can create a variety of bit strings for the same pattern data by selecting **Code** in the menu.

Press the **CURSOR** button on the front panel to select the items needed for setting the pattern data. The following items can be selected; use the general purpose knob to set the desired value.

- **Cursor Position** sets the position of the cursor
- **Point/Step** sets the number of points per step
- **Code** used to select the data code

Entering Pattern Data and Pattern Length

To enter the pattern data, press the **CURSOR** button on the front panel and select **Cursor Position**. A knob icon will appear to the left of the **Cursor Position** area. The value next to "Cursor Position" in the menu indicates the current position of the cursor.

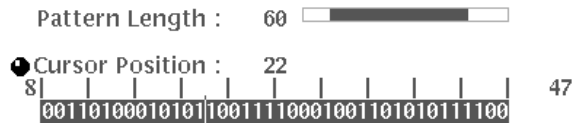

Now you can use the numeric keys to enter the pattern data. Any value up to 32,768 bits can be entered for pattern data. However, only 40 bits can be displayed on the screen at one time; use the general purpose knob to scroll through the rest of the data. The inverted display area in the **Pattern Length** area indicates the portion of the pattern data currently being displayed on the screen.

Pattern length indicates the length of the pattern data that has been entered. This value will increase each time more pattern data is entered.

Key Data
1 Bit
4 Bits

Changing the Data Bits

When entering pattern data, you can enter data either 1 bit at a time (for each keystroke) or 4 bits at a time, depending on the setting for **Key Data** in the side menu.

Key Data 1 Bit — When **Key Data** is set to **1 Bit**, the **0** key has a value of 0 and the other numeric keys have a value of 1, meaning that 1-bit data is inserted each time one of these keys is pressed. In the diagram shown below, numeric key values of **0**, **1**, **0** and **1** have been entered in that order.

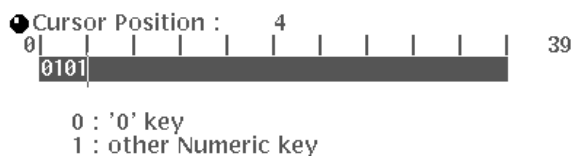

Key Data 4 Bits — When **Key Data** is set to **4 Bits**, a hexadecimal number (4-bit data) is entered each time one of the numeric keys is pressed. In the diagram shown below, numeric key values of **0**, **1** and **2** have been entered in that order.

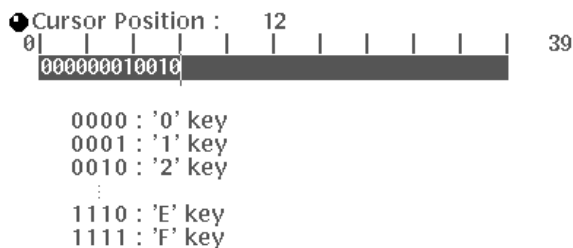

Point/Step

Point/Step is used to set how many points make up pattern data per bit. The data per bit after **Code** conversion will be one item of pattern data. For example, when **NRZ** is selected for **Code** and **Point/Step** is set to 2, each pattern will consist of 2 points.

To set the point size for each item of pattern data, press the **CURSOR** button on the front panel and then select **Point/Step**. A knob icon will appear to the left of the **Point/Step** area.



Pattern Code

Code is used to select the coding system used when the pattern strings are output. Depending on the designated length of the area between the vertical bar cursors, the code may be cut off in the middle. To select the code, use the following procedure:

Procedure

- Step 1:** Press the **CURSOR** button on the front panel and select **Code**. A knob icon will appear in the upper left-hand corner of the **Code** area.

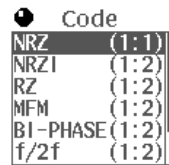

- Step 2:** Using the general purpose knob, select the desired code from the choices listed. The following 8 code options are available:

- NRZ
- NRZI
- RZ
- MFM
- BI-PHASE
- f/2f
- 1-7 RLL
- 2-7 RLL
- user defined

The "user defined" code allows the user to create a custom conversion table. See "User defined Code Conversion" later in this section. For a description of the other codes, see "Pattern Codes" in Appendix D.

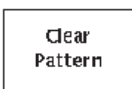

Clearing Pattern Data

Use **Clear Pattern** from the sub-menu to delete all of the pattern data that you have created.

Sample Pattern Data Setting

In the following example, pattern data (at **DATA 3**; **Point/Step**: 2, **Code**: NRZI) will be created in the area between the vertical bar cursors.

Procedure

- Step 1:** Select **Set...** from the side menu.
- Step 2:** Press the **CURSORS** button on the front panel.
- Step 3:** Using the general purpose knob, move the vertical bar cursors to define the area in which the pattern will be set. In this example, we will set the left vertical bar cursor to 256 and the right vertical bar cursor to 767.
- Step 4:** Select **Line** from the sub-menu. Turning the general purpose knob, select **DATA3** for which you want to set the pattern.
- Step 5:** Select **Set Pattern** from the sub-menu.
- Step 6:** Press the **CURSORS** button on the front panel to select **Cursor Position**.
- Step 7:** Press the **Key Data** button in the sub-menu to select 4 Bits.
- Step 8:** Press **1, 2** in that order.



- Step 9:** Press the **CURSORS** button on the front panel to select **Point/Step**.
- Step 10:** Using the general purpose knob, set **Point/Step** to 2.

Point/Step : 2

- Step 11:** Press the **CURSORS** button on the front panel to select **Code**.
- Step 12:** Using the general purpose knob, select **NRZI**.

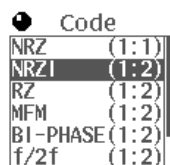

- Step 13:** Select **O.K.** from the sub-menu. The pattern that you have set in the preceding steps will appear between the vertical bar cursors. See Figure 4A-85.

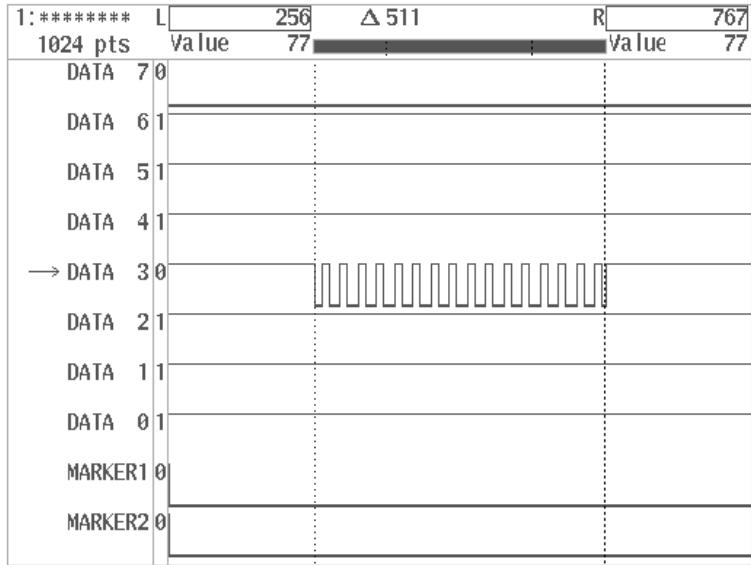

Figure 4A-85: Setting Pattern Data

User defined Code Config...

User defined Code Config...

Users can define their own conversion tables for code conversion. This function enables RLL codes, etc. to be freely defined. For sample codes, see "Pattern Codes" in Appendix D. Conversion tables defined with this menu item are protected by the backup battery, so they are preserved even after the power is turned off. To reset this item to the factory default (**NRZ**), select **Reset to Factory** in the **UTILITY** menu.

Procedure

The following process is used to create a user-defined conversion table.

- Step 1:** Perform steps 1 through 5 of the sample process for defining pattern data.
- Step 2:** Select **User defined Code Config...** from the side menu. See Figure 4A-86.

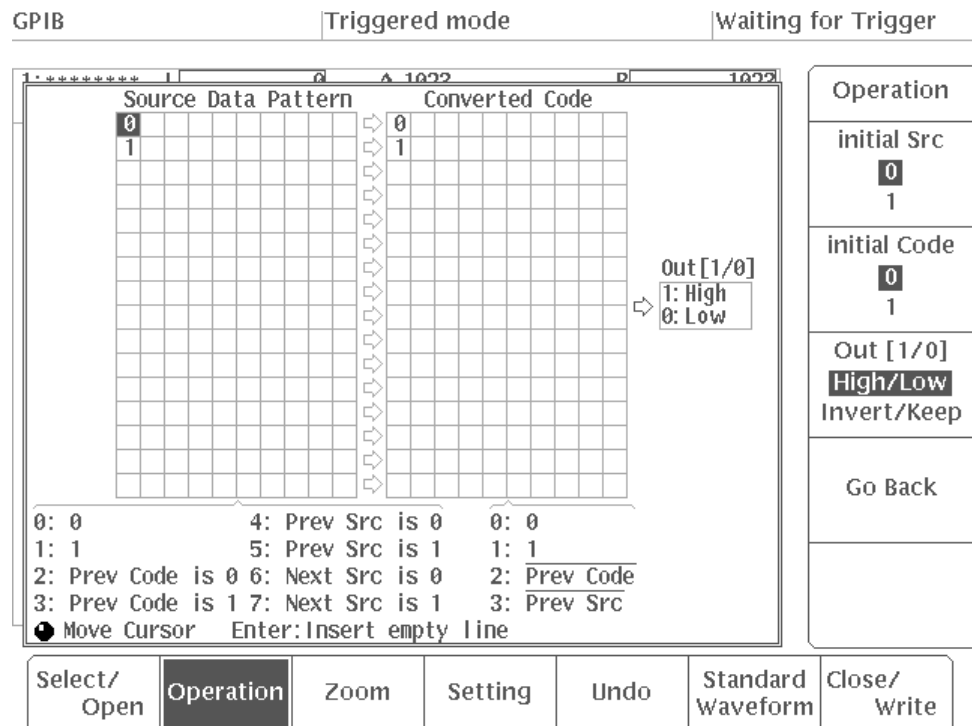

Figure 4A-86: User defined Code Conversion Menu

- Step 3:** Define the codes as desired (see "Basic Operations" on the following page).
- Step 4:** Select **Go Back** to return to the **Set Pattern** menu.
- Step 5:** Define the pattern data, using the same procedure as in steps 6 – 10 of the sample process for defining pattern data.
- Step 6:** Press the **CURSOR** button to select **Code** menu item. A knob icon will appear in the upper left side of the code selection menu.
- Step 7:** Turn the general purpose knob to select **user defined**.
- Step 8:** Press **O.K.** in the sub-menu to execute code conversion. The result will be inserted between the cursors on the data line defined in Step 1.

Basic Operations

Moving the Cursor

To move the cursor, turn the general purpose knob. The cursor can be moved throughout the area where data has already been defined, plus one more space. From the **Source Data Pattern** item, the cursor moves to the **Converted Code** item. When the cursor reaches the last data item, it will return to the beginning. The cursor can also be moved using the left and right arrow buttons.

Inserting a Blank Line

Pressing the **ENTER** key causes a blank line to be inserted above the data item marked by the cursor.

NOTE. Blank lines cannot be inserted if there are more than two consecutive blank lines or if there are more than 16 lines in all.

Defining Data

Move the cursor to the desired location to enter a value on the numeric keys. The value at that location will be replaced by the one you have entered. Enterable values will vary depending on the location of the cursor:

In the **Source Data Pattern** area, only numeric keys 0 through 7 are operational.

In the **Converted Code** area, only numeric keys 0 through 3 are operational.

Deleting Data

Pressing the delete key will delete the data indicated by the cursor. When a data item is deleted, all of the subsequent data items will move forward one space. If there is no data at the cursor position, the cursor will move one position to the left.

Deleting a Line

When all of the data on the line indicated by the cursor has been deleted, that line will also be deleted and all subsequent data will move up one line.

Setting Items

Source Data Pattern

- 0: 0
- 1: 1
- 2: Prev Code is 0
- 3: Prev Code is 1
- 4: Prev Src is 0
- 5: Prev Src is 1
- 6: Next Src is 0
- 7: Next Src is 1

Used to write the pattern for input data.

- 0 Data at that position is LOW
- 1 Data at that position is HIGH
- 2 The preceding Converted Code data item is 0
- 3 The preceding Converted Code data item is 1
- 4 The preceding Source Data Pattern data item is 0
- 5 The preceding Source Data Pattern data item is 1
- 6 The following Source Data Pattern data item is 0

7 The following Source Data Pattern data item is 1

Limitations

- 2, 3, 4 and 5 can only be written at the beginning of **Source Data Pattern**
- 6 and 7 cannot be written at the beginning of **Source Data Pattern**
- Only the data for the immediately preceding time can be referenced with 2, 3, 4 and 5
- 6 and 7 are effective as long as the pattern can be written
- After the first time 6 and 7 appear, 0 will be treated as 6 and 1 will be treated as 7
- 6 and 7 read the input data and search for the same pattern. When the same pattern has been detected, the portion of the data that has been read is returned to its original status and then the next pattern is analyzed.
- 0, 1, 2, 3, 4, 5, 6 and 7 can be used together

Converted Code

0: 0
 1: 1
 2: Prev Code
 3: Prev Src

Writes the output data pattern

- 0 Sets the output data to LOW
- 1 Sets the output data to HIGH
- 2 Turns the inverse of the preceding **Converted Code** data item into output data
- 3 Turns the inverse of the preceding **Source Data Pattern** data item into output data

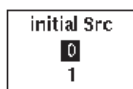

The default value for the source pattern. Affects output data when the **Source Data Pattern** is 4 and 5 and when 3 is used for **Converted Code**.

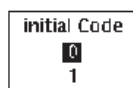

The default value for the output pattern. Affects output data when the **Source Data Pattern** is 2 and 3; when 2 is used for **Converted Code**; and when **Out [1/0]** is set to **Invert/Keep**.

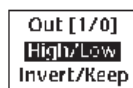

Determines the handling of 1/0 for data converted using **Converted Code**.

High/Low 1: data HIGH 0: data LOW
Invert/Keep 1: output is inverted 0: data is output as is

Sample Conversion

(1) When **Source Data Pattern** is unaffected by other conditions

Initial Sr 0
Initial Code 0
Out[1/0] High/Low

Source Data Pattern	Converted Code
00	00
01	11
10	20
11	30

In the case of the above conversion, the data will be as follows:

Position	-3	-2	-1	0	1	2	3	4	5	6	7
Source Data Pattern	0	0	0	1	1	0	1	1	0	1	0
Converted Code	0	0	1	3	0	1	1	2	0	2	0
Result	0	0	1	1	0	1	1	0	0	1	0

NOTE.

- 1) 3 of 30 in pattern 11 starting from position 0 is the inverse of the 0 in the **Source Data Pattern** at position -1.
- 2) 2 of 20 in pattern 10 starting from position 4 is the inverse of result 1 at position 3.
- 3) 2 of 20 in pattern 10 starting from position 6 is the inverse of result 0 at position 5.

When **Out[1/0]** is set to **Invert/Keep** for the same table, the data will be as follows:

Source Data Pattern	0	0	0	1	1	0	1	1	0	1	0
Converted Code	0	0	1	3	0	1	1	2	0	2	0
Invert/Keep (Previous)	0	0	1	1	0	1	1	0	0	1	0
Result	0	0	1	0	0	1	0	0	0	1	1

(2)When **Source Data Pattern** is affected by other conditions

- If 4 and 5 are used:

Initial Sr 0
Initial Code 0
Out[1/0] High/Low

Source Data Pattern	Converted Code
40	0001
41	010
50	0100
51	1000

Time	-1	0	1	2	3	4	5	6	7	8
Input	0	0	1	0	1	1	0	1	0	0
Pattern	40	40	41	50	41	51	50	41	50	40

- If 6 and 7 are used (1):

Initial Sr **0**
Initial Code **0**
Out[1/0] **High/Low**

Source Data Pattern	Converted Code
07	0001
17	0010
06	0100
16	1000

In the case of the above conversion, the data will be as follows:

Time	-1	0	1	2	3	4	5	6	7	8
Input	0	0	1	0	1	1	0	1	0	0
Pattern	06	07	16	07	17	16	07	16	06	

- If 6 and 7 are used (2):

Initial Sr **0**
Initial Code **0**
Out[1/0] **High/Low**

Source Data Pattern	Converted Code
077	00000001
076	00000010
177	00000100
176	00001000
067	00010000
066	00100000
167	01000000
166	10000000

In the case of the above conversion, the data will be as follows:

Time	-1	0	1	2	3	4	5	6	7	8
Input	0	0	1	0	1	1	0	1	0	0
Pattern	067	076	167	077	176	167	076	166		

Importing Waveform or Marker Data as Pattern Data

Import
Line Data

This command is used to import the selected bit data as pattern data. It can be used to perform code conversion even for waveform data.

The commands in the **Import Line Data** menu will change depending on whether or not there is data in the pattern data area. When there is no data, the **Import Line Data command** will appear in the sub-menu. When data has been entered, this command will change to **Clear Pattern**.

Procedure

- Step 1:** Select **Set...** from the side menu.
- Step 2:** Select the data to be imported and then use the cursors to specify the required range.
- Step 3:** Select **Set Pattern** from the sub-menu.
- Step 4:** If pattern data exists, press **Clear Pattern** button in the sub-menu to clear the existing data.
- Step 5:** Select **Import Line Data** from the sub-menu.
The selected bit data will be read into the pattern data input area.

Clear Pattern

Clear
Pattern

When data has been entered in the pattern data input area, the **Import Line Data** item in the sub-menu will change to **Clear Pattern**. Pressing the **Clear Pattern** button will delete all pattern data.

Shifting Waveform Data

Shift...

Use the **Shift** function to shift the data between the designated vertical bar cursors in individual data lines or markers by the specified points or time. The following diagram shows the menu configuration for the **Shift...** item.

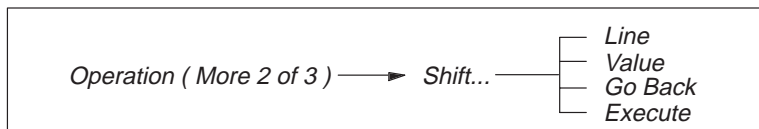

Procedure

- Step 1:** Move the vertical bar cursors to define the part of the waveform data to be shifted, then select **Shift...** from the second page of the side menu (**More 2 of 3**).
- Step 2:** Select **Line** from the sub-menu. Turning the general purpose knob, select the data line (**DATA 7 – DATA 0**) or marker (**MARKER1** or **MARKER2**) on which the data is to be shifted.
- Step 3:** Select **Value** from the sub-menu. Using the general purpose knob or the numeric keys, input the shift point value.

Value sets the amount of the shift in points or time. The range for the shift value is \pm (designated waveform point size). To shift the data between the vertical bar cursors to the right, enter a positive value; points that shift out beyond the right cursor will be shifted in from the left. To shift the data to the left, enter a negative number; points that shift out beyond the left cursor will be shifted in from the right.

- Step 4:** Select **Execute** from the side menu. The waveform data is shifted with the specified conditions. Figure 4A-87 shows the screen before and after the data on line DATA 5 between the vertical bar cursors is shifted 32 points to the right.

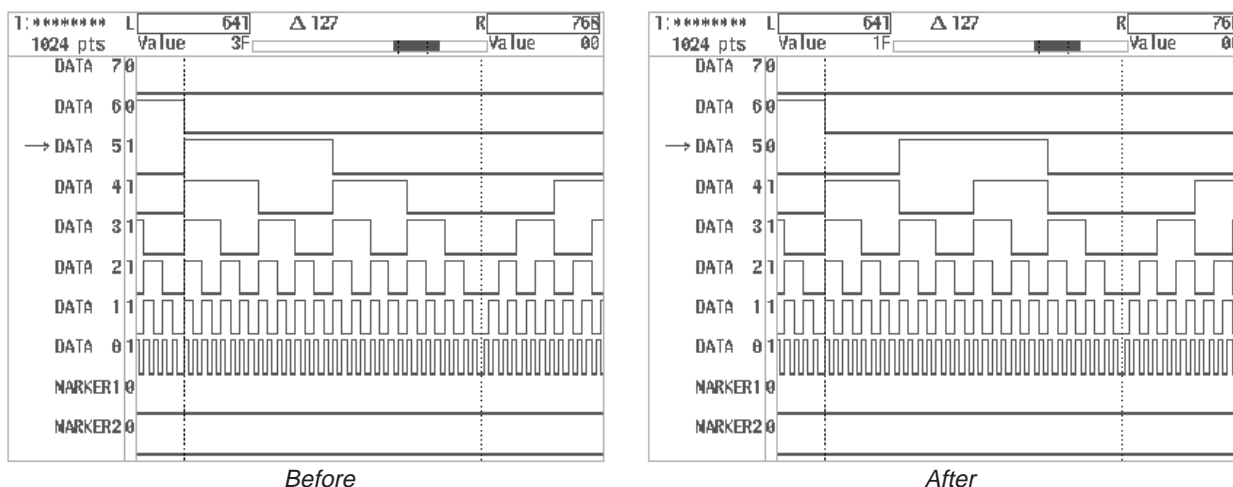
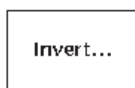

Figure 4A-87: Shifting Waveform Data

- Step 5:** Select **Go Back** from the current sub-menu. The display returns from the **Shift...** sub-menu to the previous side menu.

Inverting Waveform Data



Use **Invert...** to invert each data line or marker between the designated vertical bar cursors. The following diagram shows the menu configuration for the **Invert...** item.

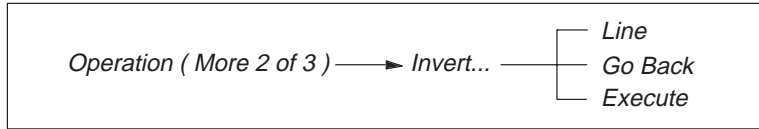

Procedure

- Step 1:** Move the vertical bar cursors to define the section of the data to be inverted. Then select **Invert...** from the second page of the side menu (**More 2 of 3**).
- Step 2:** Select **Line** from the sub-menu. Turning the general purpose knob, select the data line or marker whose state is to be inverted.
- Step 3:** Select **Execute** from the sub-menu. The state is inverted with the specified conditions. Figure 4A-88 shows the screen before and after the data between the vertical bar cursors on line **DATA 5** is inverted.

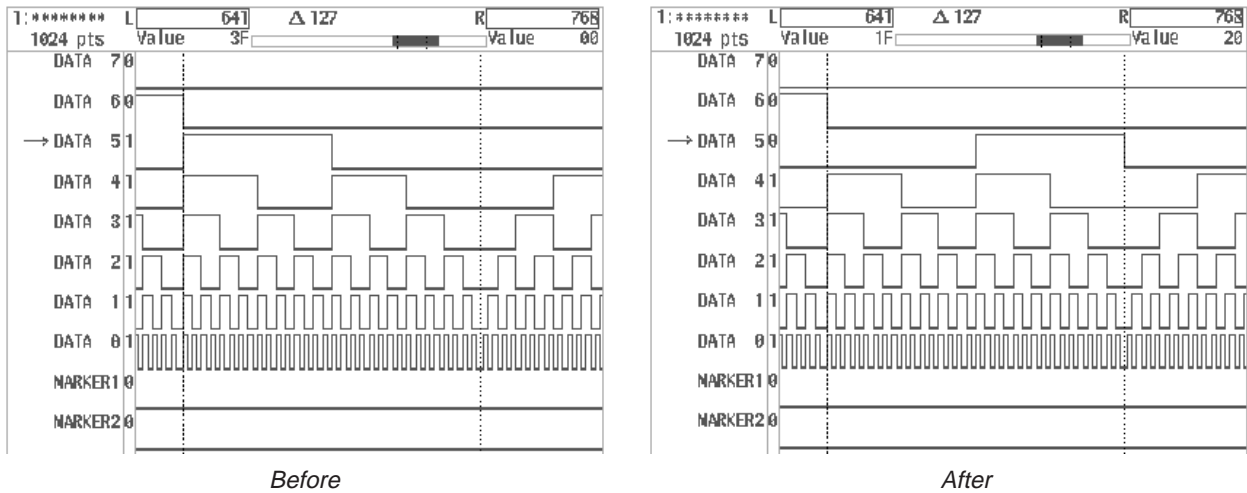
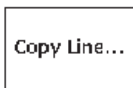

Figure 4A-88: Inverting Waveform Data State

- Step 4:** Select **Go Back** from the current sub-menu. The display returns from the **Invert...** sub-menu to the previous side menu.

Copying Lines



Use **Copy line...** to copy the waveform data between the designated vertical bar cursors from one data line to another data line. Copy processing replaces the previous value of the copy destination line with the data of the copy source. The following diagram shows the menu configuration for the **Copy Line...** item.



Procedure

Step 1: Move the vertical bar cursors to define the section of the data to be copied. Then select **Copy Line...** from the second page of the side menu (**More 2 of 3**).

Step 2: Select **Source** from the sub-menu. Turning the general purpose knob, select the copy source data line or marker.

Source selects the waveform data copy source. Data line **DATA 7 – DATA 0** or marker (**MARKER1** or **MARKER2**) can be selected.

Step 3: Select **Destination** from the sub-menu. Turning the general purpose knob, select the copy destination data line or marker.

Destination selects the destination to which the waveform data selected with **Source** will be copied. Data line **DATA 7 – DATA 0** or marker (**MARKER1** or **MARKER2**) can be selected as the copy destination. From the copy source to the copy destination is indicated with an arrow.

Step 4: Select **Execute** from the sub-menu. The data is copied with the specified conditions. Figure 4A-89 shows the screen before and after the section of waveform data between the vertical bar cursors on line **DATA 0** is copied to line **DATA 7**.

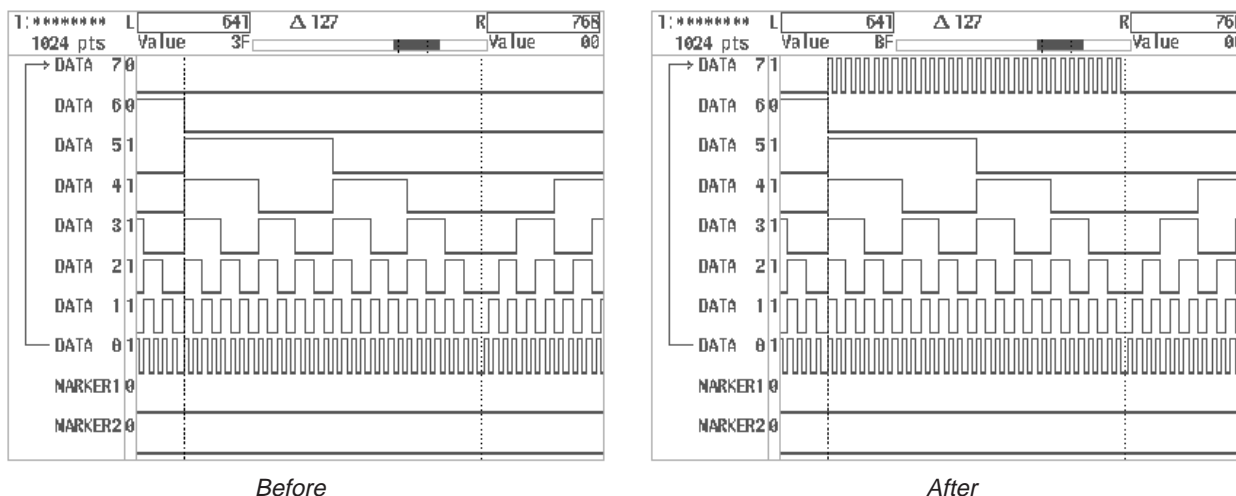

Figure 4A-89: Copying Lines

Step 5: Select **Go Back** from the current sub-menu. The display returns from the **Copy Line...** sub-menu to the previous side menu.

Exchange Line...

Exchanging Lines

Use **Exchange Line...** to take the data between the designated vertical bar cursors on one line and interchange it with the data on another line. The following diagram shows the menu configuration for the **Exchange Line...** item.

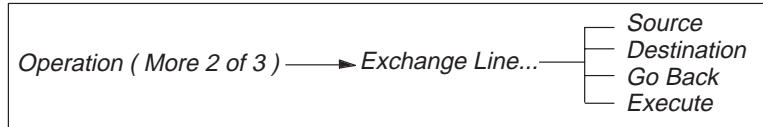

Procedure

- Step 1:** Move the vertical bar cursors to define the section of the data to be exchanged. Then select **Exchange Line...** from the second page of the side menu (**More 2 of 3**).
- Step 2:** Select **Source** from the sub-menu. Turning the general purpose knob, select one of the data lines or marker for data interchange.
- Step 3:** Select **Destination** from the sub-menu. Turning the general purpose knob, select the other data line or marker for data interchange.
- Step 4:** Select **Execute** from the sub-menu. The data will be exchanged as designated. Figure 4A-90 shows the screen before and after the data on line **DATA 0** is exchanged with the data on line **DATA 7**.

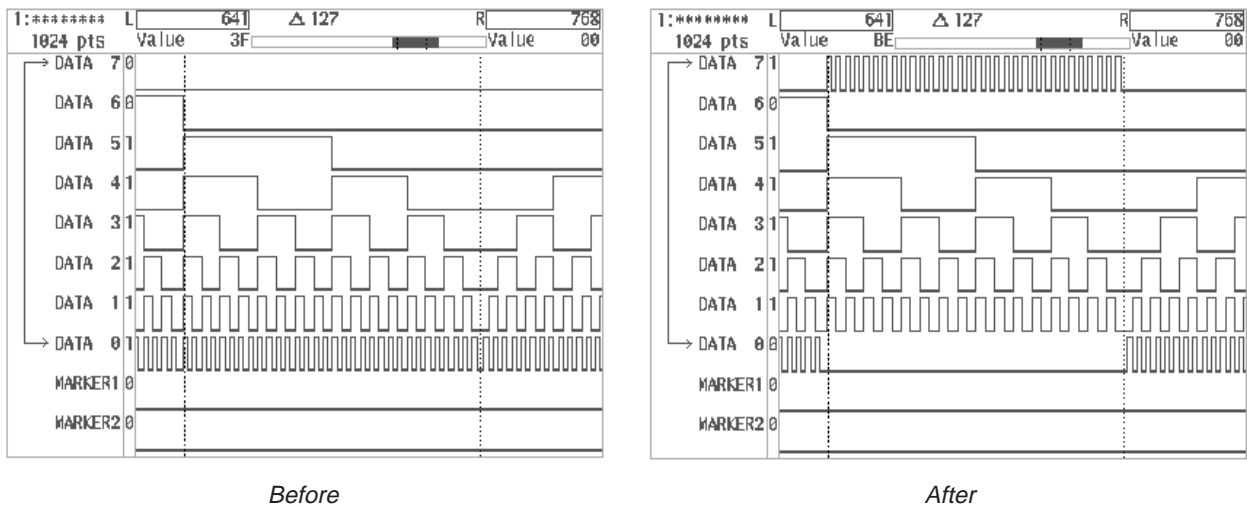

Figure 4A-90: Exchanging Lines

- Step 5:** Select **Go Back** from the current sub-menu. The display returns from the **Exchange Line...** sub-menu to the previous side menu.

Logical
Function...

Applying Logical Operations to Lines

Use **Logical Function...** to perform a logical operation for the waveform data between the designated vertical bar cursors on one line with the data on another line. The result will replace the data on the line designated with **Destination**. The following diagram shows the menu configuration for the **Logical Function...** item.

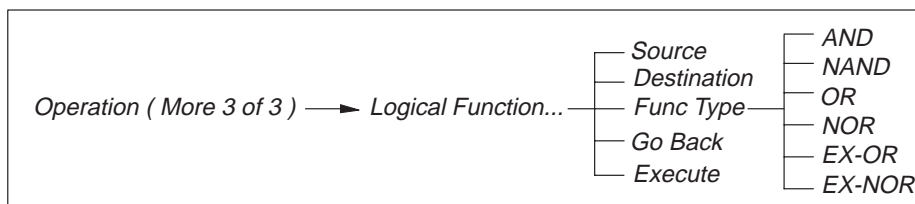

Types of Logical Operations

You can choose from the following six logical operation options in the **Func Type** sub-menu:

- AND
- NAND
- OR
- NOR
- EX-OR
- EX-NOR

See "Logical Operation" in Appendix D for a description of each of these operations.

Procedure

- Step 1:** Move the vertical bar cursors to define the section of the data to which a logical operation is applied. Then select **Logical Function...** from the third page of the side menu (**More 3 of 3**).
- Step 2:** Select **Source** from the sub-menu. Turning the general purpose knob, select the first data line or marker for logical operation.
- Step 3:** Select **Destination** from the sub-menu. Turning the general purpose knob, select the other data line or marker for logical operation. The calculated result will replace the data line or marker designated with **Destination**.
- Step 4:** Select **Func Type** from the sub-menu. Turning the general purpose knob, select the logical operation (e.g. AND, OR, EX-OR).
- Step 5:** Select **Execute** from the sub-menu. Logical operation will be performed for the selected lines.
- Step 6:** Select **Go Back** from the current sub-menu. The display returns from the **Logical Function...** sub-menu to the previous side menu.

Data
Expand...

Expanding Waveform Data

Use **Data Expand...** to expand the section between the designated vertical bar cursors for all of the data lines and marker. The following diagram shows the menu configuration for the **Data Expand...** item.

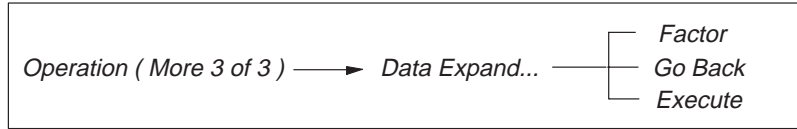

Procedure

- Step 1:** Move the vertical bar cursors to define the section of the data to be expanded. Then select **Data Expand...** from the third page of the side menu (**More 3 of 3**).
- Step 2:** Select **Factor** from the sub-menu.
Factor is used to set the degree of expansion to any value between 2x and 10x.
- Step 3:** Using the numeric keys or the general purpose knob, set the degree of expansion.
- Step 4:** Select **Execute** from the sub-menu. The section of the waveform between the vertical bar cursors will be expanded to the designated degree, and the waveform point size will increase accordingly. Figure 4A-91 shows the screen before and after the data between the vertical bar cursors is expanded by a factor of 2.

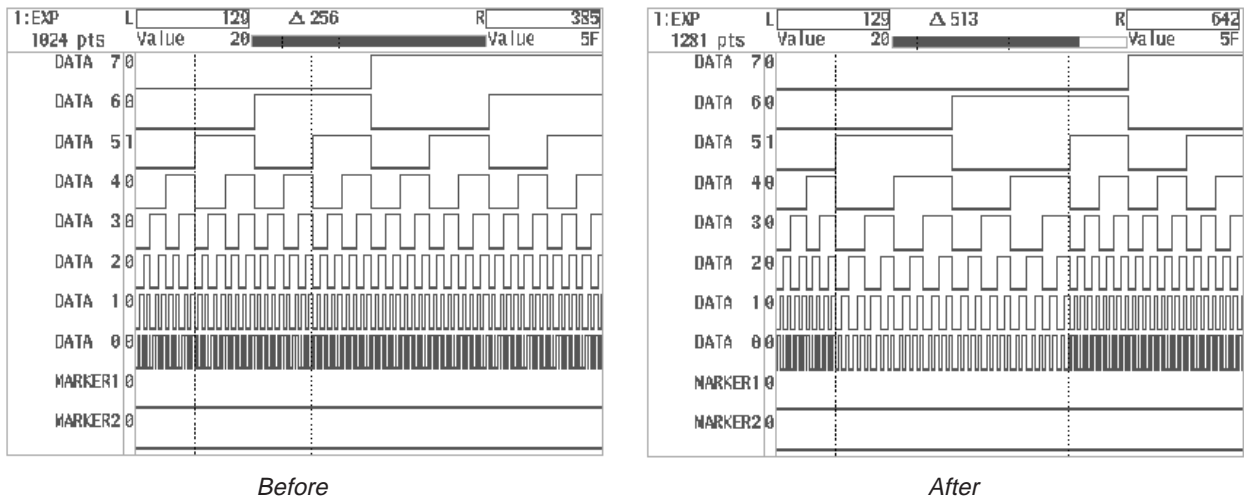

Figure 4A-91: Expanding Waveform Data

- Step 5:** Select **Go Back** from the current sub-menu. The display returns from the **Data Expand...** sub-menu to the previous side menu.

Inserting Other Waveform Data

Insert
Other
Waveform

Use **Insert Other Waveform** to insert data from another waveform at a designated point in the waveform being edited. This item is located on the third page (**More 3 of 3**) of the side menu. The functions of this item are the same as for the **Insert Other Waveform** item for the graphic display of the waveform editor. See Page 4A-62.

Pseudo-Random Pulse Generator Using Shift Register

Shift
Register
Generator...

Use **Shift Register Generator...** to set a pseudo-random pulse pattern using a shift register for the data between the designated vertical bar cursors on a data line or marker. The following diagram shows the menu configuration for the **Shift Register Generator...** item.

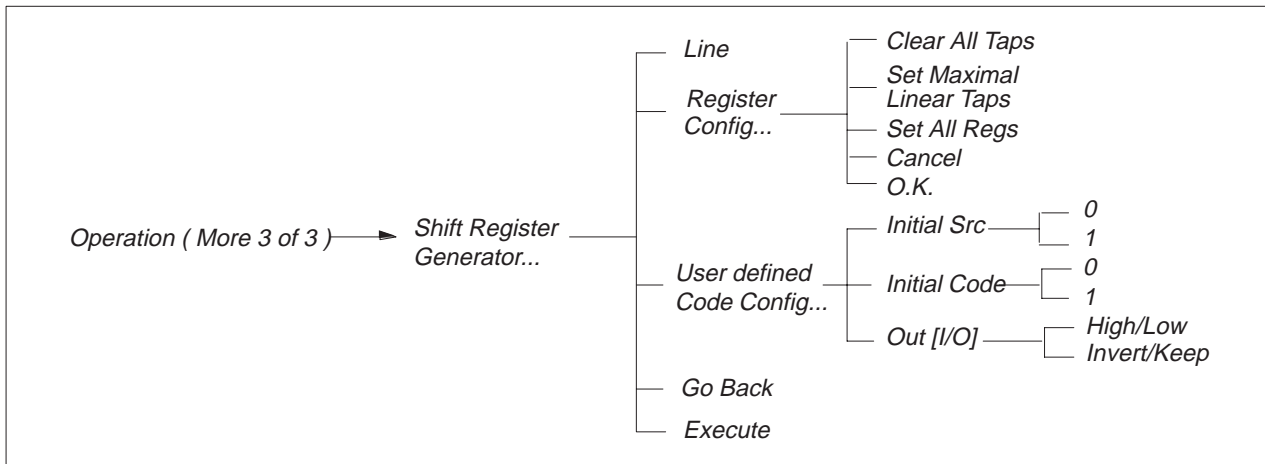

Register Configuration

Register
Config...

The pseudo-random pulse generator (with shift register) consists of 2 to 32 registers together with the register output for each and the tap of the feedback loop that performs the EX-OR operation. Selecting **Register Config...** from the sub-menu enables you to set the pattern for the shift register generator. Figure 4A-92 shows the menu used to set the shift register.

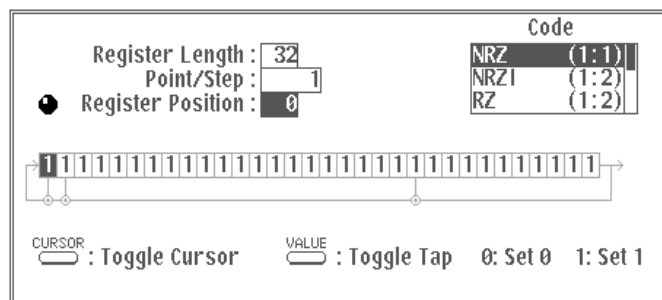

Figure 4A-92: Shift Register Configuration Menu

Use the **CURSOR** button on the front panel to select the items needed for the shift register. The following items can be selected; the general purpose knob is used to set the desired value for each item.

- **Register Length** sets the length of the register
- **Register Position** sets the position of the cursor
- **Point/Step** sets the number of points per step
- **Code** used to select the data code

Setting the Register Length

The register length may be set to any value between 2 and 32. The register length is displayed at the top of the shift register configuration menu, as shown below. In this example, the shift register is made up of 32 items.



Entering the Register Value and Setting Taps

To enter the register value and set taps, press the **CURSOR** button on the front panel and select **Register Position**. A knob icon will be displayed to the left of the **Register Position** area. Turn the general purpose knob to move the cursor. The current location of the cursor is shown beside the **Register Position** item.

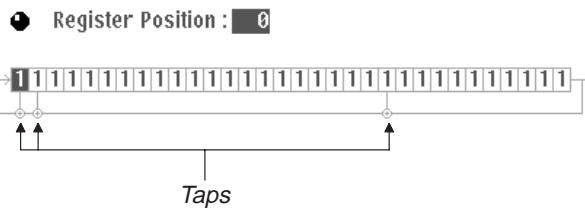

Figure 4A-93: Register Values and Taps

The numeric keys can now be used to enter the register value at the position of the cursor.

- Press **0** to set the register value to 0
- Press **1** to set the register value to 1

Pressing the **VALUE** button on the front panel toggles the tap between on and off.

Clearing All Taps

Use **Clear All Taps** in the sub-menu to delete all taps that have been set.



Set
Maximal
Linear Taps

Setting the Maximum Length Code Series for Taps

Set Maximal Linear Taps in the sub-menu allows you to create M series (maximum length code series) bit strings. M series bit strings are combined with several different kinds of tap arrangements. The tap arrangement will change each time the **Set Maximal Linear Taps** button is pressed.

Set
All Regs

Setting Register Values

Use **Set All Regs** in the sub-menu to set all register values to 1.

Sample Settings for Register Values and Taps

You can easily set register and tap values as follows:

Register Length: 3

Register Value: 101

Use **Set Maximal Linear Taps** to set taps

Figure 4A-94 shows the output for the above settings. This output will be the maximum length code series.

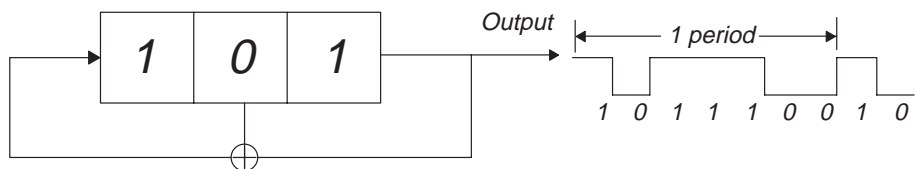

Figure 4A-94: Sample Settings for Register Values and Taps

Point/Step

Point/Step is used to set how many points make up each data bit. The data after **Code** conversion will be one item of bit data. For example, when **NRZI** is selected for **Code** and **Point/Step** is set to 2, each data bit will consist of 4 points.

Point/Step : 2

Code

This command selects the code system used when data pattern strings are output. The **user defined** code enables you to define a custom conversion table. For a detailed description of each code, see "Pattern Codes" in Appendix D.

Code

NRZ	(1:1)
NRZI	(1:2)
RZ	(1:2)

User defined Code Config...

The following process is used to execute a user-defined code conversion.

- Step 1:** Select **Shift Register Generator...** from the side menu.
- Step 2:** Select **User defined Code Config...** from the sub menu.
- Step 3:** Define the codes as desired. For the basic operations used when defining codes, see "User defined Code Config..." on page 4A-114.
- Step 4:** Select **Go Back** to return to the **Shift Register Generator...** menu.
- Step 5:** Select **Register Config...** from the side menu.
- Step 6:** Set the values for **Register Length** and **Point/Step** as well as the register value and tap.
- Step 7:** Press the **CURSOR** button to select Code menu item. A knob icon will appear in the upper left side of the **Code** selection menu.
- Step 8:** Turn the general purpose knob to select **user defined**.
- Step 9:** Press **O.K.** in the sub-menu to confirm the settings. The **Shift Register Generator...** menu will automatically reappear.
- Step 10:** Using the general purpose knob, define the data line and area where the pattern will be inserted.
- Step 11:** Press **Execute** in the sub-menu. The result will be inserted between the cursors on the data line selected in the previous step.

Creating the M Series Pseudo-Random Signal

An M series pseudo-random signal has a length of $2^n - 1$ assuming the number of levels for the shift register is n. In this example, we will create an M series pseudo-random signal of $2^{15} - 1$ bits (15 levels) with 2 points for each step. This signal is included on the Sample Waveform Library Disk that came with the AWG2041.

Procedure

- Step 1:** Select **Setting** from the bottom menu.
- Step 2:** Select **Waveform Points** from the side menu. Then set the waveform point size to 65534 using the numeric keys. The waveform point size needed to display all the bits of the pseudo-random signal is given by the following formula:

$$(\text{Value for Point/Step}) \times (2^n - 1) = 2 \times (2^{15} - 1) = 65534$$

- Step 3:** Select **Shift Register Generator...** from the third page of the side menu (**More 3 of 3**).
- Step 4:** Press the **CURSOR** button on the front panel.

- Step 5:** Using the general purpose knob, move the vertical bar cursors to designate the area to which pseudo-random signals are inserted. In this example, we will set the left cursor to point 0 and the right cursor to point 65533.
- Step 6:** Select **Line** from the sub-menu. Turning the general purpose knob, select **DATA7** for which you want to set the pattern.
- Step 7:** Select **Register Config...** from the sub-menu.
- Step 8:** Press the **CURSOR** button on the front panel to select **Register Length**.
- Step 9:** Using the general purpose knob, set the register length to 15.

● Register Length : 15

- Step 10:** Select **Clear All Taps** in the sub-menu to delete all taps.
- Step 11:** Select **Set All Regs** in the sub-menu to set all registers to 1.
- Step 12:** Press the **CURSOR** button on the front panel to select **Register Position**.
- Step 13:** Using the general purpose knob, set the **Register Position** to 13.
- Step 14:** Press the **VALUE** button on the front panel to set the tap.

● Register Position : 13



- Step 15:** Press the **CURSOR** button on the front panel to select **Point/Step**.
- Step 16:** Using the general purpose knob, set **Point/Step** to 2.

● Point/Step : 2

- Step 17:** Press the **CURSOR** button on the front panel to select **Code**.
- Step 18:** Using the general purpose knob, select **NRZ**.

● Code

NRZ	(1:1)
NRZI	(1:2)
RZ	(1:2)

- Step 19:** Select **O.K.** from the sub-menu.
- Step 20:** Select **Execute** from the sub-menu. The timing display shown below will appear. The following figure shows the first 1024 points of the data.



- Step 21:** Select **Go Back** from the sub-menu.

NOTE. $2^n - 1$ is not a multiple of 32. Therefore, when performing continuous output of a pseudo-random signal, you should designate a suitable number of repetitions in the sequence editor to form a multiple of 32. In this example, you should set the number of repetitions to 16.

Zoom

Zooming Waveforms

Use **Zoom** in the bottom menu to horizontally enlarge or reduce the waveform being displayed. The function for this item is the same as for the **Zoom** item in for waveform editor graphic display. See Page 4A-96.

Table Display

To show the table display for the waveform editor using the **View type...** item in the **Setting** menu:

Procedure

- Step 1:** Select **Setting** from the bottom menu.
- Step 2:** Select **View type...** from the side menu.

Three items will be displayed in the sub-menu: **Graphic**, **Timing** and **Table**.

- Step 3:** Select **Table** from the sub-menu.

The table display of the waveform editor will appear. See Figure 4A-95.

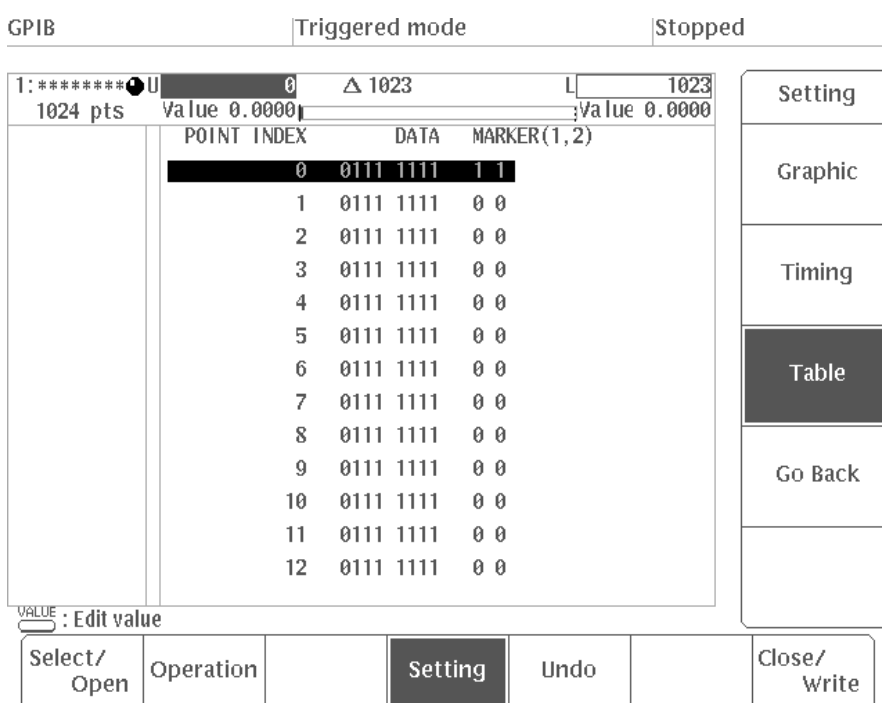

Figure 4A-95: Table Display

- Step 4:** Select **Go Back** from the sub-menu. The system moves to the previous **Setting** side menu.

Table Display Menu Structure

Figure 4A-96 shows the menu configuration for the table display.

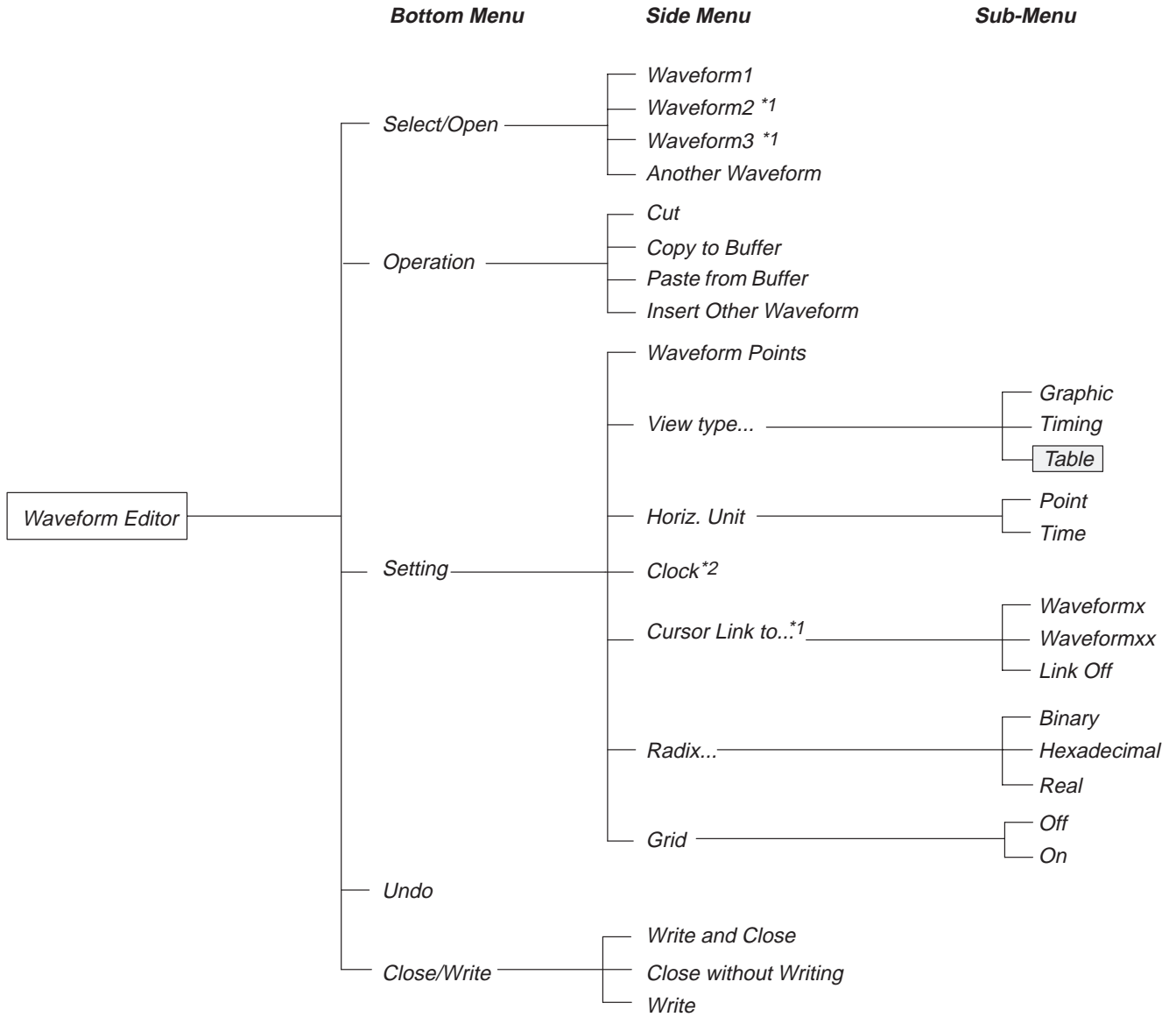

Figure 4A-96: Waveform Editor Table Display Menu Structure

*1 This item appears when two or more waveforms are being edited simultaneously with **Another Waveform** in the side menu (under **Select/Open** in the bottom menu).

*2 This item appears when **Time** has been selected for **Horiz. Unit** in the side menu (under **Setting** in the bottom menu).

Menu Functions

The following list shows the functions available for each menu item and the page on which you can find a description of that function.

Table 4A-5: Menu Functions

Menu	Function	Page
Select /Open	Opening and selecting the editing area	4A-16
Operation	Editing waveform in table display	4A-140
Cut	Cutting waveform	4A-45 , 4A-140
Copy to Buffer	Copying waveform	4A-46 , 4A-140
Paste from Buffer	Pasting waveform	4A-46 , 4A-140
Insert Other Waveform	Inserting other waveform data	4A-63 , 4A-140
Setting	Settings for the waveform to be edited	4A-32 , 4A-138
Waveform Points	Setting waveform point count	4A-33
View type...	Selecting the waveform data display format	4A-32
Horiz. Unit	Setting horizontal axis units	4A-34
Clock	Setting clock frequency	4A-35
Cursor Link to...	Linking the vertical bar cursors	4A-36
Radix...	Setting a cardinal number	4A-138
Grid	Displaying a grid in the editing area	4A-38
Undo	Undoing the previous operation	4-2
Close/Write	Saving files and exiting the editor	4A-21

Table Display Screen

Figure 4A-97 shows the table display screen. This section will describe each portion of the screen; however, descriptions of areas that are identical to the graphic display will be omitted. See "Graphic Display Screen" for a description of the graphic display.

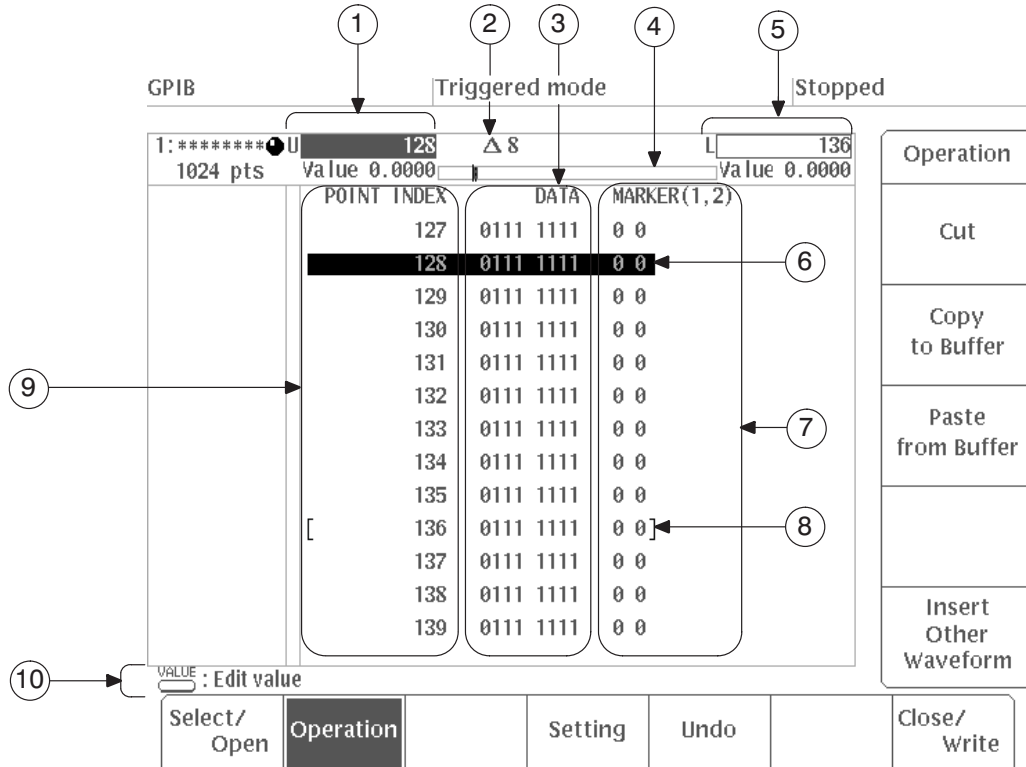

Figure 4A-97: Table Display Screen

(1) U

Value

Shows the data value (**Value**) indicated by a real number and the time or point value (**U**) for the current position of the upper line cursor. The value in the displayed inverted field can be changed using the numeric keys or the general purpose knob.

(2) Δ

Shows the time or point count between the upper and lower vertical bar cursors.

(3) Data

This shows the waveform data for the waveform point count or time. The waveform data can be displayed as binary, hexadecimal, or decimal data, depending which base has been selected. If binary numbers have been selected, the left end of the data is the most significant bit (**MSB**).

(4) Horizontal Scroll Indicator

Indicates which portion of the waveform is currently displayed on the screen. The displayed inverted portion of the indicator shows the portion of the waveform currently being displayed.

(5) L**Value**

Shows the data value (**Value**) indicated by a real number and the time or point value (**L**) for the current position of the lower line cursor.

(6) Upper Line Cursor

The line that is brightly highlighted by the upper line cursor is active.

(7) MARKER

Binary display of the state of Marker 1 and 2 for the waveform point or time. Marker 2 is on the right.

(8) Lower Line Cursor

The line cursor enclosed in a frame ([]) is inactive.

(9) Point Index or Time Index

Shows the waveform point or time. The units are set with the **Setting** item in the bottom menu.

(10) Button Operations

This area shows how the front panel buttons operate in this menu.

 : Edit value

When the **VALUE** button is pressed, a block cursor appears within the inverted display cursor and the numeric keys can be used to input the data. Pressing an arrow button (←/→) moves the block cursor left/right.

 : Move Line Cursor

When the **CURSOR** button is pressed, the line cursor can be moved.

Setting

Settings for the Waveform to be Edited

Before waveform data is created, you must use the side menu items of the **Setting** bottom menu to select the environment for editing. Apart from the cardinal number settings, the procedure for setting values is the same as for the graphic display. See "Setting for the Waveform to be Edited" for a description of the graphic display.

Radix...

Setting a Cardinal Number

Use **Radix...** to set a cardinal number to display waveform data in a table format. Waveform data can be displayed in numeric form as **Binary**, **Hexadecimal** or **Real** numbers.

When Radix... is selected, the following items appear in the sub-menu:

- **Binary**
- **Hexadecimal**
- **Real**
- **Go Back**

The description of these cardinal numbers is given below.

Binary — 8-bit waveform data is created using the **0** or **1** numeric keys.

Hexadecimal — Waveform data is created using the **0–9** and **A–F** numeric keys. When the cardinal numbers are changed to **Hexadecimal**, numeric keys and unit keys are allocated to **A–F**.

Real — The data is input, as with regular number input, by pressing numeric keys, then pressing the **ENTER** key to enter the number. Any real number (**Real**), up to the vertical axis full scale, can be entered in the graphic display.

The markers are displayed in binary notation even when the cardinal numbers are set to **Hexadecimal** or **Real**.

Procedure

- Step 1:** Select **Setting** from the bottom menu.
- Step 2:** Select **Radix...** from the second page of the side menu (**More 2 of 2**).
- Step 3:** Select the desired cardinal number (**Binary**, **Hexadecimal** or **Real**) from the sub-menu. Figure 4A-98 shows how the same waveform data is displayed in each of the cardinal numbers.

Binary				Hexadecimal				Real			
POINT INDEX	DATA	MARKER		POINT INDEX	DATA	MARKER		POINT INDEX	DATA	MARKER	
128	1101 1001	0 0		128	D9	0 0		128	0.7087	0 0	
129	1101 1001	0 0		129	D9	0 0		129	0.7087	0 0	
130	1101 1010	0 0		130	DA	0 0		130	0.7165	0 0	
131	1101 1010	0 0		131	DA	0 0		131	0.7165	0 0	
132	1101 1011	0 0		132	DB	0 0		132	0.7244	0 0	
133	1101 1100	0 0		133	DC	0 0		133	0.7323	0 0	
134	1101 1100	0 0		134	DC	0 0		134	0.7323	0 0	
135	1101 1101	0 0		135	DD	0 0		135	0.7402	0 0	
136	1101 1101	0 0		136	DD	0 0		136	0.7402	0 0	
137	1101 1110	0 0		137	DE	0 0		137	0.7480	0 0	
138	1101 1110	0 0		138	DE	0 0		138	0.7480	0 0	
139	1101 1111	0 0		139	DF	0 0		139	0.7559	0 0	
140	1101 1111	0 0		140	DF	0 0		140	0.7559	0 0	

Binary
Hexadecimal
Real

Figure 4A-98: Numeric Displays for Waveform Data

- Step 4:** Select **Go Back** from the current sub-menu. The display returns from the **Binary...** sub-menu to the previous side menu.

Editing Waveform Data

Waveform data can be edited regardless of what item is selected in the bottom menu.

Procedure

To move the line cursor to the data point to be edited:

- Step 1:** Press the **CURSOR** button on the front panel to move the line cursor.
- Step 2:** When the **CURSOR** button is pressed, the active line cursor is toggled between upper and lower.
- Step 3:** Use the general purpose knob to move the active line cursor to the time or point value to be edited.

To enter waveform data:

- Step 4:** Press the **VALUE** button on the front panel to input the waveform data with the set cardinal number.

Within the inverted display active line cursor is a block cursor. The data in the block cursor can be changed.

- Step 5:** Use the ← and → buttons on the front panel to move the block cursor to the data to be changed.

When the block cursor is at the left end of the waveform data, pressing the ← button moves the block cursor to marker for the previous waveform point or time value. When the block cursor is at the right end of the waveform data, pressing the → button moves the block cursor to the top digit of the subsequent waveform point or time value.

- Step 6:** Data can be input with the numeric keys. Pressing numeric or character keys unrelated to the cardinal number you have designated will have no effect on the data.

When a number or character is input, the block cursor moves to the next character to the right.

Operation

Editing Waveform in Table Display

Use **Operation** to edit waveform data for the area between the upper and lower horizontal line cursors.

The following list shows the names and functions of the items in the side menu.

- **Cut** Cutting waveform
- **Copy to Buffer** Copying waveform
- **Paste from Buffer** Pasting waveform
- **Insert Other Waveform** Inserting other waveform data

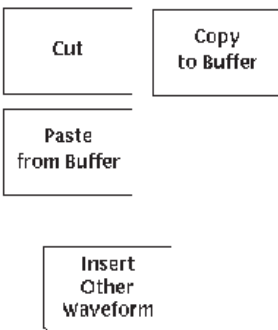

Cut, Copy, and Paste Processing Function

Use these functions cut, copy to the buffer, and paste to any other time or point value within the waveform data area between the upper and lower line cursors. The functions for these items are the same as for the corresponding items in waveform editor graphic display. See Pages 4A-45 to 4A-46.

Inserting Other Waveform Data

Use **Insert Other Waveform** to insert data from another waveform at a designated point in the waveform being edited. The functions of this item are the same as for the **Insert Other Waveform** item for the graphic display of the waveform editor. See Page 4A-62.

Equation Editor

Use the equation editor to create or edit files with the extension of **.EQU**. Equation file data takes the form of mathematical equations. An equation program file can have up to 100 lines. An equation file is compiled to create a waveform file and to output the waveform.

Figure 4A-99 shows an example of a waveform obtained by compiling the data from an equation file and its equation.

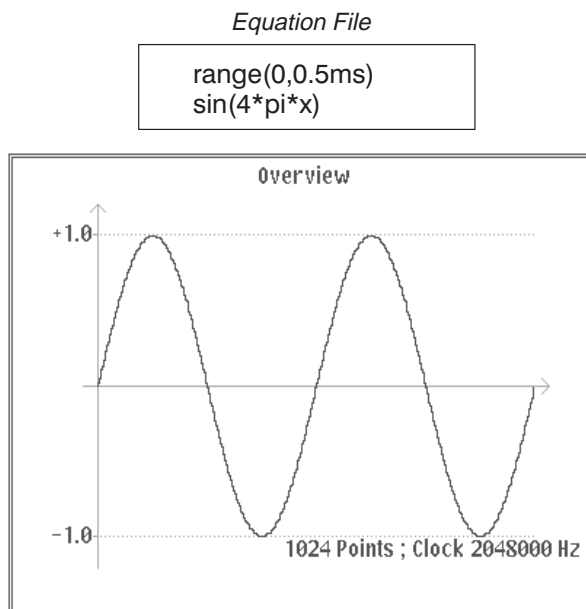

Figure 4A-99: Example of Equation File Data and Resulting Waveform



Entering the Equation Editor

Procedure

Step 1: Press the **EDIT** button in the **MENU** column. The initial **EDIT** menu will appear.

Step 2: Select **Edit** or **New Equation** from the side menu.

Edit — Used to select and edit an existing equation file (**.EQU**)

New Equation — Used to create a new equation file

The equation editor screen will appear.

Saving Files and Exiting the Editor

Use **Exit/Write** in the bottom menu to save the file (which you have either created or edited) to the internal memory of the AWG2041 and exit from the editor depending on the selected side menu item.

The same procedure is used to save the file and exit from the equation editor as for the waveform editor. See "Saving Files and Exiting the Editor" in the section on the waveform editor.

When you compile the equation then exit the equation editor, the waveform file and the equation file are saved in internal memory with the same name but different extension.

NOTE. *If there is already a waveform file in internal memory with the name the compiled waveform file will be given, a message is displayed asking if you are sure you want to overwrite the old file. Answer either **Cancel** or **O.K.***

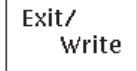

Equation Editor Menu Structure

The equation editor menu has the structure shown in Figure 4A-100.

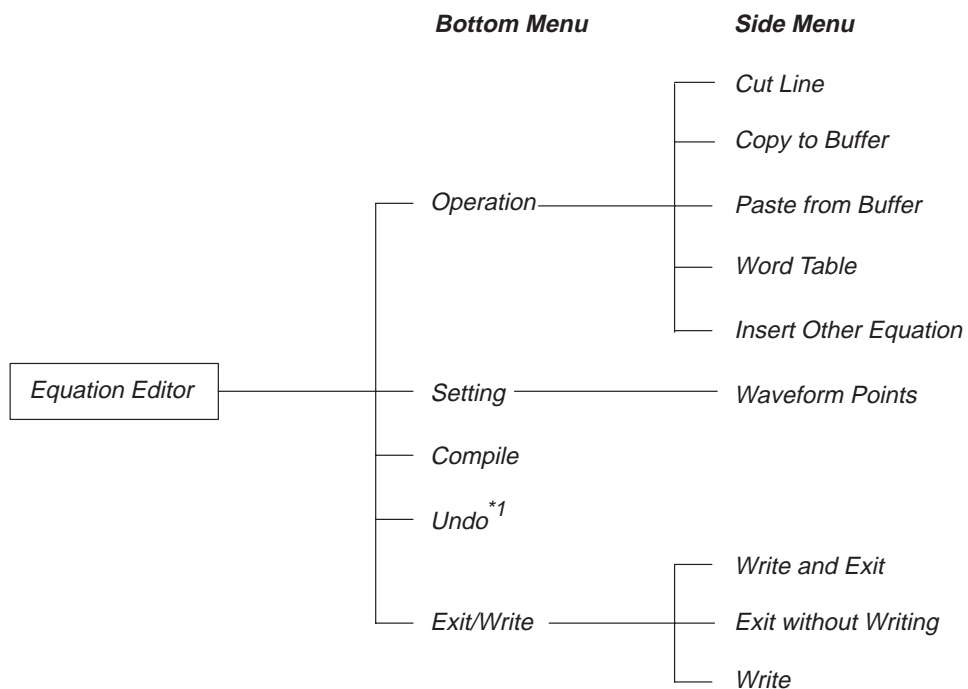

Figure 4A-100: Equation Editor Menu Structure

*1 This item appears when **Operation** in the bottom menu has been selected.

Menu Functions

The following list shows the functions available for each menu item and the page on which you can find a description of that function.

Table 4A-6: Menu Functions

Menu	Function	Page
Operation	Editing function	4A-160
Cut Line	Cutting a line	4A-160
Copy to Buffer	Copying a line	4A-160
Paste from Buffer	Pasting a line	4A-160
Word Table	Changing the component menu	4A-149
Insert Other Equation	Inserting other equation file	4A-161
Setting		
Waveform Points	Setting waveform point count	4A-162
Compile	Compiling equations into waveform data	4A-163
Undo	Undoing the previous operation	4-2
Exit/Write	Saving files and exiting the editor	4A-21 , 4A-142

Equation Editor Menu Display

Figure 4A-101 shows the general equation editor display. A description for each callout follows.

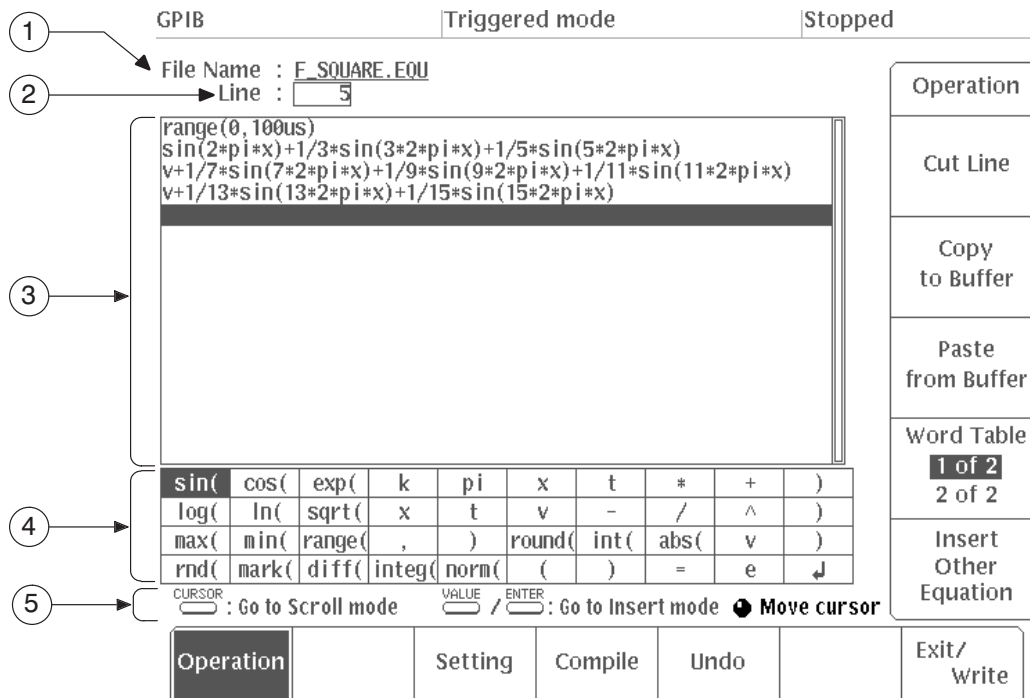

Figure 4A-101: Equation Editor CRT Display

(1) File Name

This is the name of the file being edited. If the file has not been named yet, the display is *******.EQU**.

(2) Line

This is the line number of the equation or range displayed inverted within the equation list.

(3) Equation List

An equation list contains two components: equations and a range for which the equations apply. The equation is input from the component menu, with the numeric keys or unit keys.

(4) Component Menu

The component menu contains the elements used to create an equation. The menu consists of two pages. The first page contains functions, operators, constants, variables and syntax items. The second page contains characters and symbols. These items are selected with the general purpose knob. Use **Word Table** under **Operation** to move between pages.

(5) Button Operation

This area shows how the front panel buttons operate in this menu.

 : Go to Cursor mode

When you press the **CURSOR** button, the line cursor within the inverted cursor in the equation list can be moved with the general purpose knob.

 /  : Go to Insert mode

When the **VALUE** or **ENTER** button is pressed, the system goes into a mode in which you can insert an item into the equation list from the component menu. Pressing the **VALUE** or **ENTER** button again shifts the state to **Insert word** described below.

 /  : Insert word

Pressing the **VALUE** or **ENTER** key inserts the item selected from the component menu into the equation list.

 : Go to Scroll mode

When you press the **CURSOR** button, the inverted cursor in the equation list can be moved with the general purpose knob.

 Move cursor

Turning the general purpose knob moves the line cursor in the equation list.

Creating and Editing Equation Files

Select **Operation** in the bottom menu to create or edit an equation file. When this item is selected, the time range can be designated with the component menu and the equation can be created. Figure 4A-102 shows a menu with **Operation** in the bottom menu selected.

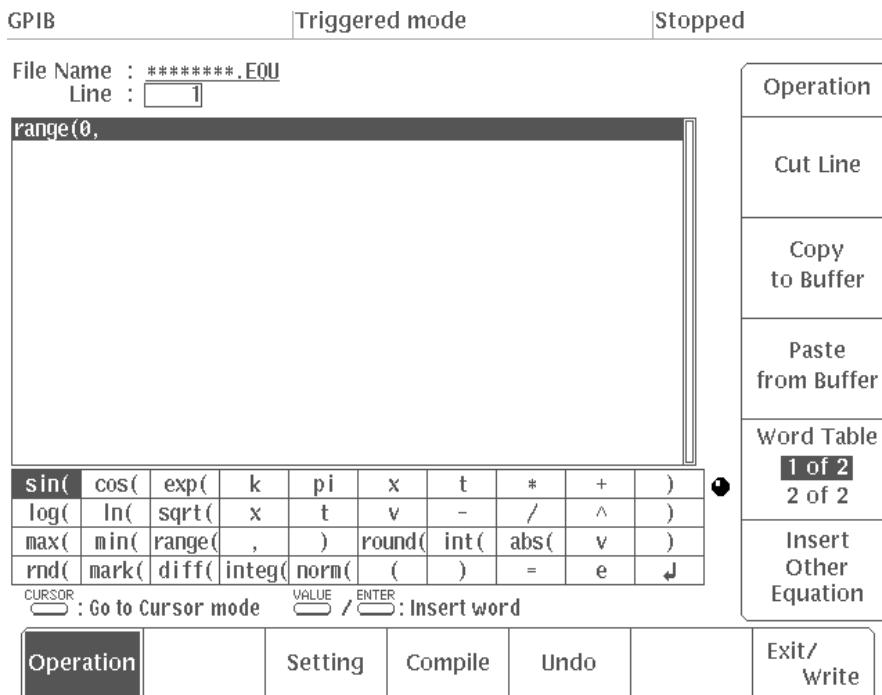

Figure 4A-102: Menu With Operation Selected

Creating an Equation

Specifying the Time Domain

The equation must specify the time domain. If the time domain is not defined, this is an error. The time domain is specified with **range()**.

When making a new equation file, **range(0,** is input in the first line of equation. Next, the time is specified. This setting is valid until the next **range()** item is specified. With the first **range()** specification, any number of lines of equation can be input. Text written after the **range()** on the same line is invalid. Here is the format for the **range()** item.

range(Equation starting time, Equation ending time)

Specification of subsequent time ranges use the component menu **range()** item. The clock frequency is obtained from the total time (period) set with **range()** and the waveform point count set with **Setting**, thus:

$$\text{Clock frequency} = \frac{\text{Waveform point count}}{\text{Equation period}}$$

Procedure

In this example, you will create a sine wave with a period of 1 ms, using the following equation:

range(0,1ms) Time range
sin(2*pi*x) Equation

- Step 1:** Select **Operation** from the bottom menu.
- Step 2:** After **range(0,** in the equation list, use the numeric keys and the unit keys to enter **1, ms**. The expression now reads **range(0,1ms)**.
- Step 3:** Using the general purpose knob, select **)** from the component menu.
- Step 4:** Press **VALUE** or **ENTER** on the front panel. The **)** that you selected in the component menu will be inserted in front of the position of the caret cursor, in the inverted line cursor in the equation list. The expression now reads **range(0,1ms)**.
- Step 5:** Press the **→** key. The inverted cursor will move to the next line.
- Step 6:** Using the general purpose knob, select **sin(** from the component menu.
- Step 7:** Press **VALUE** or **ENTER** on the front panel. The expression **sin(** will appear on the screen.
- Step 8:** Using the numeric keys, enter **2**. The expression now reads **sin(2**.
- Step 9:** Repeat steps 6 and 7 to enter *****, **pi**, *****, **x**, and **)**. The expression now reads **sin(2*pi*x)**.

Using the Front Panel Buttons in Editing

The **CURSOR** and **VALUE/ENTER** buttons are used to select the cursor, to enter a selected component, and to enter values with the numeric and unit keys. Here are details on these functions.

CURSOR Button – When you press the **CURSOR** button, you can move the inverted cursor and the caret cursor in the equation list with the general purpose knob. Each time you press the **CURSOR** button, the cursor that can be moved with the general purpose knob toggles between the inverted cursor and the caret cursor. The caret cursor can also be moved with the **«** and **»** keys on the front panel. While the inverted cursor can be moved with the general purpose knob, you can also move the inverted cursor directly to the desired line by using the numeric keys to enter the desired line number.

VALUE/ENTER Buttons – After the **CURSOR** button has been pressed, pressing the **VALUE** or **ENTER** button makes it possible to select an item with the general purpose knob from the component menu. In this state, pressing the **VALUE** or **ENTER** button again inserts the items selected into the equation list. At this time, input with the numeric and unit keys is also possible.

Decimal Point

When Option 09 is installed, all internal calculations use 32-bit floating point precision (IEEE 754 compatible). If Option 09 is not installed, 32-bit fixed precision is used when precision is not required (minimum unit 15µs or greater). When precision is required, 32-bit floating point precision (IEEE 754 compatible) is used.

For fast and highly precise calculations, we recommend that Option 09 be installed.

Component Menu

The component menu contains the items used to set the time range as well as functions, operators, variables, constants, syntax items and characters. You can use these items to create equations and enter comments.

To display the other page of the menu, press **Word Table** in the side menu under **Operation**. Figure 4A-103 shows the two pages of the component menu.

Word Table
1 of 2
2 of 2

Word Table
1 of 2
2 of 2

sin(cos(exp(k	pi	x	t	*	+)
log(ln(sqrt(x	t	v	-	/	^)
max(min(range(,)	round(int(abs(v)
rnd(mark(diff(integ(norm(()	=	e	↓

Word Table
1 of 2
2 of 2

#	a	b	c	d	e	f	g	h	i
j	k	l	m	n	o	p	q	r	s
t	u	v	w	x	y	z	%	\$	&
@	^	~	*	+	-	/	=	_	

Figure 4A-103: Component Menu

- Syntax Items

These are parentheses – (and) – for specifying the order of operations. Each opening (left) parenthesis must be paired with a closing (right) parenthesis. When there are two arguments – for example, **range, max, min** – they are separated with a , (comma).

- Variables

Here are the variables that can be used in an equation.

t : Time from the head of that **range()** statement.

x : Variable taking on a value from 0.0 to 1.0 within that **range()** statement.

v : Variable showing the current value of the waveform data at that position.

- Operators

+, −, *, /, ^

+, −, *, /

These add, subtract, multiply, or divide the components. The priorities are the same as usual for these four operators – * and / have priority over + and −.

^

Expresses exponents. Only integers can be raised to a higher power. ^ has the same priority as * and /. Therefore, parentheses are required to give priority to multiplication.

Example) **pi * (2 ^ 3) * x** where $2^3 =$ two raised to the third power.

- Comment

Comments are preceded by a number sign (#). When a number sign is entered, all characters after that until the end of the line are treated as a comment. All of the items in the component menu can be used in a comment.

- Characters

The characters available in the component menu are the letters of the alphabet (**a–z**) and several symbols (**%, \$, &, @, ~** and **_**). These are used in comments.

- Other items

pi, e, k, =, ↵

pi

The circumferential ratio.

e

Exponent (for an implied 10)

The range for numbers expressed in this scientific notation is from |5.9e−39| to |3.4e38|.

(Examples: **1e6**=1,000,000, **1e-3**=0.001)

k

The **k0-k9** can be specified; these are constants that may be used in equations. Specifying a new value for the same **k#** replaces the old value with the new one. If no constant is defined for **k**, this value will be automatically set to 0.

=

Equals sign. = is used with k constants.

Example: **k0=2*pi**

↵

Ends the line for the range or equation; inserting a return (↵) in the middle of the line partitions it.

- Functions

Here are the functions that make up the equation.

- **sin(, cos(** — The arguments for these trigonometric functions are in radians.

Example: range(0,100 μs)
cos(2*pi*x)

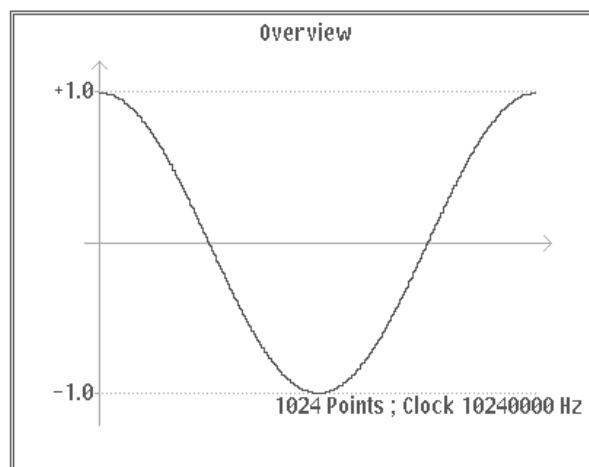

Figure 4A-104: Trigonometric Function Waveform Expressed With Variable x

Example: range(0,100 μ s)
 $\sin(2*\pi*1e4*t)$

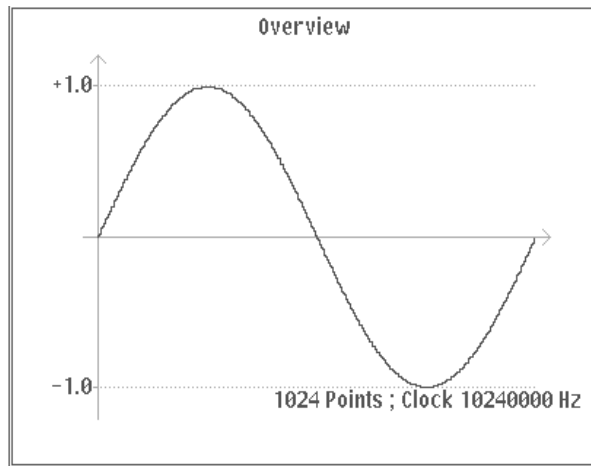

Figure 4A-105: Trigonometric Function Waveform Expressed With Variable t

- **exp(), log(), ln()**
Exponential function, common log function, natural log function.
The log and ln arguments must be positive.

Example: range(0,50 μ s)
 $1 - \exp(-5*x)$
range(50 μ s,100 μ s)
 $\exp(-5*x)$

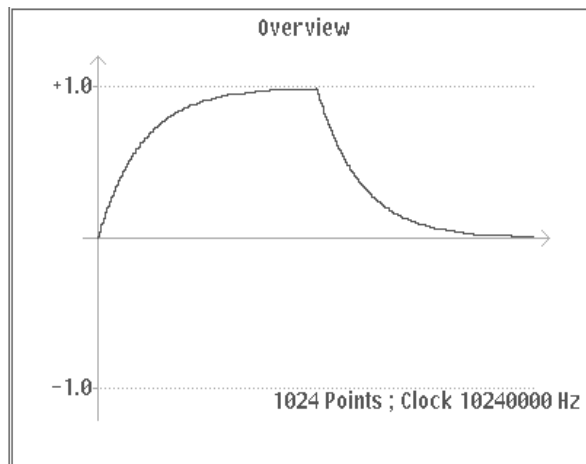

Figure 4A-106: Equation Using exp()

Example: range(0,100 μ s)
 $\log(10*(x+0.1))$

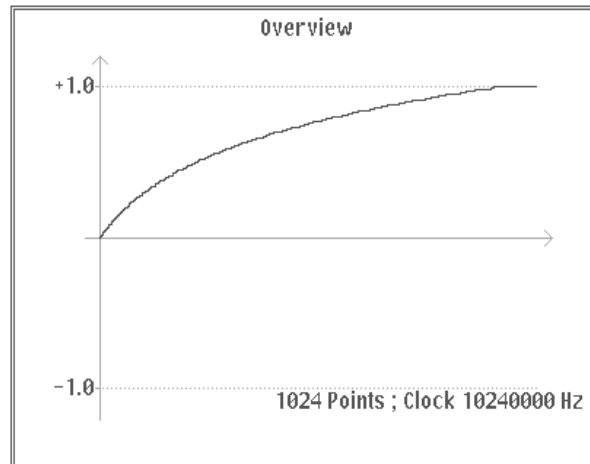

Figure 4A-107: Equation Using log(

Example: range(0,100 μ s)
 $\ln(2*(x+0.2))$

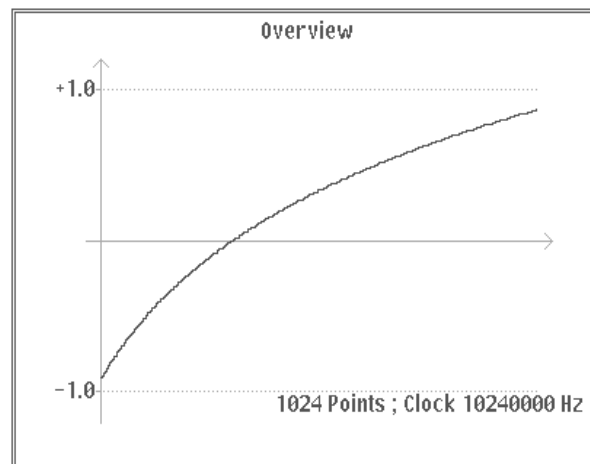

Figure 4A-108: Equation Using ln(

■ **sqrt(**

The square root; the argument must be a positive value.

Example: range(0,100 μ s)
sqrt(sin(pi*x))

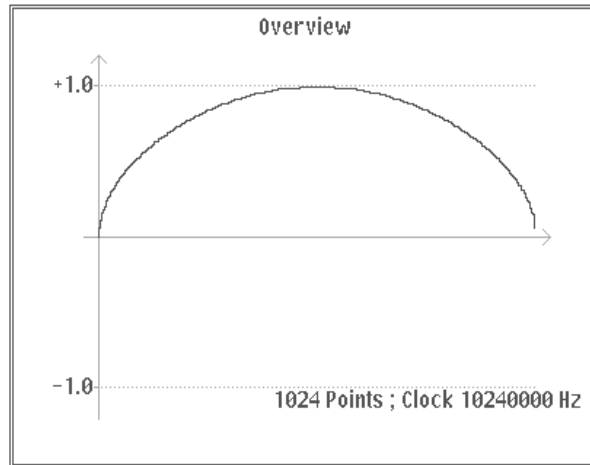

Figure 4A-109: Equation Using sqrt(

■ **abs(**

The absolute value.

Example: range(0,100 μ s)
abs(sin(2*pi*x))

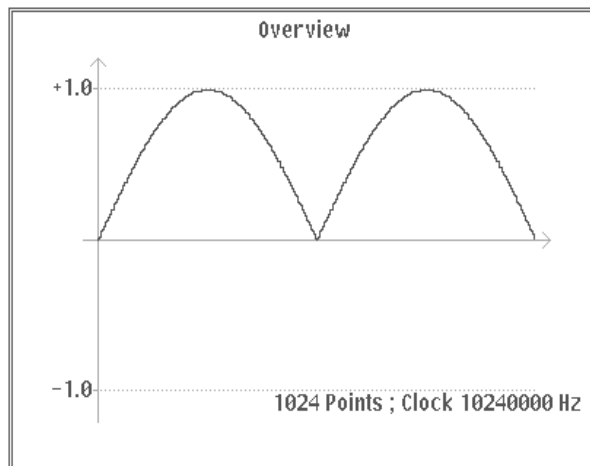

Figure 4A-110: Equation Using abs(

- **int()**
 Truncates the fraction to obtain the integer.

Example: range(0,100 μ s)
 $\text{int}(5*\sin(2*\pi*x))/5$

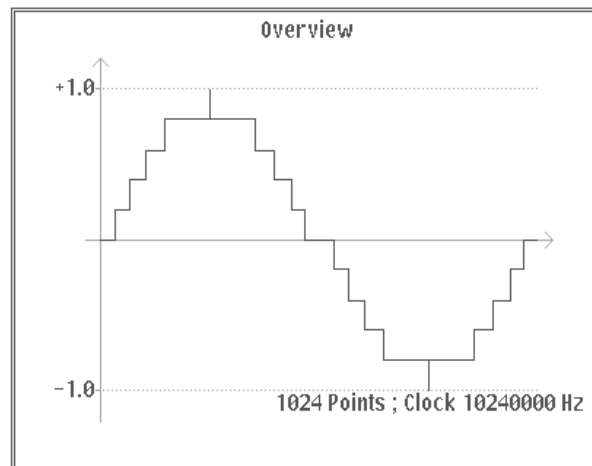

Figure 4A-111: Equation Using int()

- **round()**
 Rounds off the fraction to obtain the integer.

Example: range(0,100 μ s)
 $\text{round}(5*\sin(2*\pi*x))/5$

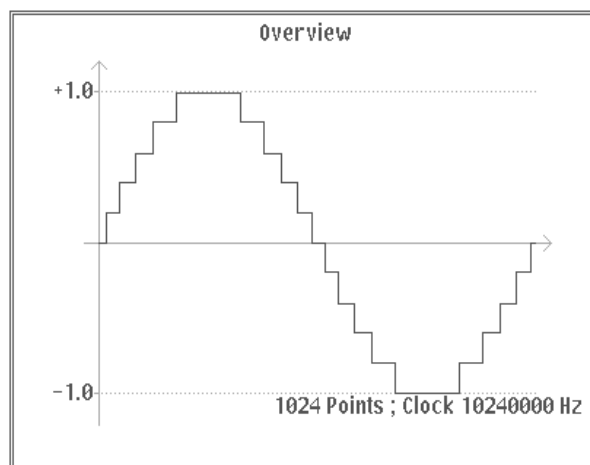

Figure 4A-112: Equation Using round()

- norm()**
 Normalizes the range specified with range() and scales the amplitude values so that the maximum absolute value is 1.0 (i.e. a value of +1.0 or -1.0). The **norm()** statement comprises an entire line.

Example: range(0,100 μs)
 sin(2*pi*x)+rnd()/10
 norm()

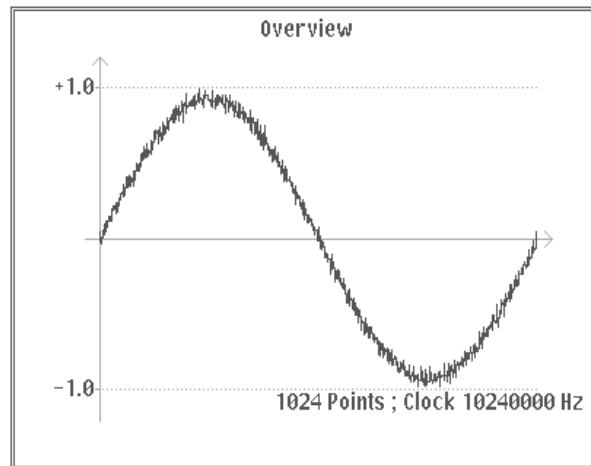

Figure 4A-113: Equation Using norm()

- max()** — Takes the larger of two values.
- min()** — Takes the smaller of two values.

Example: range(0,100 μs)
 sin(2*pi*x)
 range(0,50μs)
 min(v,0.5)
 range(50μs,100μs)
 max(v,-0.5)

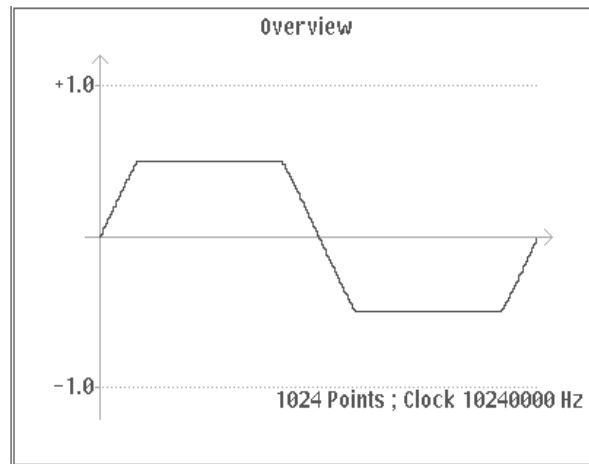

Figure 4A-114: Equation Using max(and min(

- **rnd** (integer from 1 to 16777215)
 When an argument is specified, generates a random number sequence using that argument as the initial value. If the argument is omitted, 1 is used.

Example: `range(0,100 μs)`
`rnd(2)/3`

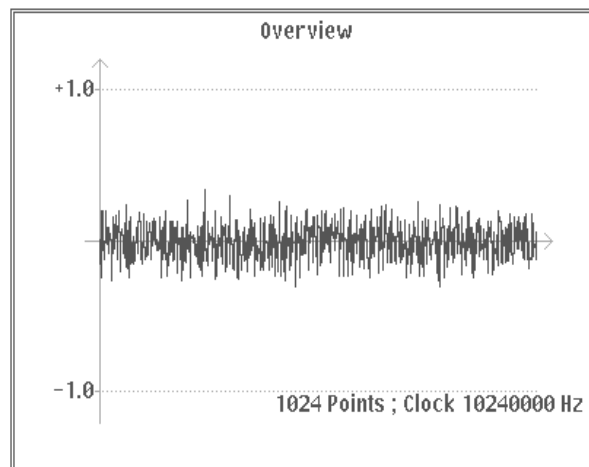

Figure 4A-115: Equation Using rnd(

See "Random Function" in Appendix D for a discussion of the algorithms for **rnd** functions.

- diff()**
 Differentiates the function over the range specified with **range()**. Specified with **diff()**. The **diff()** comprises an entire line.

Example: range(0,25 μ s)
 -0.5
 range(33 μ s,66 μ s)
 0.5
 range(66 μ s,100 μ s)
 -0.5
 range(0,100 μ s)
 diff()

Differentiating the waveform in Figure 4A-116 gives the waveform shown in Figure 4A-117.

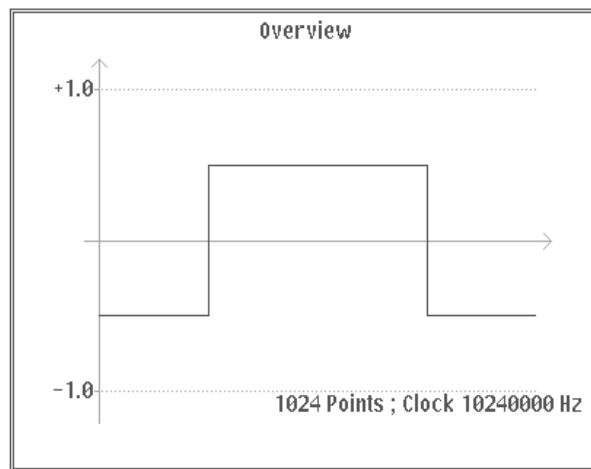

Figure 4A-116: Waveform Before Calculation

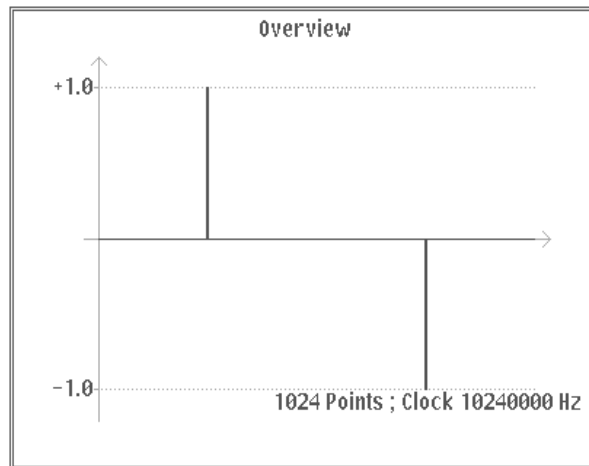

Figure 4A-117: Waveform After Differentiation Using diff()

See "Differentiation" in Appendix D for a discussion of the algorithms for **diff** functions.

- integ()**
 Integrates the function over the range specified with **range()**. Specified with **integ()**. The **integ()** comprises an entire line. After **integ()**, specify normalization (**norm()**) as necessary.

```

Example: range(0,25 μs)
        -0.5
        range(33μs,66μs)
        0.5
        range(66μs,100μs)
        -0.5
        range(0,100μs)
        integ()
        norm()
  
```

Figure 4A-116 shows the waveform before integration. Figure 4A-118 shows the waveform after integration.

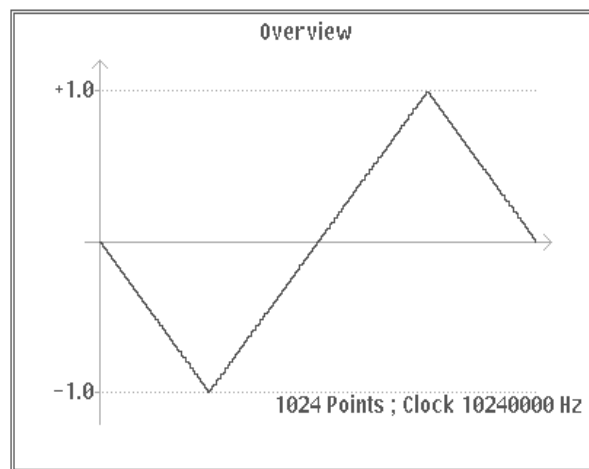

Figure 4A-118: Waveform After Integration Using integ()

See "Integration" in Appendix D for a discussion of the algorithms for **integ** functions.

- mark (MARKER 1)**
 Sets the marker for the range set with **range()**. After compiling, there is no marker display, but the set marker can be verified with the waveform editor. The **mark()** statement comprises an entire line. For example, when **mark(1)** is input, nothing else can be input on that line.

Operation

Editing Functions

When you select **Operation** in the bottom menu, the following items appear in the side menu:

- **Cut Line**
- **Copy to Buffer**
- **Paste from Buffer**
- **Word Table**
- **Insert Other Equation**

Cut Line

Cutting a line

Use **Cut Line** to cut out a line in the equation list.

Procedure

- Step 1:** Select **Operation** from the bottom menu.
- Step 2:** Pressing the **CURSOR** button on the front panel twice puts the system into scroll mode. Pressing the **CURSOR** button toggles the unit between cursor mode and scroll mode.

Cursor mode — Line cursor moves between items in the equation list, item by item.

Scroll mode — A inverted line cursor moves through the lines in the equation list, line by line.

- Step 3:** Use the general purpose knob to move the displayed inverted cursor to the line to be deleted from the created equation list.
- Step 4:** Select **Cut Line** from the side menu.

When **Cut Line** is selected, the line displayed inverted in the equation list is deleted. The deleted line is placed in the paste buffer. To restore this line to its original state, select **Undo** from the bottom menu or **Paste from Buffer** from the side menu.

Copy
to Buffer

Paste
from Buffer

Copying and Pasting a Line

Use the **Copy to Buffer** and **Paste from Buffer** items to copy a line in the equation list and paste it to another line.

Procedure

- Step 1:** Use the same procedure as described in Cutting a Line to line up the inverted display cursor with the line to be copied.
- Step 2:** Select **Copy to Buffer** from the side menu.

When **Copy to Buffer** is selected, the line displayed inverted in the equation list is placed in the paste buffer. This item has no effect on the CRT display.

- Step 3:** Use the general purpose knob to specify the position to paste the copied line with the inverted display cursor. The position for pasting is directly before the inverted display cursor in the equation list.
- Step 4:** Select **Paste from Buffer** from the side menu.

Insert
Other
Equation

Insert Other Equation File

Use **Insert Other Equation** to select an equation file from internal memory (see Figure 4A-119). An equation file is inserted from this list into the equation list.

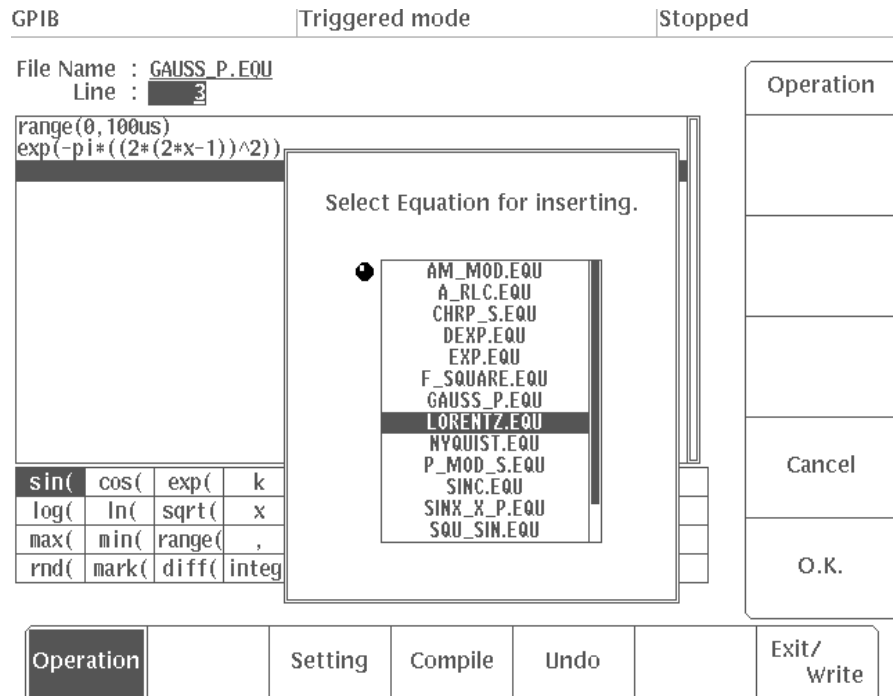

Figure 4A-119: Menu Displayed When Insert Other Equation is Selected

Procedure

- Step 1:** Use the same procedure as described in "Cutting a Line" to line up the inverted display cursor with the line where the other equation file is to be inserted.
- Step 2:** Select **Insert Other Equation** from the side menu.
- Step 3:** Use the general purpose knob to select the equation file to be inserted.
- Step 4:** After selecting the file, press the **O.K.** side menu button to insert the selected file directly before the inverted cursor within the equation list. Press the **Cancel** side menu button to cancel the selection and return the system to the equation editor.

Setting

Setting Waveform Point Count

When **Setting** is selected from the bottom menu, the number of waveform points for equation file compilation and waveform file creation can be set. Figure 4A-120 shows the menu for when **Setting** is selected.

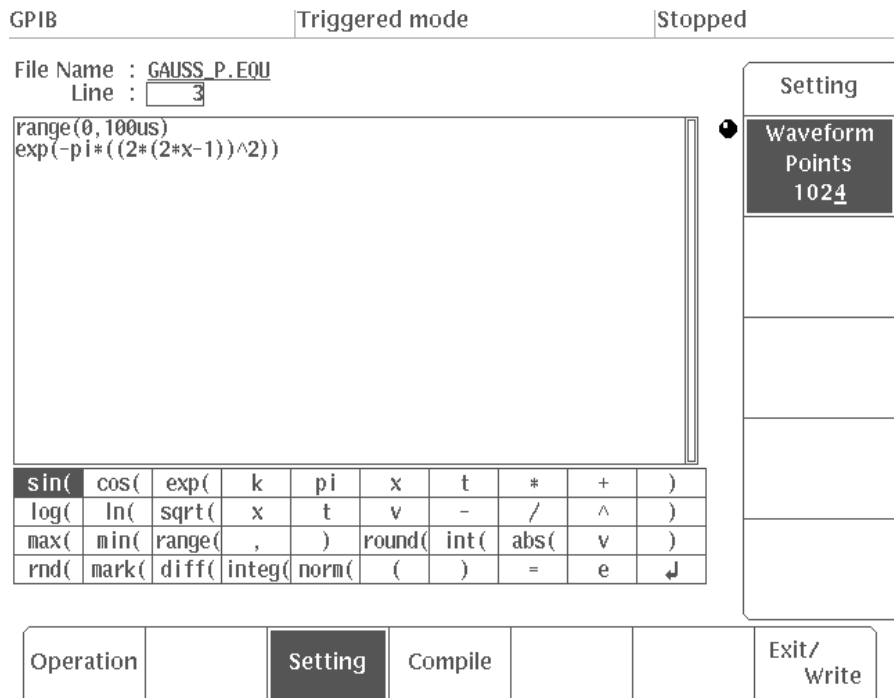

Figure 4A-120: Setting Waveform Point Size

Waveform Points

Procedure

- Step 1:** Select **Setting** from the bottom menu.
- Step 2:** Use the numeric keys or the general purpose knob to set the number of waveform points.

The default value for the waveform point count is 1024. The waveform point count can be set to any value between 1 and 32 K. However, when the setting causes the calculated clock frequency to be greater than 1.024 GHz, the clock frequency will be held to the maximum frequency of 1.024 GHz. When the calculated clock frequency is less than 1 kHz, it will be held to the minimum frequency of 1 kHz. The following message will appear, asking you to confirm that this is all right. If it is, select **O.K.** from the side menu. In such cases, the waveform period is different from the value designated with **range()**; it is equivalent to the clock period multiplied by the waveform point count.

The clock calculated (xxxxx Hz) is not supported by this instrument. The waveform will be output with the maximum clock of 1.024e+09Hz.

Clock frequency = more than 1.024 GHz

The clock calculated (xxxxx Hz) is not supported by this instrument. The waveform will be output with the minimum clock of 1000Hz.

Clock frequency = less than 1 kHz

Compile

Compiling Equations into Waveform Data

Use the **Compile** item to convert the assembled equation into waveform data and to create a waveform file. This waveform file is given the same name as the equation file it was compiled from.

Procedure

Here is the procedure for compiling the equation to make a waveform file.

- Step 1:** Select **Compile** from the bottom menu. The equation is compiled.

The Busy icon is displayed on the status line of the CRT display to show that the compilation is being processed. **Cancel** is displayed in the count menu. Selecting this item cancels the compilation.

- Step 2:** The equation is converted into waveform data and the waveform is displayed. Along with the waveform, the set waveform point count and clock frequency are displayed. Figure 4A-121 is an example of the display of a compiled waveform.

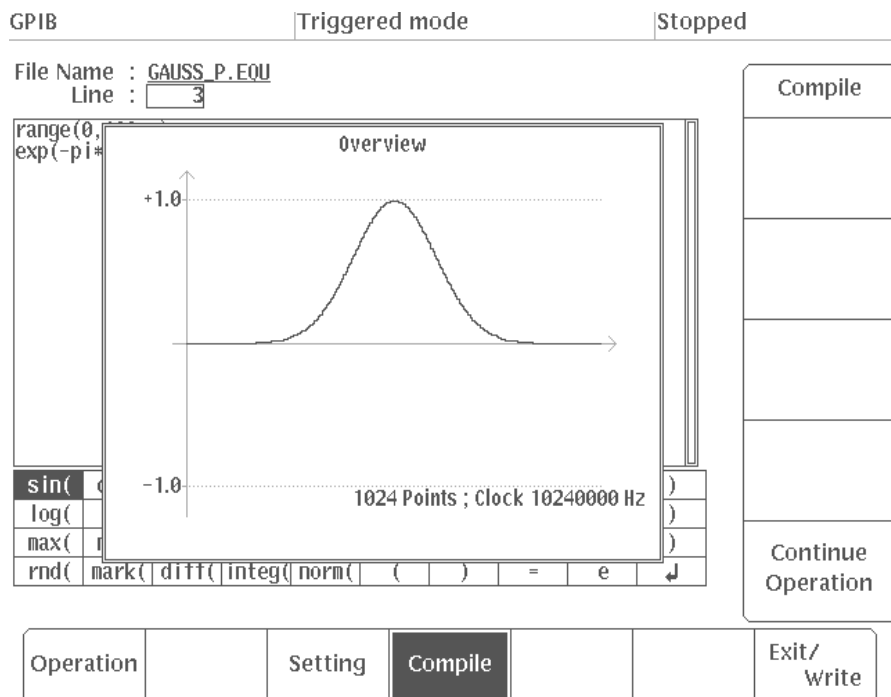

Figure 4A-121: Example of Compiled Waveform Display

- Step 3:** Verify the waveform, then select **Continue Operation** from the side menu. The display returns to the equation editor.

When an error is detected, an error message is displayed at the top of the screen at high intensity and the inverted display cursor is moved to the equation or time domain with the syntactical error. In this case, correct the error as instructed by the message, and then compile again.



The compiled waveform file contains the settings for the waveform point count (set with **Setting**) and the clock frequency (obtained from the total time set with the **range** item.) Other output parameters are set to the default values.

The compiled waveform also has a vertical axis on which -1.0 is data value 0 and $+1.0$ is data value 254. There is no relation between these values and the actual output voltage.

Sequence Editor

Use the sequence editor to edit files with the extension of **.SEQ**. Sequence files assemble a number of waveforms or sequence files in order. The file data contains waveform file names in sequence, their repetition counts, and the sequence waveform output parameters.

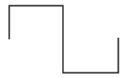
Figure 4A-122 shows an example of the data in a sequence file and the waveform display for that data.

Sequence File		
File name	Number of repetitions	Waveform
WAVE-1.WFM	2	
WAVE-2.WFM	1	
WAVE-3.WFM	2	

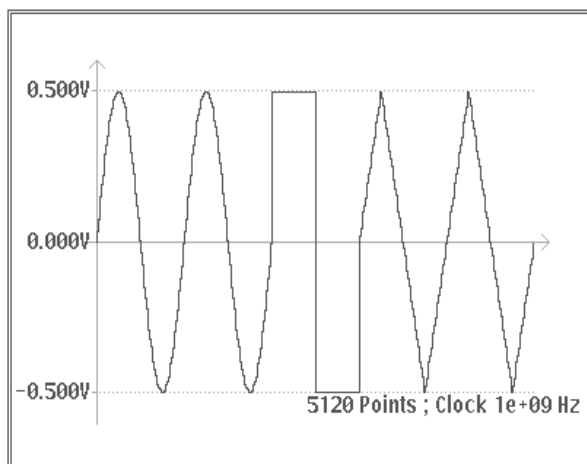

Figure 4A-122: Sequence File Data and Sample Waveform Display



Entering the Sequence Editor

Procedure

Step 1: Press the **EDIT** button in the **MENU** column. The initial **EDIT** menu will appear.

Step 2: Select **Edit** or **New Sequence** from the side menu.

Edit — Used to select and edit an existing sequence file (**.SEQ**)

New Sequence — Used to create a new sequence file

The sequence editor screen will appear.

Saving Files and Exiting the Editor

Use **Exit/Write** in the bottom menu to save the file to the internal memory of the AWG2041 and exit from the editor depending on the selected side menu item.

The same procedure is used to save the file and exit from the equation editor as for the waveform editor. See "Saving Files and Exiting the Editor" in the section on the waveform editor.

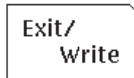

Sequence Editor Menu Structure

The Sequence Editor menu has the structure shown in Figure 4A-123.

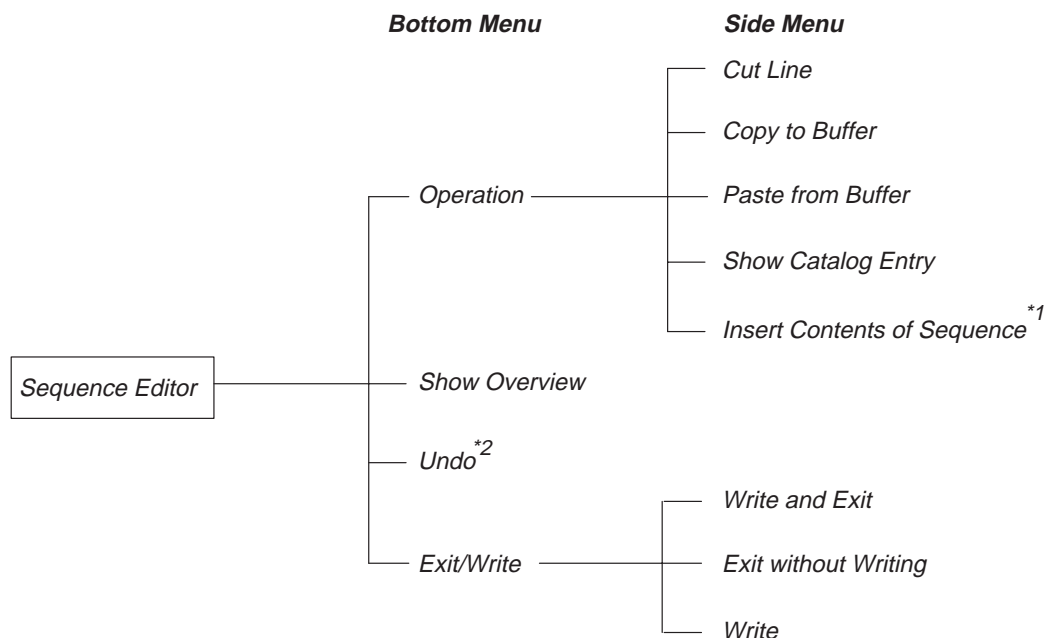

Figure 4A-123: Sequence Editor Menu Structure

*1 This item appears in the side menu when a sequence file (**XXX.SEQ**) has been selected with **Catalog** in the menu.

*2 This item appears when **Operation** in the bottom menu has been selected.

Menu Functions

The following list shows the functions available for each menu item and the page on which you can find a description of that function.

Table 4A-7: Menu Functions

Menu	Function	Page
Operation	Editing functions	4A-172
Cut Line	Cutting a line	4A-172
Copy to Buffer	Copying a line	4A-172
Paste from Buffer	Pasting a line	4A-172
Show Catalog Entry	Catalog file waveform display	4A-173
Insert Contents of Sequence	Inserting a sequence file	4A-174
Show Overview	Sequence file display	4A-175
Undo	Undoing the previous operation	4-2
Exit/Write	Saving files and exiting the sequence editor	4A-21 , 4A-166

Sequence Editor Menu Display

Figure 4A-124 shows the general sequence editor display. A description for each callout follows.

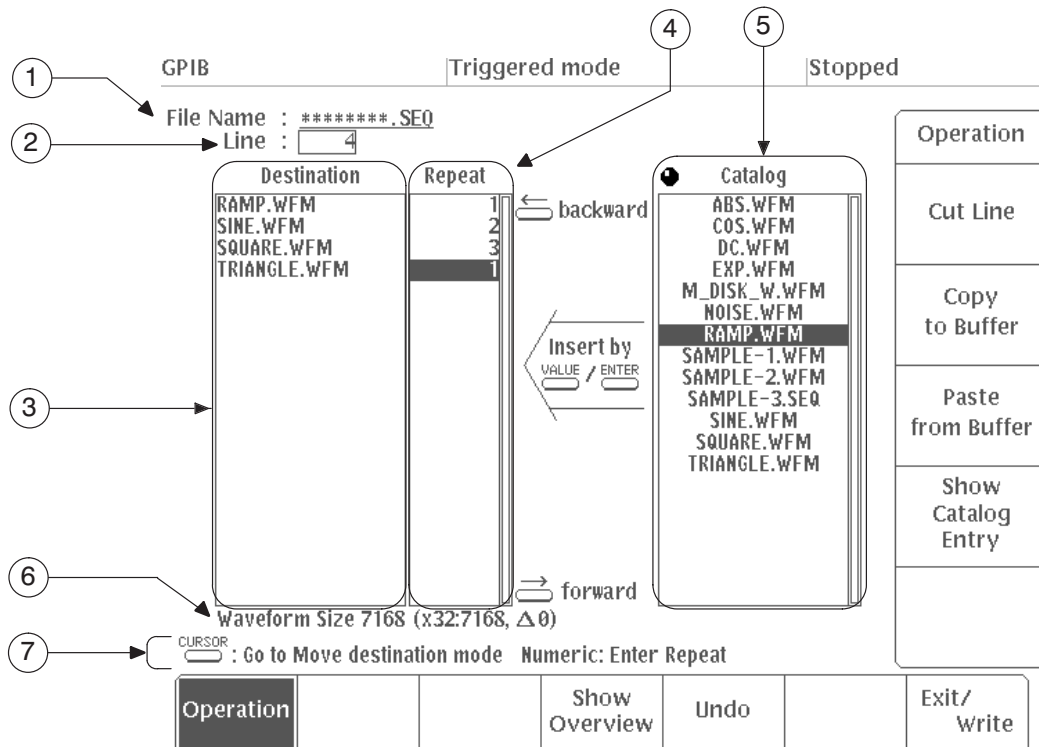

Figure 4A-124: Sequence Editor CRT Display

(1) File Name

The name of the sequence file being edited; if the name has not been set yet, *******.SEQ** is displayed.

(2) Line

The line number displayed inverted in the **Destination** list or **Repeat** column.

(3) Destination

List of the waveform or sequence files included in the sequence file being edited.

(4) Repeat

The repetition count for the file in (3), above. The waveform or sequence file is repeated the specified number of times. This number can be set to any value that the total number of points of the files making up the sequence are up to a maximum of 1M (or 4M when Option 01 is installed). For example, for a sequence containing only 1024-point waveform files, the total of the values in the **Repeat** column can be set anywhere up to 1024.

(5) Catalog

List of the waveform or sequence files in internal memory; a sequence file is created by selecting files from this list.

(6) Waveform Size (x32: , Δ)

This item is displayed only when the hardware sequencer is off.

Waveform Size **** — The total number of points in the waveforms included in the sequence file being edited. This will depend on the size of the files in the list and the value set for **Repeat**.

x32: **** — The point size when the total waveform point count is expanded to form a multiple of 32.

Δ ** — The number of additional points needed when expanding the total waveform point count to form a multiple of 32.

(7) Button Operations

This area shows how the front panel buttons operate in this menu.

CURSOR
 : Go to Move destination mode

When you press the **CURSOR** button, you can scroll through the files in the **Destination** list or **Repeat** column with the general purpose knob.

Numeric: Enter Repeat

The repetition count is set with the numeric keys. Pressing the **VALUE** or **ENTER** button enters the input value into the **Repeat** column.

VALUE / ENTER
 /  : Go to Insert mode

Pressing the **VALUE** or **ENTER** button puts the system into insert mode. In this mode, files can be selected from the **Catalog** and the selected files can be inserted into the **Destination** list.



Pressing the **VALUE** or **ENTER** button inserts the file that is displayed inverted within the **Catalog** directly before the inverted display cursor in the **Destination** list.

← backward

Pressing the « button moves the inverted cursor left or up one step in the **Destination** list or **Repeat** column.

→ forward

Pressing the → button moves the inverted cursor right or down one step in the **Destination** list or **Repeat** column.

Creating and Editing Sequence Files

Select **Operation** in the bottom menu to create or edit a sequence file. After you have done this, you can select a waveform or sequence file from **Catalog** and then put together a sequence and set the number of repetitions for that file to create the sequence file.

Creating a Sequence File

In this example you will create a new sequence file.

- Step 1:** Select **Operation** from the bottom menu.
- Step 2:** Use the general purpose knob to select the file from the **Catalog** to insert into the **Destination** list.
- Step 3:** Press the **VALUE** button or **ENTER** button on the front panel. The file selected from the **Catalog** is inserted into the **Destination** list. The file being inserted is placed directly before the inverted display cursor. When the file is inserted, the inverted cursor will move to **Repeat** on the same line.
- Step 4:** Use the numeric keys to input the repetition count, then press the **ENTER** button to enter the value. The inverted cursor will move to **Destination** on the next line.

The default value for repetition counts is 1. If there is no need to change this value, press the → button. The inverted cursor will move to **Destination** on the next line.
- Step 5:** Repeat steps from 2 to 4 to create the desired sequence. The programmable sequence length may be up to the waveform memory size (4M words when Option 01 is installed).

Figure 4A-125 shows an example of sequence creation.

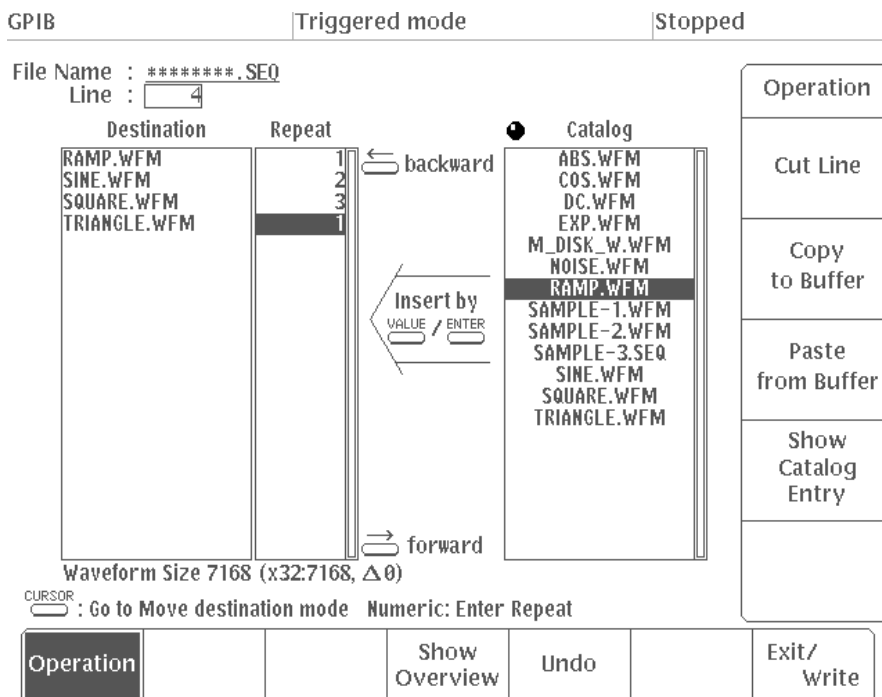

Figure 4A-125: Sequence File Creation Example

Button Functions

To select files within the **Destination** list, press the **CURSOR** button, then select with the general purpose knob or numeric keys. When the numeric keys are used, input the specified line number in the **Line** input column at the top left of the CRT screen. Pressing the **VALUE** or **ENTER** button enters this line number and moves the inverted display cursor to the specified line number.

When the **CURSOR** button has been pressed, if the **VALUE** button or **ENTER** button is pressed, the system goes into Insert mode. Pressing either of these buttons again inserts the file selected from the **Catalog** into the **Destination** list.

Pressing the → button causes the inverted cursor to move to the right or downward. Pressing the ← button causes the inverted cursor to move to the left or upward.

Operation

Editing Functions

When you select **Operation** in the bottom menu, the following items appear in the side menu:

- **Cut Line**
- **Copy to Buffer**
- **Paste from Buffer**
- **Show Catalog Entry**
- **Insert Contents of Sequence**
(Appears when a sequence file has been selected with **Catalog**)

Cut Line

Cutting a Line

Use **Cut Line** to cut out a line in the **Destination** list.

Procedure

- Step 1:** Select **Operation** from the bottom menu.
- Step 2:** Press the **CURS** button on the front panel.
- Step 3:** Use the general purpose knob to select the line to be cut from the **Destination** list.
- Step 4:** Select **Cut Line** from the side menu.

When **Cut Line** is selected, the line displayed inverted in the **Destination** list is deleted. This deleted line is put into the paste buffer. To return the **Destination** list to its original state, select **Undo** from the bottom menu or **Paste from Buffer** from the side menu.

Copy
to Buffer

Paste
from Buffer

Copying and Pasting a Line

Use **Copy to Buffer** and **Paste from Buffer** items to copy a line in the **Destination** list and paste it to another line.

Procedure

- Step 1:** Select **Operation** from the bottom menu.
- Step 2:** Press the **CURS** button on the front panel. Use the general purpose knob to select the line to copy from the **Destination** list.
- Step 3:** Select **Copy to Buffer** from the side menu.

When **Copy to Buffer** is selected, the line displayed inverted in the **Destination** list is copied into the paste buffer. This operation does not affect the display on the CRT.

- Step 4:** Use the general purpose knob to specify the position to paste the copied line with the inverted display cursor. The position for pasting is directly before the inverted display cursor in the **Destination** list.

Show
Catalog
Entry

- Step 5:** Select **Paste from Buffer** from the side menu.

Each time **Paste from Buffer** is selected, the line copied into the paste buffer with the copy processing are pasted into whatever line you want.

Catalog File Waveform Display

Use this item to observe the waveforms of the files being assembled into the sequence.

Procedure

- Step 1:** Select **Operation** from the bottom menu.
- Step 2:** Use the general purpose knob to select the file you want to observe from the **Catalog**.
- Step 3:** Select **Show Catalog Entry** from the side menu.

The waveform is displayed and the file name, the vertical axis voltage, the waveform point count, and the clock frequency data are shown.

Figure 4A-126 is an example of waveform display for when **Show Catalog Entry** is selected.

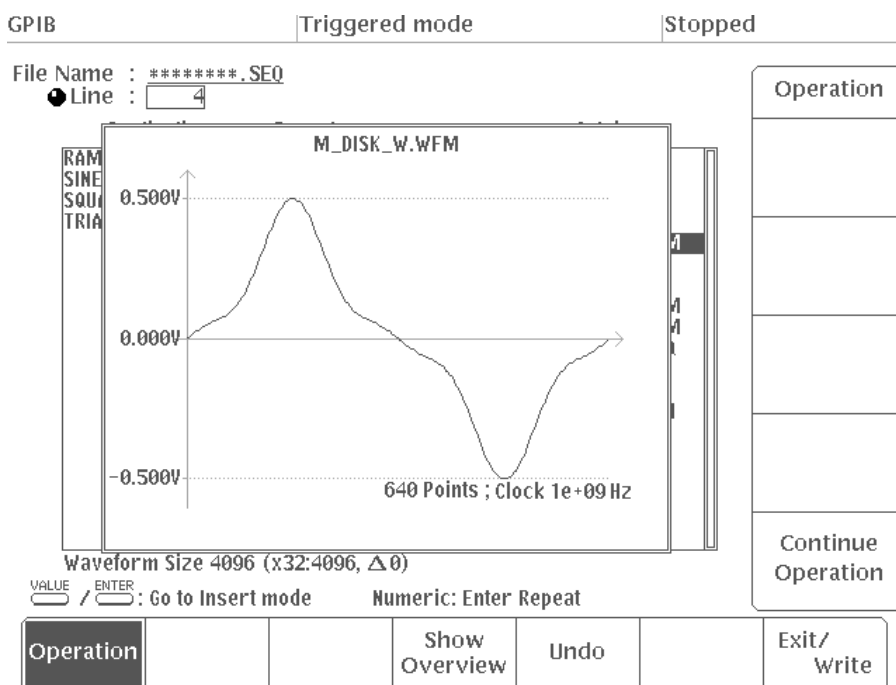

Figure 4A-126: Example of Waveform Display When Show Catalog Entry is Selected

- Step 4:** After observing the waveform, select **Continue Operation** from the sub menu to return to the sequence editor.

Insert Contents of Sequence

Inserting a Sequence File

Select a sequence file in the **Catalog** to display the **Insert Contents of Sequence** item in the side menu. When this item is selected, the contents of the sequence file are developed and inserted into the **Destination** list.

NOTE. When creating sequence file, you cannot use as sources sequence files that contain other sequence file. If you try to do this, a message will be displayed telling you that you cannot. In this case, you can use the **Insert Contents of Sequence** item to develop the sequence and insert it.

Procedure

- Step 1:** Select **Operation** from the bottom menu.
- Step 2:** Press the **CURSOR** button on the front panel.
- Step 3:** Use the general purpose knob to select the line where the developed sequence file is to be inserted from the **Destination** list. The developed file is inserted directly before the inverted display cursor in the **Destination** list.
- Step 4:** Press the **VALUE** button on the front panel.
- Step 5:** Use the general purpose knob to select the sequence file from the **Catalog**. The **Insert Contents of Sequence** item will appear in the side menu.
- Step 6:** Select **Insert Contents of Sequence** from the side menu.

The contents of the selected sequence file are inserted directly before the inverted display cursor in the **Destination** list.

Show
Overview

Sequence File Display

Use **Show Overview** from the bottom menu to display the waveform for the created or edited sequence file.

Procedure

- Step 1:** Select **Show Overview** from the bottom menu.

The waveform will be displayed, together with such information as the voltage indicated by the vertical axis, the waveform point count and the clock frequency. Figure 4A-127 shows an example of a waveform display with the **Show Overview** item selected.

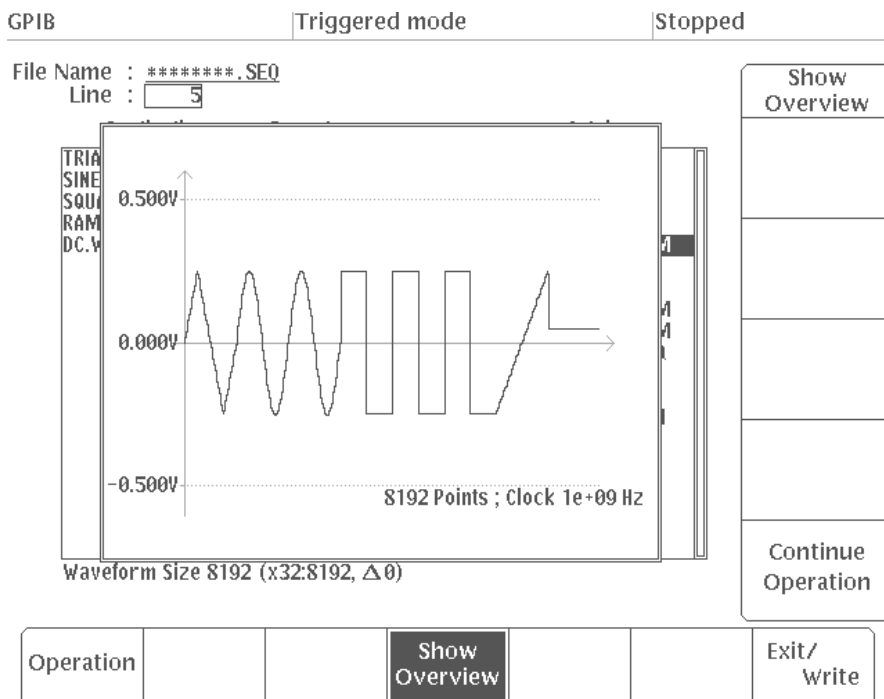





Figure 4A-127: Example of CRT Display When Show Overview is Selected

- Step 2:** After observing the waveform, select **Continue Operation** from the side menu to return to the sequence editor.

Autostep Editor

Use the autostep editor to edit files with the extension of .AST. Autostep files are created by programming waveforms or sequence files.

Files created with the autostep editor are started up using **Autostep** in the **MODE** menu. Each time an autostep signal is received, the waveform changes to the next waveform in line with the program. The waveform is output when a trigger signal is received. Each waveform or sequence file contains the output conditions that have been set for that file, so the output conditions can be changed for each waveform. At this point of time, it is not possible to change the output parameters in the **SETUP** menu. Figure 4A-128 shows an example of the data and output waveform for an autostep file.

Autostep File			
Step	File Name	Output Conditions	Waveform
1	SIN-1.WFM	Amplitude 2 V Offset 0 V	
2	SQUARE.WFM	Amplitude 1 V Offset 0 V	
3	RAMP.WFM	Amplitude 1 V Offset 0.5 V	

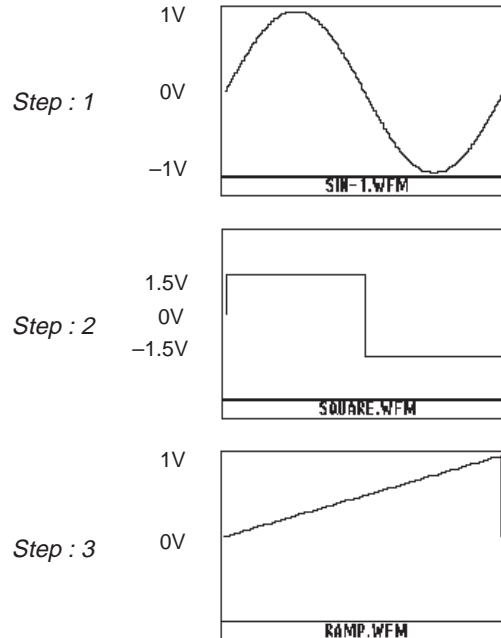
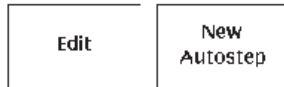

Figure 4A-128: Autostep File Data and Output Waveforms



Entering the Autostep Editor

Procedure

- Step 1:** Press the **EDIT** button in the **MENU** column. The initial **EDIT** menu will appear.
- Step 2:** Select **More** from the side menu to display the second page of the side menu : **More 2 of 2**
- Step 3:** Select **Edit** or **New Autostep** from the side menu.

Edit — Used to select and edit an existing autostep file (.AST)

New Autostep — Used to create a new autostep file

The autostep editor screen will appear.

Saving Files and Exiting the Editor

Select **Exit/Write** from the bottom menu in the autostep editor to save the file (which you have either created or edited) to the internal memory of the AWG2041 and exit from the editor depending on the selected side menu item.

The same procedure is used to save the file and exit from the autostep editor as for the waveform editor. See "Saving Files and Exiting the Editor" in the section on the waveform editor.

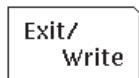

Autostep Editor Menu Structure

The Autostep Editor menu has the structure shown in Figure 4A-129.

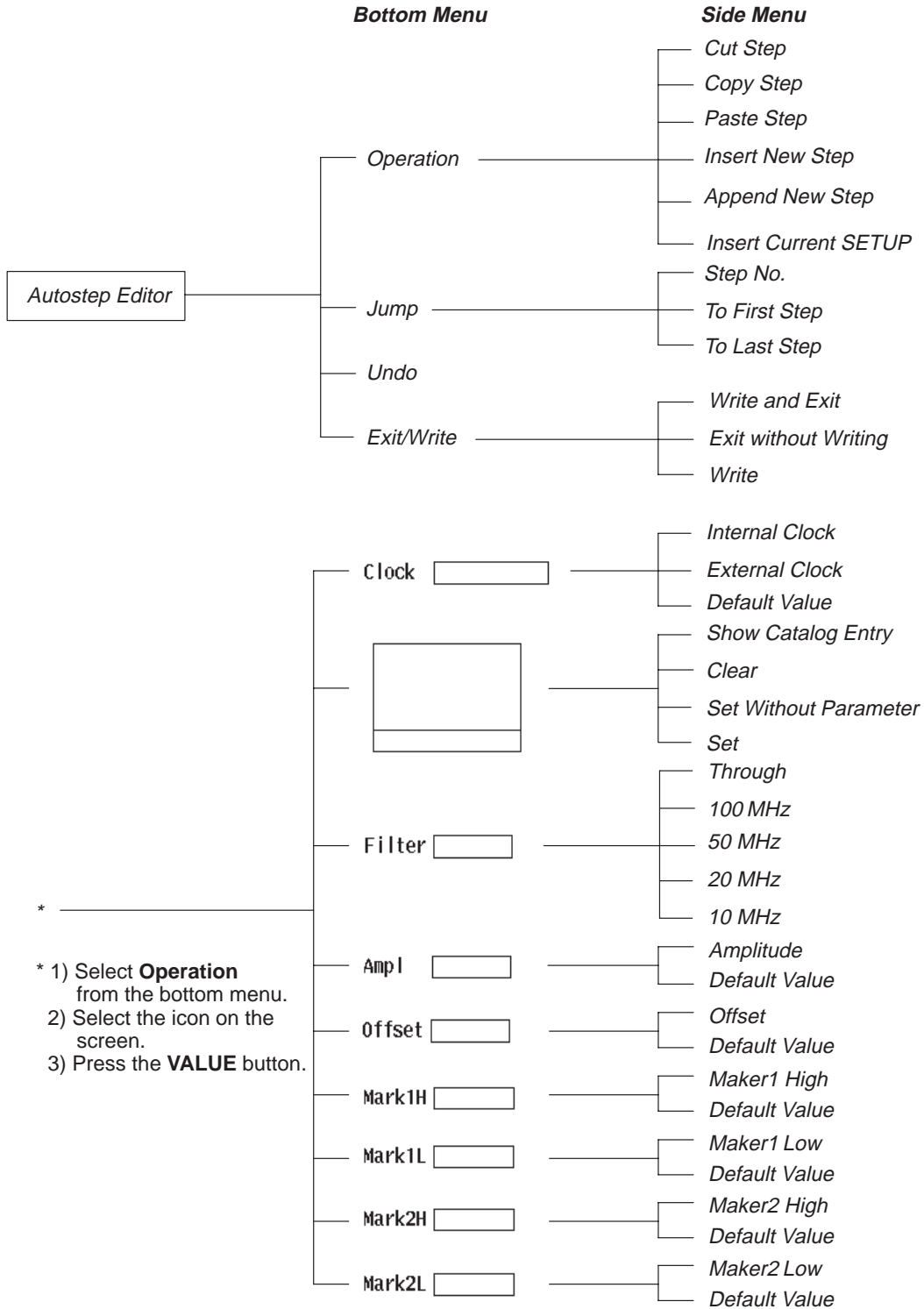

Figure 4A-129: Autostep Editor Menu Structure

Menu Functions

The following list shows the functions available for each menu item and the page on which you can find a description of that function.

Table 4A-8: Menu Functions

Menu	Function	Page
Operation	Editing functions	4A-190
Cut Step	Cutting a step	4A-190
Copy Step	Copying a step	4A-190
Paste Step	Pasting a step	4A-190
Insert New Step	Adding a step	4A-191
Append New Step	Adding a step	4A-191
Insert Current SETUP	Inserting the SETUP menu waveforms and output parameters	4A-191
Jump	Jumping to a step	4A-191
Undo	Undoing the previous operation	4-2
Exit/Write	Saving files and exiting the editor	4A-21
Items selected on the screen		
Clock	Clock settings	4A-185
Waveform/Sequence	Setting files	4A-182
Filter	Filter settings	4A-186
Amplitude	Amplitude settings	4A-187
Offset	Offset settings	4A-188
Marker	Marker settings	4A-189

Autostep Editor Menu Display

Figure 4A-130 shows the general autostep editor display. A description for each callout follows.

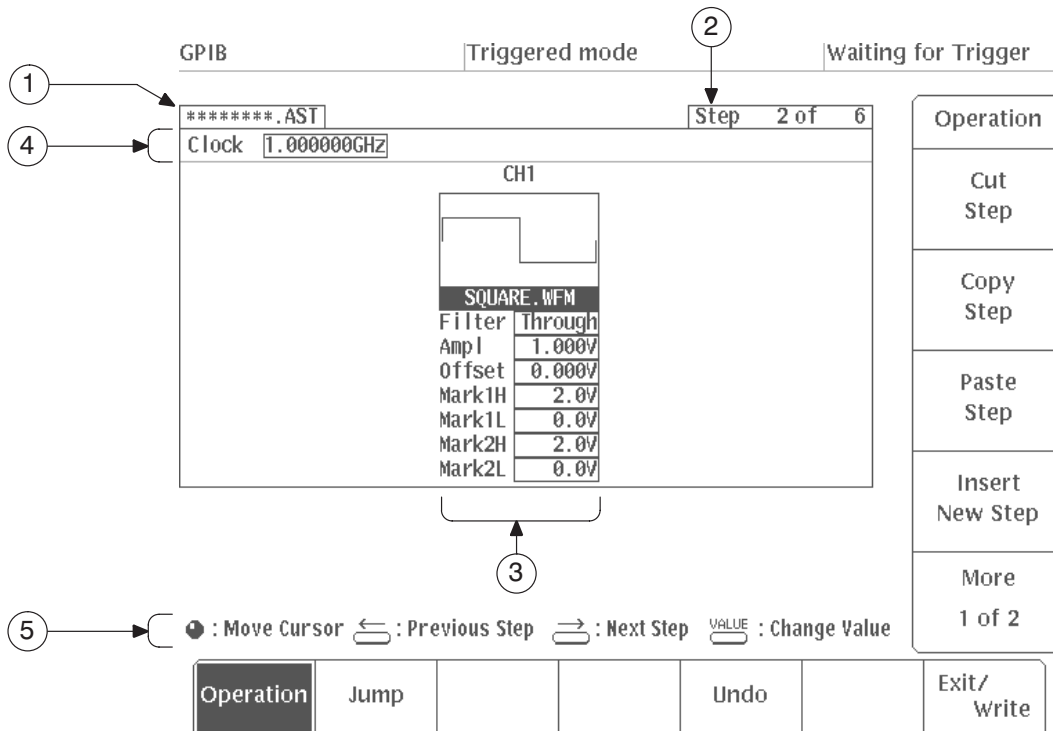

Figure 4A-130: Autostep Editor CRT Display

(1) File Name

The name of the autostep file being edited; if the name has not been set yet, *****.AST is displayed.

(2) Step No.

Indicates the step number in the program. In the example shown in the figure above, the step shown is step 2 out of a total of 6.

(3) CH1 File Setting Area

Indicates the waveform and output parameters for the file in the step indicated by (2). The file and waveform output parameters may be changed.

(4) Clock Frequency

Shows the clock frequency for the file designated in (2). The clock frequency can be changed.

(5) Button Operation

This area shows how the front panel buttons operate in this menu.

 : Move Cursor

Output parameters can be selected by turning the general purpose knob.

 : Previous Step

Pressing this button at a programmed step moves to the previous step.

 : Next Step

Pressing this button at a programmed step moves to the next step.

 : Change Value

Pressing the **VALUE** button makes it possible to set the selected output parameter. Use the general purpose knob to select the output parameter to be set.

Creating and Editing Autostep Programs

Select **Operation** from the bottom menu to create or edit autostep programs. Up to 100 steps can be programmed. If blank steps exist in the autostep program that has been created, these steps will be deleted when you quit the editor.

When using autostep files created on another instrument in the AWG series besides the AWG2041, in some cases there may be no data designated for CH1 of that file. When the files are loaded from disk into the AWG2041, the data for all channels other than CH1 will be ignored and only the steps for which data has been set for CH1 will be read in. The file will not be loaded if there is no CH1 data for any of the steps.

Setting Files

The following procedure is used to set a new file at each step.

Procedure

- Step 1:** Select **Operation** from the bottom menu.

To designate a file for step 1:

- Step 2:** Using the general purpose knob, select the item for which a file will be set on CH1.

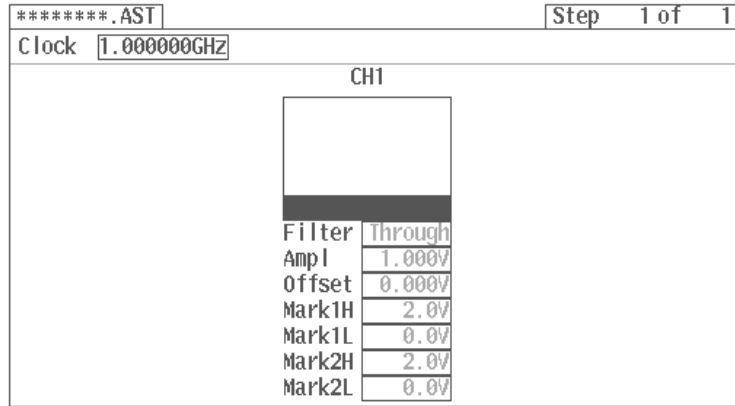

Figure 4A-131: Selecting the Item for File Setting

- Step 3:** Press the **VALUE** button on the front panel. A list of files that can be set will appear.

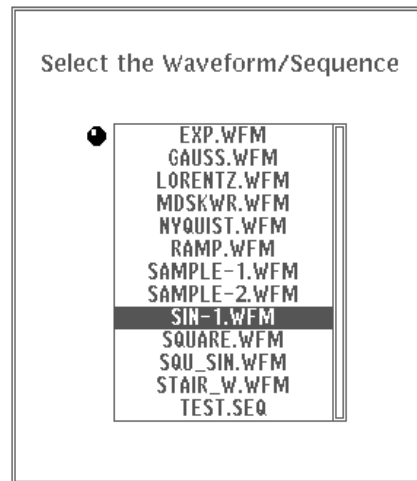

Figure 4A-132: File Selection List

Show Catalog Entry

- Step 4:** Using the general purpose knob, select the desired file.
- Step 5:** If you want to check the waveform of the selected file, select **Show Catalog Entry** from the side menu.

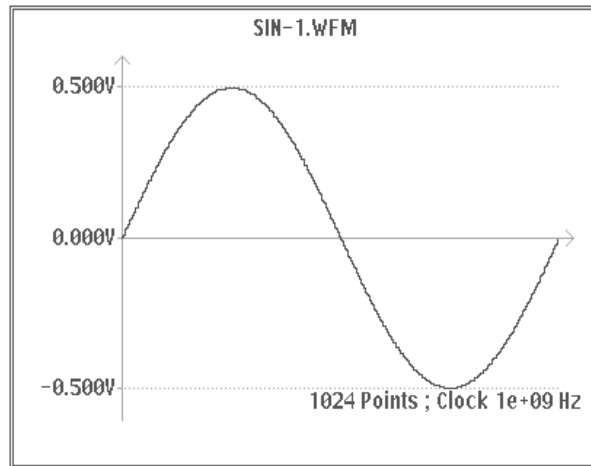

Figure 4A-133: Sample File Waveform Display

The waveform for that file will appear along with the waveform point count, the clock frequency and the voltage value.

- Step 6:** Select **Continue** from the sub-menu.

The menu shown before you selected **Show Catalog Entry** will reappear.

Set

- Step 7:** Select **Set** from the side menu.

The selected file will be inserted and the output parameters for that waveform will be set.

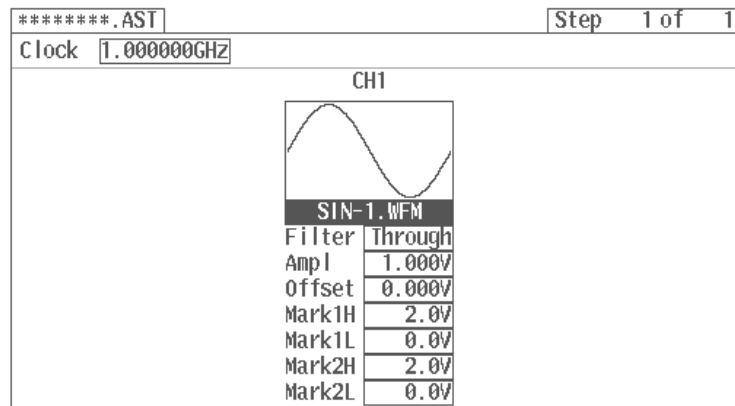

Figure 4A-134: Setting a File

Selecting **Cancel** will cancel the setting operation and the previous menu will appear.

Set
Without
Parameter

Use **Set Without Parameter** instead of **Set** when you want to designate the waveform without changing the parameters. The default parameters will be set when the editor is opened using **New Autostep** or when a waveform is designated for a new step added with **Insert New Step** or **Append New Step**. The default values for the output parameters are shown below.

Clock	1.000 000GHz
Filter	Through
Ampl	1.000V
Offset	0.000V
Mark1H	2.0V
Mark1L	0.0V
Mark2H	2.0V
Mark2L	0.0V

Clear

Use **Clear** to delete the file setting for the current step.

Append
New Step

To add a step:

- Step 8:** Select **More** from the side menu to display **More 2 of 2** and then select **Append New Step**. The instrument will proceed to Step 2. See "Adding a Step" in this manual.

Repeat this procedure to create the program.

Changing Parameters

It is possible to change the output parameters for a file that has been set. These changes are only applied to the autostep file; the original parameters for the files at each step do not change.

Procedure

- Step 1:** Use the ← and → buttons on the front panel or the **Jump** item in the bottom menu to move to the step whose parameters you want to change.
- Step 2:** Select **Operation** from the bottom menu.
- Step 3:** Turn the general purpose knob to select the parameter to be changed.
- Step 4:** Press the **VALUE** button on the front panel. The menu for that parameter will appear.
- Step 5:** Set the parameters as desired. See the descriptions of the individual parameters on the following pages.
- Step 6:** Select **O.K.** from the side menu. The parameters will be updated to the selected items or set values. Selecting **Cancel** will cancel the setting operation and the previous menu will reappear.

Clock Settings

Select "Clock " using the general purpose knob. Then press the **VALUE** button on the front panel. The menu shown in Figure 4A-135 will appear.

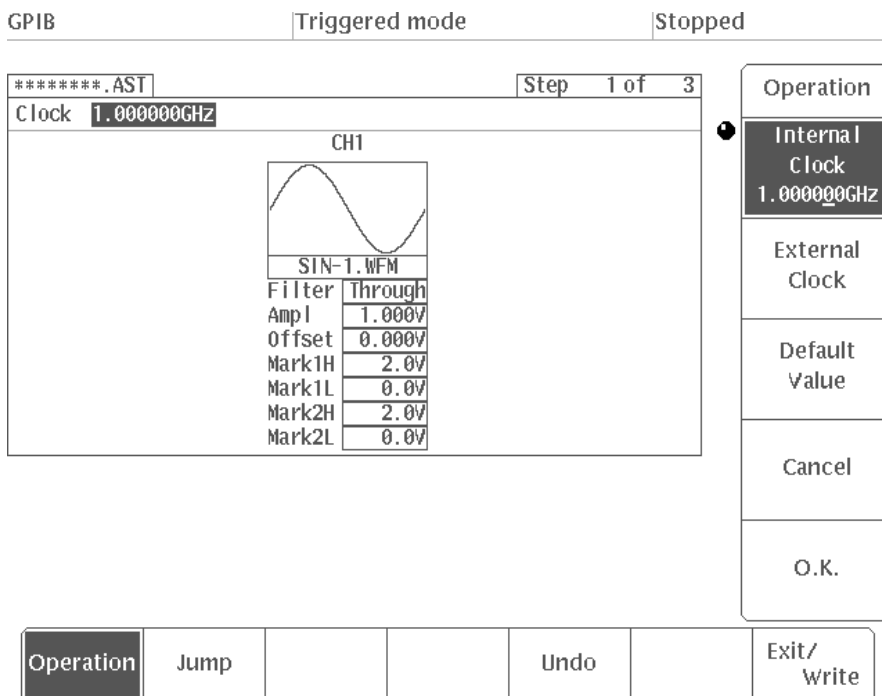

Figure 4A-135: Clock Setting Menu

Set the clock source and the clock frequency by selecting the appropriate items in the side menu.

Internal
Clock

Internal Clock

Selects the internal clock. Use the numeric keys or the general purpose knob to set the internal clock frequency.

External
Clock

External Clock

Selects the external clock. The external clock signal is input through the **CLOCK IN** connector on the rear panel of the instrument.

Default
value

Default Value

Sets the internal clock frequency to the default value of 1.000000 GHz.

After setting the clock source and clock frequency, select **O.K.** from the side menu. The values for clock source and clock frequency will be updated to the values you have set.

Filter Settings

Using the general purpose knob, select "Filter " and then press the **VALUE** button on the front panel. The menu shown in Figure 4A-136 will appear.

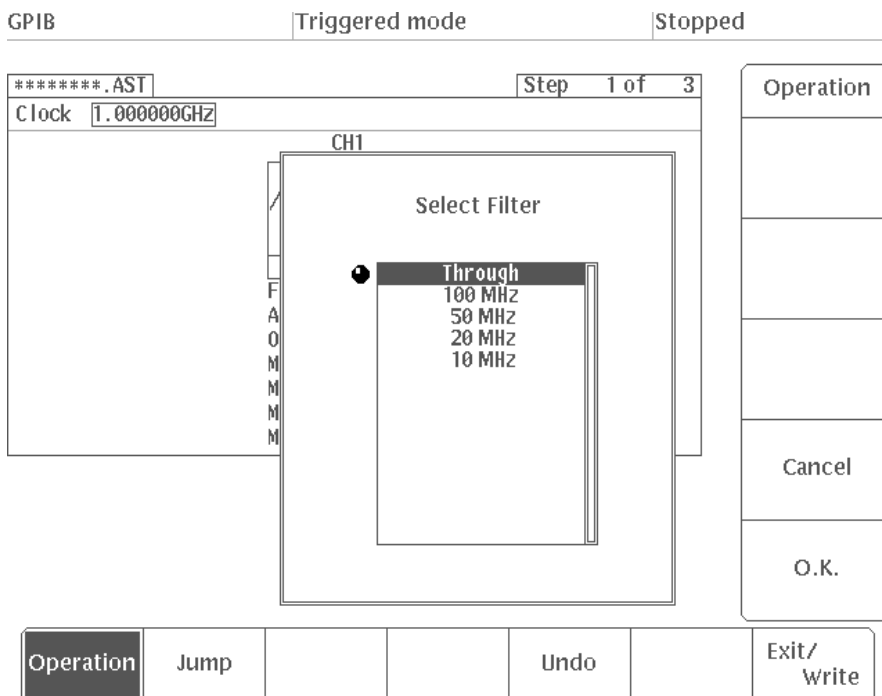

Figure 4A-136: Filter Setting Menu

Using the general purpose knob, select the type of filter. After selecting the filter type, select **O.K.** from the side menu. The filter type will be updated to what you have set.

Amplitude Settings

Using the general purpose knob, select "Ampl " and then press the **VALUE** button on the front panel. The menu shown in Figure 4A-137 will appear.

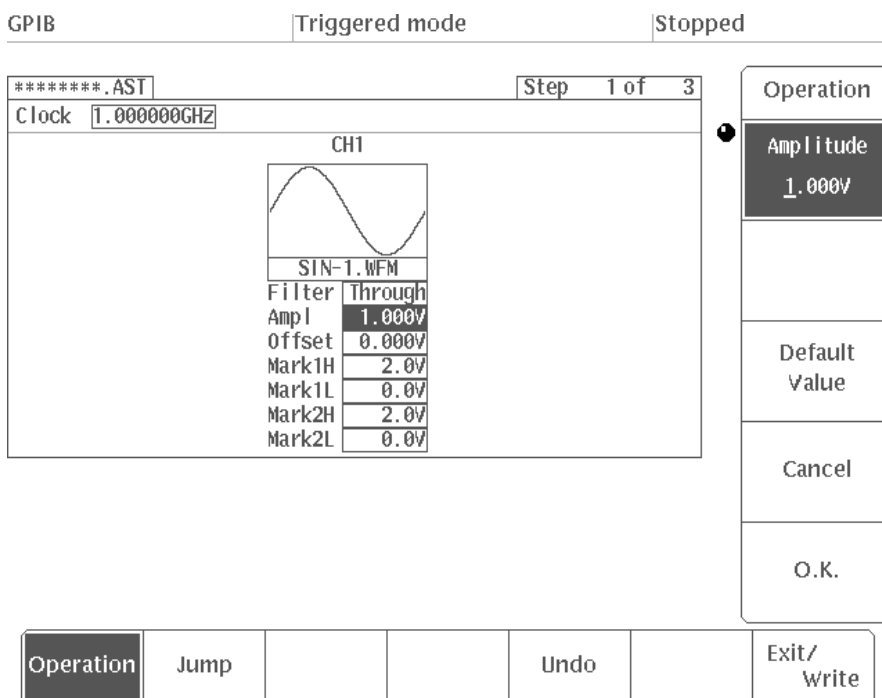

Figure 4A-137: Amplitude Setting Menu

Select the appropriate item in the side menu and set the amplitude.

Amplitude

Amplitude

Select this item and use the numeric keys or the general purpose knob to set the desired amplitude value.

Default value

Default Value

This item sets the amplitude to the default value of 1.000 V.

After setting the amplitude, select **O.K.** from the side menu. The value for amplitude will be updated to the value you have set.

Offset Settings

Using the general purpose knob, select "offset " and then press the **VALUE** button on the front panel. The menu shown in Figure 4A-138 will appear.

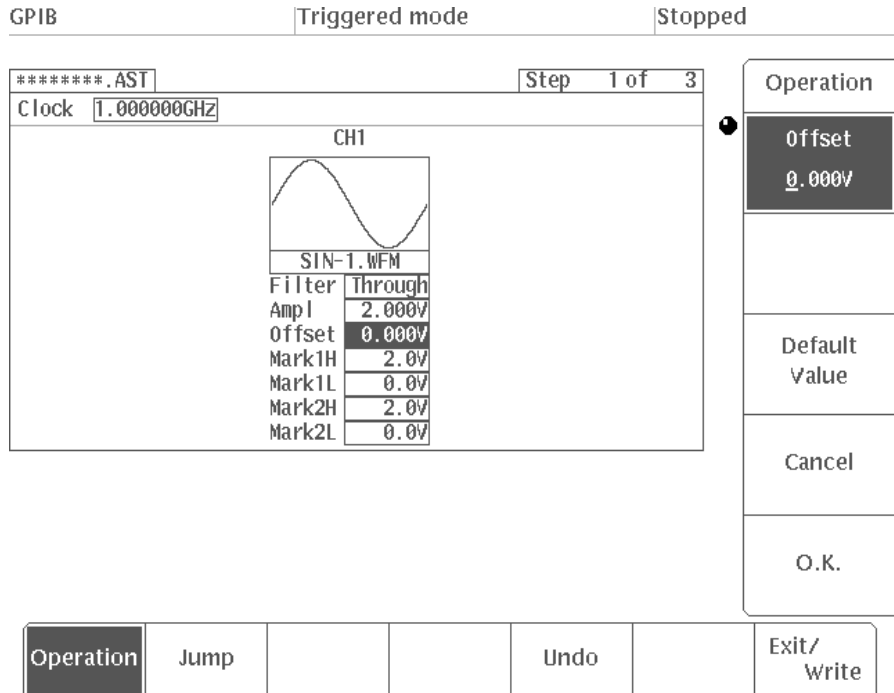

Figure 4A-138: Offset Setting Menu

Select the appropriate item in the side menu and set the offset.

Offset

Offset

Select this item and use the numeric keys or the general purpose knob to set the desired offset value.

Default value

Default Value

This item sets the offset to the default value of 0.000 V .

After setting the offset, select **O.K.** from the side menu. The value for offset will be updated to the value you have set.

Marker Settings

Select "Mark1H []", "Mark1L []", "Mark2H []" or "Mark2L []" with the general purpose knob and then press the **VALUE** button on the front panel. Figure 4A-139 shows an example in which **Mark1H** has been selected.

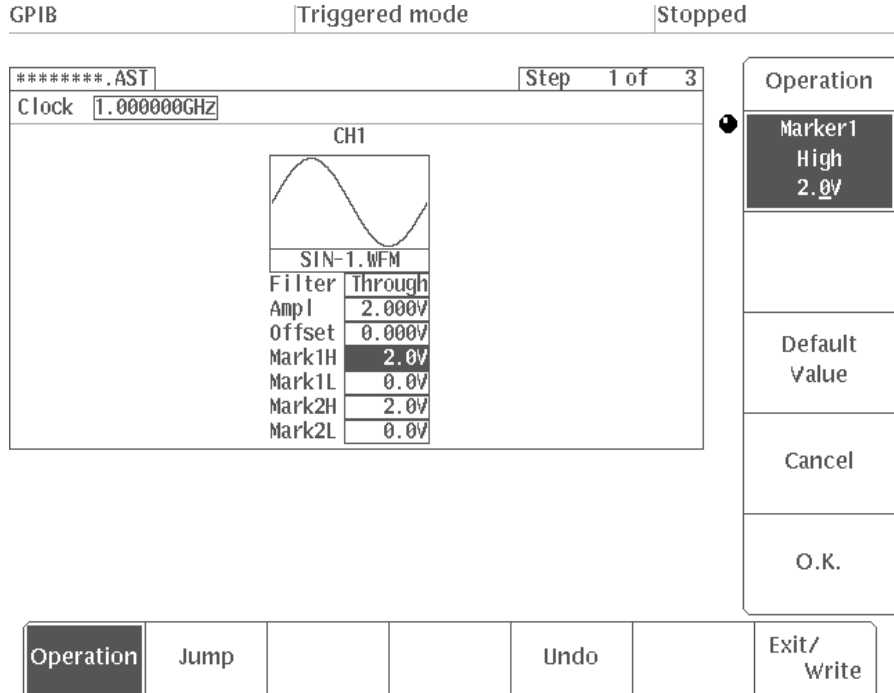
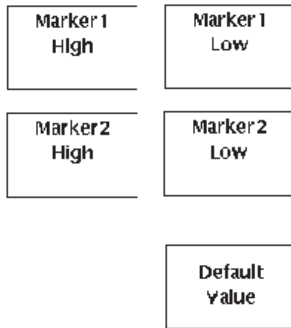

Figure 4A-139: Marker Setting Menu

Select the appropriate item in the side menu and set the marker level.



Marker

Use the numeric keys or the general purpose knob to set the desired marker level. The **High > Low** relationship is preserved during level setting.

Default Value

Use this item to set the marker to the default level. The default high level is 2.0V; the default low level is 0.0V.

After setting the marker level, select **O.K.** from the side menu. The value for marker level will be updated to the value you have set.

Operation

Editing Functions

When you select **Operation** in the bottom menu, the following items appear in the side menu:

- **Cut Step**
- **Copy Step**
- **Paste Step**
- **Insert New Step**
- **Append New Step**
- **Insert Current Setup**

Cut Step

Cutting a Step

Use **Cut Step** if you wish to delete a step in the autostep file that you have programmed.

Procedure

- Step 1:** Select **Operation** from the bottom menu.
- Step 2:** Using the ← and → buttons on the front panel, move to the step to be deleted.
- Step 3:** Select **Cut Step** from the side menu.

When **Cut Step** is selected, the current step is deleted. All of the steps after the one that you have deleted will move up one step. To restore this step to its original state, select **Undo** from the bottom menu or **Paste from Buffer** from the side menu.

Copy Step

Paste Step

Copying and Pasting a Step

Use the **Copy Step** and **Paste Step** items to copy a step in the program and paste it to another step.

Procedure

- Step 1:** Move to the step to be copied, using the same procedure as in "Cutting a Step" above.
- Step 2:** Select **Copy Step** from the side menu.

When **Copy Step** is selected, the current step is placed in the paste buffer. This item has no effect on the CRT display.

- Step 3:** Use the ← and → buttons on the front panel or the **Jump** item in the bottom menu to move to the step to which the step in the paste buffer is to be pasted.

- Step 4:** Select **Paste Step** from the side menu.

All of the steps after the one that has been pasted will move down one step.

Adding a Step

Use **Insert New Step** and **Append New Step** when you wish to add a step to an autostep file being created.

Insert
New Step

Used to insert a step at the current step number.

For example, suppose the current step number is **Step 2 of 3**. Selecting **Insert New Step** at this point will add a blank step at step 2 and the step display will read **Step 2 of 4**.

Append
New Step

Append New Step

Used to add a step after the current step number.

For example, suppose the current step number is **Step 2 of 3**. Selecting **Append New Step** at this point will add a blank step at Step 3 and the step display will read **Step 3 of 4**.

Insert
Current
SETUP

Inserting the SETUP Menu Waveforms and Output Parameters

Use **Insert Current SETUP** to insert the waveforms and output parameters that are currently set in the **SETUP** menu at the current step.

Jump

Jumping to a Step

Use **Jump** in the bottom menu to go quickly to a certain step in the autostep program. Using the items in the side menu, you can jump to the first step, the last step or to any step in between.

Step No.

Step No.

Used to move to a step other than the first or last step.

Use the numeric keys or the general purpose knob to enter the number of the desired step.

To
First Step

To First Step

Used to move to the first step.

To
Last Step

To Last Step

Used to move to the last step.

Split/Join Waveform Editor (Option 09)

The waveform editor on the AWG2041 can edit waveforms of up to 256 K words. The instrument has a 1 M-word waveform memory (4 M-word when Option 01 is installed), so when editing waveforms larger than 256 K words you must use the split/join waveform editor to remove the part to be edited or divide the waveform into editable sections. On instruments with Option 09 installed, this editor can be used.

The split/join waveform editor is used to edit waveform files (those with the extension **.WFM**). The editor is used to perform the following actions:

- Divide a file into several smaller files
- Copy or cut a certain range from the file data and create a new file using the data that has been removed
- Insert data from one file into another file and create a new file

Split / Join
Waveform

Entering the Split/Join Waveform Editor

Use the split/join waveform editor to edit an existing waveform file and create a new file. Use the following procedure to open the editor:

Procedure

- Step 1:** Press the **EDIT** button in the **MENU** column. The initial **EDIT** menu will appear.
- Step 2:** Select **More** in the side menu to display the third page of the side menu.
- Step 3:** Select **Split/Join Waveform** from the side menu.

The split/join waveform editor screen will appear.

Exiting the Editor

Use **Exit** (in the bottom menu of the split/join waveform editor) to quit the editor and go back to the initial EDIT menu.

Saving files: when you select **Execute** in the split/join waveform editor, you will be asked to enter a name for the file. Enter the name and select **O.K.** to save the file.

Exit

Split/Join Waveform Editor Menu Structure

The Split/Join Waveform Editor menu has the structure shown in Figure 4A-140.

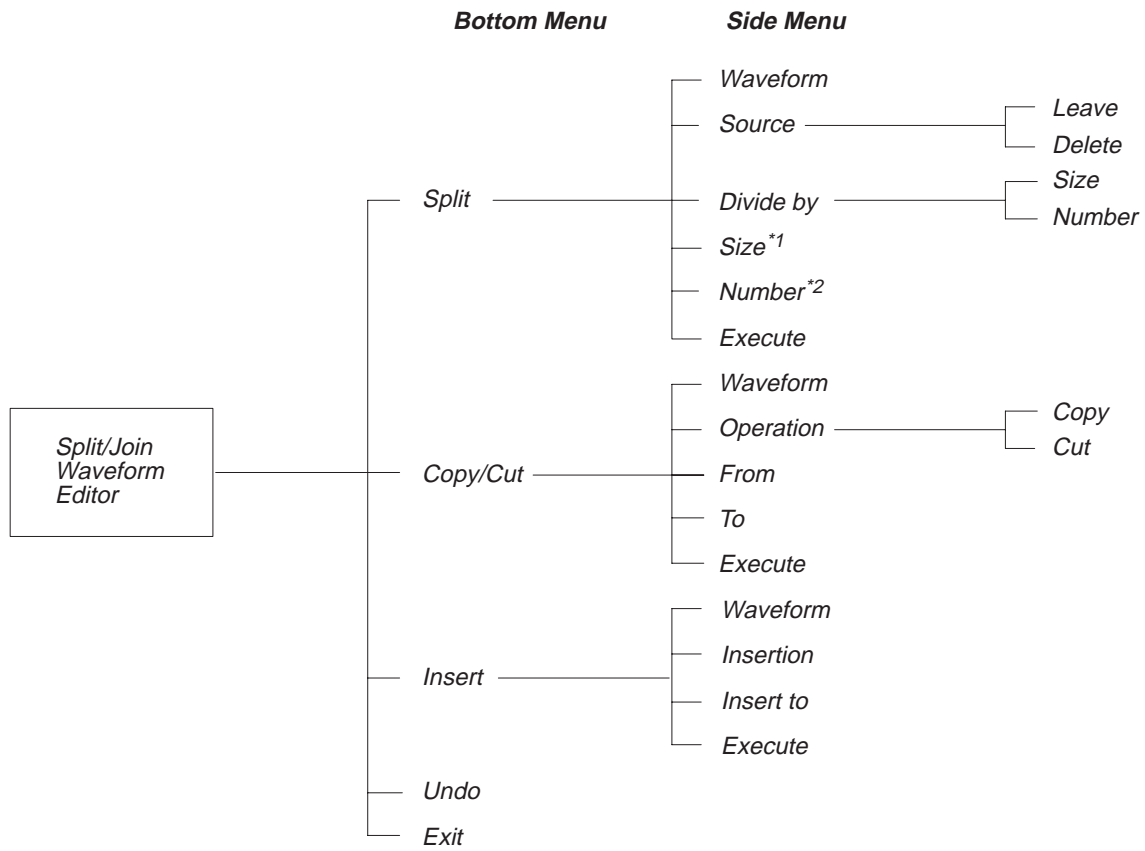

Figure 4A-140: Split/Join Waveform Editor Menu Structure

*1 This item appears when **Size** is selected for **Divide by** in the side menu under **Split**.

*2 This item appears when **Number** is selected for **Divide by** in the side menu under **Split**.

Menu Functions

The following list shows the functions available for each menu item and the page on which you can find a description of that function.

Table 4A-9: Menu Functions

Menu	Function	Page
Split / Join Waveform	Entering the split/join waveform editor	4A-192
Split	Splitting waveform file	4A-197
Copy / Cut	Copying and cutting part of a waveform file	4A-199
Insert	Inserting waveform file	4A-200
Undo	Canceling function execution	4-2
Exit	Exiting the Editor	4A-192

Split/Join Waveform Editor Display

Figure 4A-141 shows the general split/join waveform editor display.

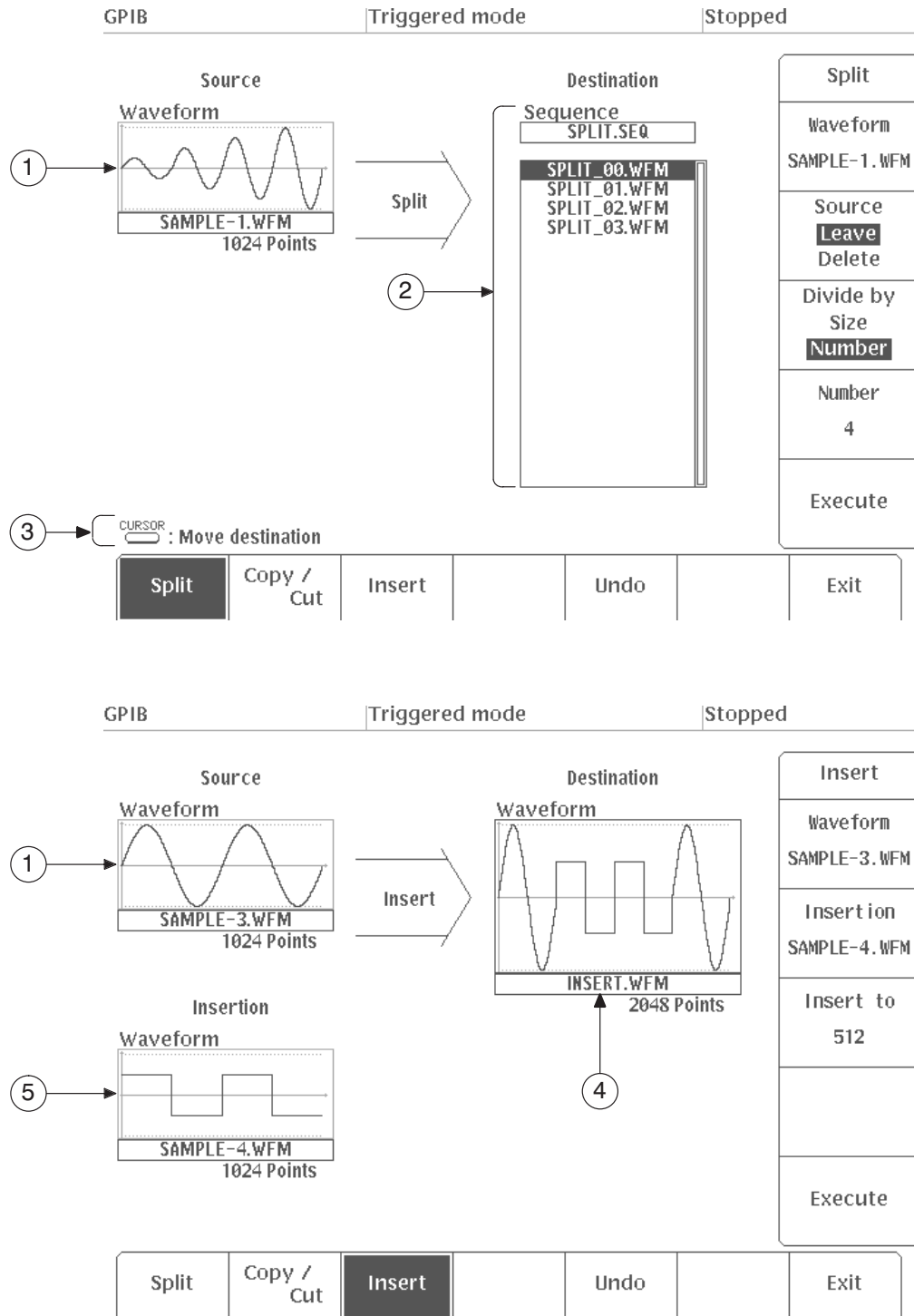

Figure 4A-141: Split/Join Waveform Editor CRT Display

(1) Source Waveform Display Area

When a waveform file is selected from the internal memory, the waveform, the file name and the point count are shown here.

(2) Destination File Name Area

When a **Split** operation is executed and a file name is entered, the sequence and waveform file names are shown here.

(3) Button Operations

This area shows how the front panel buttons operate in this menu.

 : Move destination

When the **CURSOR** button is pressed, the general purpose knob can be used to scroll files in the **Destination** list.

(4) Destination Waveform Area

When a **Copy/Cut** or **Insert** operation is executed and a file name is entered, the waveform, the file name and the point count are shown here.

(5) Insertion Waveform

This area appears when **Insert** in the bottom menu has been selected. When a waveform file for insertion is selected from the internal memory, the waveform, the file name and the point count are shown here.

Split

Splitting Waveform File

Use Split to divide a waveform file into several files. You can split file using either of two methods: **Number** (divisor) or **Size** (waveform point count).

Procedure

- Step 1:** Select **Split** from the bottom menu.
- Step 2:** Select **Waveform** from the side menu.
- Step 3:** Using the general purpose knob, select the waveform file to be divided from the **Select Waveform** list and then select **O.K.** The waveform you have selected will be displayed in the **Source** waveform display area.

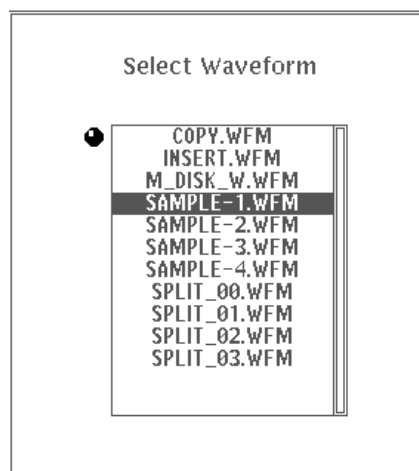

Figure 4A-142: File List

- Step 4:** Press **Source** in the side menu and select either **Leave** or **Delete**.
 Selecting **Delete** will cause the **Source** file to be deleted after the file has been split. Selecting **Leave** causes the **Source** file to be preserved after the file has been split.
- Step 5:** Press **Divide by** in the side menu and select either **Size** or **Number**.
 When **Size** is selected, **Size** will appear in a sub-menu under **Divide by**. This allows you to divide the file by waveform point count.
 When **Number** is selected, **Number** will appear in a sub-menu under **Divide by**. This allows you to divide the file in equal portions by the value designated with **Number**.
- Step 6:** Select either **Size** or **Number** from the side menu.

- Step 7:** Using the numeric keys or the general purpose knob, enter a value for either **Size** (waveform point count) or **Number** (enter divisor) as the unit for splitting file.

Effective Range of Size and Number

	N≤100	N>100
Size	1~N	[N/100]~N
Number	1~N	1~100

N: waveform point count

[]: integer formed by rounding up values past the decimal point.

- Step 8:** Select **Execute** from the side menu. You will be asked to enter a file name for the sequence file that will be created.
- Step 9:** Enter the file name. To confirm the file name, select **O.K.** To cancel the operation, select **Cancel**.

When **O.K.** is selected, a sequence file and the split waveform files will be created and listed in the **Destination** file name area. Waveform file names will be the first five characters of the sequence file name, followed by a number and the waveform extension (**.WFM**) -- for example, *******_00.WFM**, *******_01.WFM**, *******_02.WFM** ... *******_99.WFM** and so on.

When the waveform point count cannot be divided evenly, a fraction will be created. This fraction will form the last split waveform file. In the following examples, a **2048**-point waveform has been split.

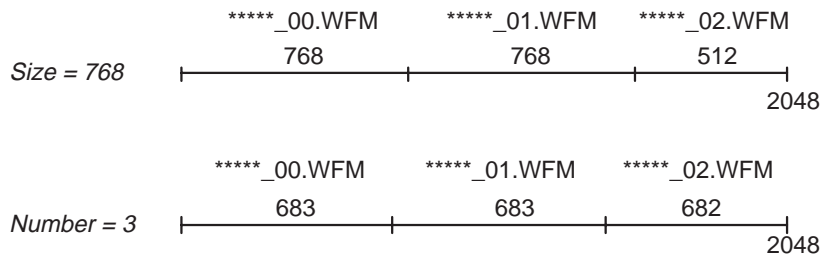

Figure 4A-143: Point Sizes After Splitting Waveform File

If **Cancel** is selected, the file will not be created and the previous **Split** menu will reappear.

- Step 10:** Select **Exit** from the bottom menu. The **Split** menu will disappear and the initial **EDIT** menu will reappear.

The sequence file and split waveform files will be added to the file list in the initial **EDIT** menu.

Copy / Cut

Copying and Cutting Part of a Waveform File

Use **Copy/Cut** to copy or cut a certain range of the file data and use the data that has been removed/copied to create a new file.

Procedure

- Step 1:** Select **Copy/Cut** from the bottom menu.
- Step 2:** Select **Waveform** from the side menu.
- Step 3:** Using the general purpose knob, select the waveform file to be copied or cut from the **Select Waveform** list and then select **O.K.** The waveform you have selected will be displayed in the **Source** waveform display area.
- Step 4:** Press **Operation** in the side menu and select either **Copy** or **Cut**.

Selecting **Copy** does not change the **Source** file.

Selecting **Cut** removes the selected range of data from the **Source** file.
- Step 5:** Select **From** from the side menu.
- Step 6:** Using the numeric keys or the general purpose knob, designate the first point for the range of data to be copied or cut.
- Step 7:** Select **To** from the side menu.
- Step 8:** Using the numeric keys or the general purpose knob, designate the end point for the range of data to be copied or cut.
- Step 9:** Select **Execute** from the side menu. You will be asked to enter a file name for the waveform file that will be created.
- Step 10:** Enter the file name. To confirm the file name, select **O.K.** To cancel the operation, select **Cancel**.

If **O.K.** is selected, a new waveform file will be created with the data copied or cut from the **Source** waveform. This waveform will be displayed in the **Destination** waveform area.

If **Cancel** is selected, the file will not be created and the previous **Copy/Cut** menu will reappear.

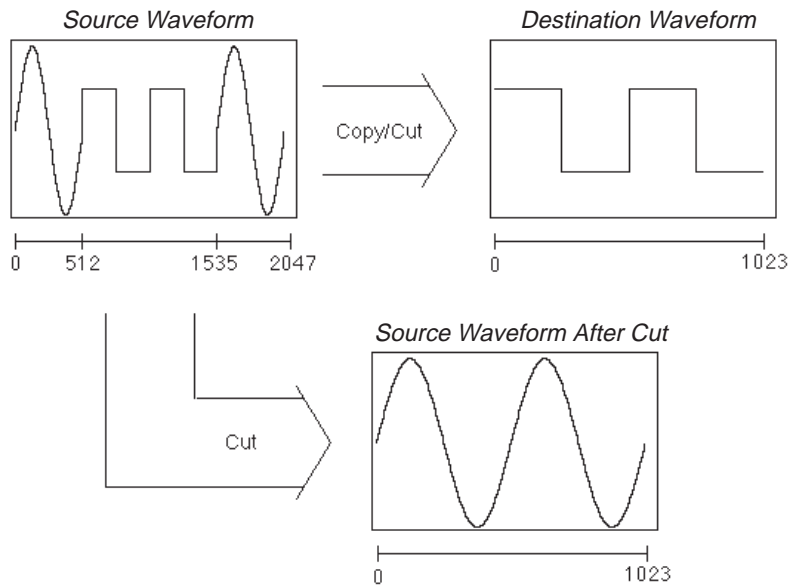

Figure 4A-144: Waveform File Data Before and After Copy/Cut

- Step 11:** Select **Exit** from the bottom menu. The **Copy/Cut** menu will disappear and the initial **EDIT** menu will reappear.

The newly created waveform file will be added to the file list in the initial **EDIT** menu.

Inserting Waveform File

Insert

Use **Insert** to insert the data for a file into another file to create a new file.

Procedure

- Step 1:** Select **Insert** from the bottom menu.
- Step 2:** Select **Waveform** from the side menu.
- Step 3:** Using the general purpose knob, select the waveform file to be inserted from the **Select Waveform** list and then select **O.K.** The waveform you have selected will be displayed in the **Source** waveform display area.
- Step 4:** Select **Insertion** from the side menu.
- Step 5:** Using the general purpose knob, select the waveform file for insertion into the **Source** file from the **Select Waveform** list and then select **O.K.** The waveform you have selected will be displayed in the **Insertion** waveform display area.
- Step 6:** Select **Insert to** from the side menu.

- Step 7:** Using the numeric keys or the general purpose knob, designate a point value for the position in the Source waveform at which you want to insert the data.
- Step 8:** Select **Execute** from the side menu. You will be asked to enter a file name for the waveform file that will be created.
- Step 9:** Enter the file name. To confirm the file name, select **O.K.** To cancel the operation, select **Cancel**.

When you select **O.K.**, a new waveform file will be created in which the **Insertion** waveform has been inserted into the **Source** waveform. This waveform will be displayed in the **Destination** waveform area.

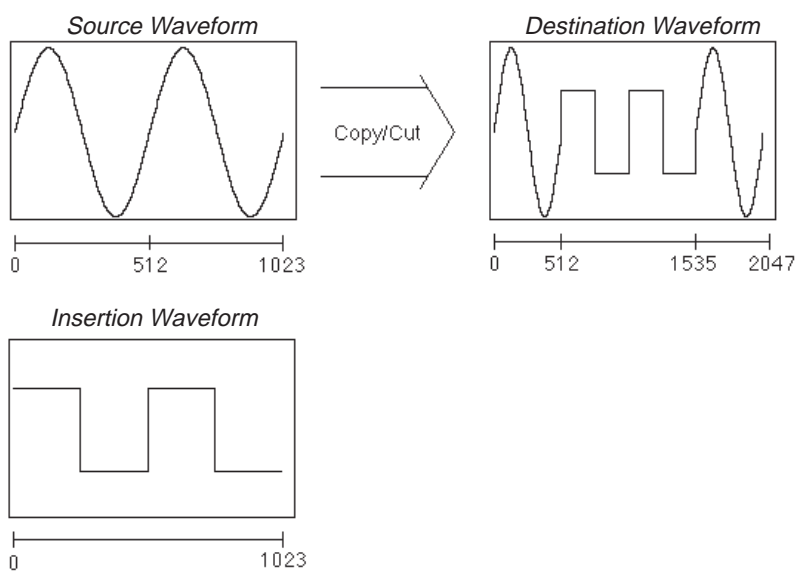

Figure 4A-145: Waveform File Data Before and After Insertion

If **Cancel** is selected, the file will not be created and the previous **Insert** menu will reappear.

- Step 10:** Select **Exit** from the bottom menu. The **Insert** menu will disappear and the initial **EDIT** menu will reappear.

The newly created waveform file will be added to the file list in the initial **EDIT** menu.

Convolution Waveform Editor (Option 09)

On instruments with Option 09 installed, high-speed convolution and correlation can be performed for up to 32 K words of waveform data in existing waveform files (those with the extension **.WFM**).

The number of points in the waveform after calculation will be the sum of the point count of the two selected waveform files. The calculated amplitude will be normalized.

NOTE. *The calculated result of waveform consisting of P number of points and N number of points will be P + N - 1. For the sake of convenience, however, on this instrument a final value of 0.0 is added, so the result is P + N.*

On discrete systems, the convolution $y(n)$ of waveform $x(n)$ and waveform $h(i)$ is expressed by the following formula. Here N is the number of data items. The operation expressed by this formula is called convolution.

$$y(n) = \sum_{i=0}^{N-1} x(i)h(n-i)$$

Alternately, the correlation $y(n)$ of waveform $x(n)$ and waveform $h(i)$ is expressed by the following formula. Here N is the number of data items. The only difference between this equation and the one expressing convolution above is the sign in the parentheses, so with left-right symmetrical waveforms the results will be identical.

$$y(n) = \sum_{i=0}^{N-1} x(i)h(n+i)$$

Convolve
Waveform

Entering the Convolution Waveform Editor

In this editor, you select an existing waveform file and perform either convolution or correlation and then create a new file. Use the following procedure to open the editor:

Procedure

- Step 1:** Press the **EDIT** button in the **MENU** column. The initial **EDIT** menu will appear.
- Step 2:** Select **More** from the side menu to display the third page of the side menu: **3 of 3**.
- Step 3:** Select **Convolve Waveform** from the side menu.

The convolution waveform editor screen will appear.

Exit/
Write

Saving Files and Exiting the Editor

When you select **Exit/Write** from the bottom menu, depending on what you have selected in the side menu, a file name will be assigned to the calculated result and the file will be saved to internal memory, after which the editor will close. When you quit the editor, the initial **EDIT** menu will reappear.

The same procedure is used to save the file and exit from the convolution waveform editor as for the waveform editor. See "Saving Files and Exiting the Editor" in the section on the waveform editor.

Convolution Waveform Editor Menu Structure

The Convolution Waveform Editor menu has the structure shown in Figure 4A-146.

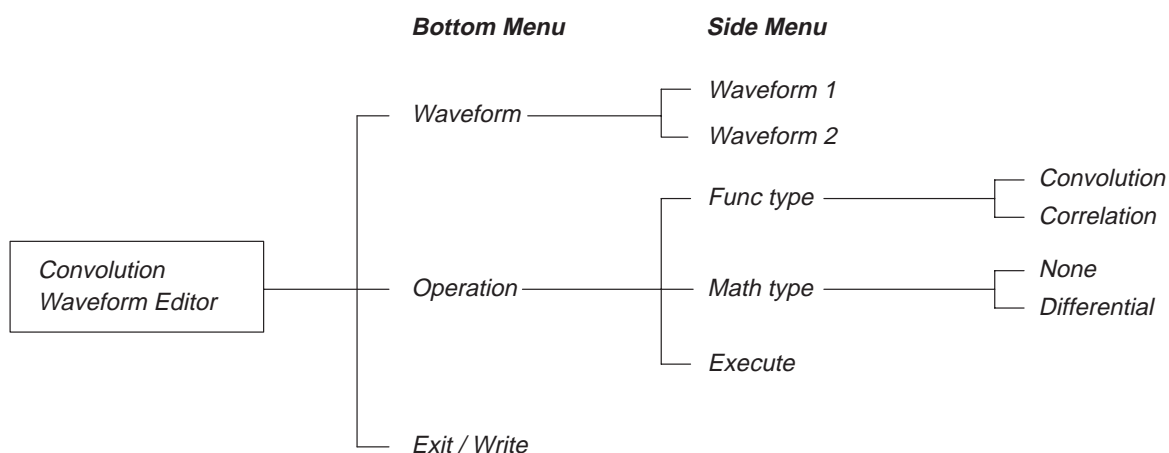

Figure 4A-146: Convolution Waveform Editor Menu Structure

Menu Functions

The following list shows the functions available for each menu item and the page on which you can find a description of that function.

Table 4A-10: Menu Functions

Menu	Function	Page
Waveform	Selecting a waveform file	4A-205
Operation	Executing convolution/correlation	4A-206
Exit/Write	Saving files and exiting the editor	4A-21 , 4A-203

Convolution Waveform Editor Menu Display

Figure 4A-147 shows the general convolution waveform editor display.

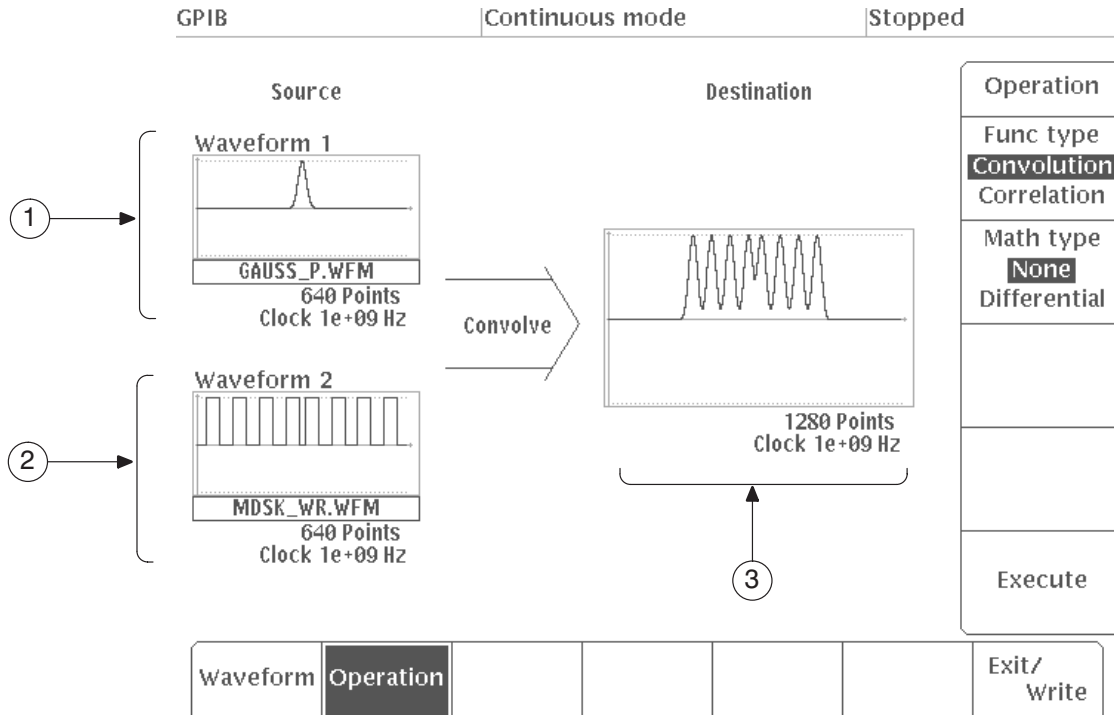

Figure 4A-147: Convolution Waveform Editor CRT Display

(1) Source Waveform1 Display Area

When the waveform file for operation is selected from internal memory, the waveform for that file will be displayed in this area along with the file name, clock frequency and number of points making up the waveform.

(2) Source Waveform2 Display Area

When the other waveform file for operation is selected from internal memory, the waveform for that file will be displayed in this area along with the file name, clock frequency and number of points making up the waveform.

(3) Destination Waveform Display Area

The result of operations for **Waveform1** and **Waveform2** will be displayed in this area as a waveform. The waveform point count will be the sum of the point count for **Waveform1** and **Waveform2**. When the data is saved, the clock frequency for **Waveform1** will be saved to that file.

Waveform

Selecting a Waveform File

In this example, you will select a waveform file for operation.

Procedure

- Step 1:** Select **Waveform** from the bottom menu.
- Step 2:** Select **Waveform1** from the side menu.
- Step 3:** Using the general purpose knob, select the waveform file for operation from the **Select Waveform** list and then select **O.K.** The waveform you have selected will be displayed in the **Waveform1** display area under **Source**.
- Step 4:** Select **Waveform2** from the side menu.
- Step 5:** Using the general purpose knob, select the other waveform file for operation from the **Select Waveform** list and then select **O.K.** The waveform you have selected will be displayed in the **Waveform2** display area under **Source**.

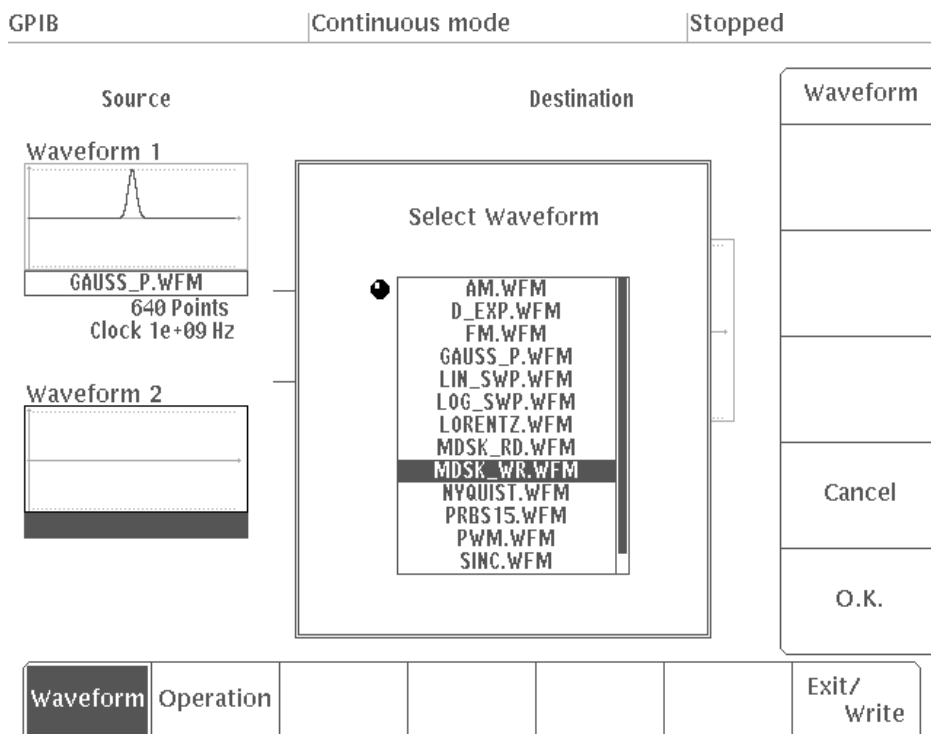

Figure 4A-148: Selecting a Waveform File

Operation

Executing Convolution/Correlation

When you select **Operation** in the bottom menu, convolution or correlation will be performed. If **Differential** has been selected for the **Math type** item, the calculated result will be differentiated.

Procedure

- Step 1:** Select **Operation** from the bottom menu.
- Step 2:** Press **Func type** in the side menu and select either **Convolution** or **Correlation**.
- Step 3:** If you would like to differentiate the calculated result, select **Differential** for the **Math type** item. Differentiation will be used when need for reading waveforms from magnetic disks.
- Step 4:** Select **Execute** from the side menu to execute the operation.

Func type
Convolution
Correlation

Math type
None
Differential

The point count of the waveform data after operation will be the sum of the point count of the two waveform files you have selected.

Figure 4A-149 shows an example of convolution for which differentiation has been performed. Figure 4A-150 shows an example of correlation.

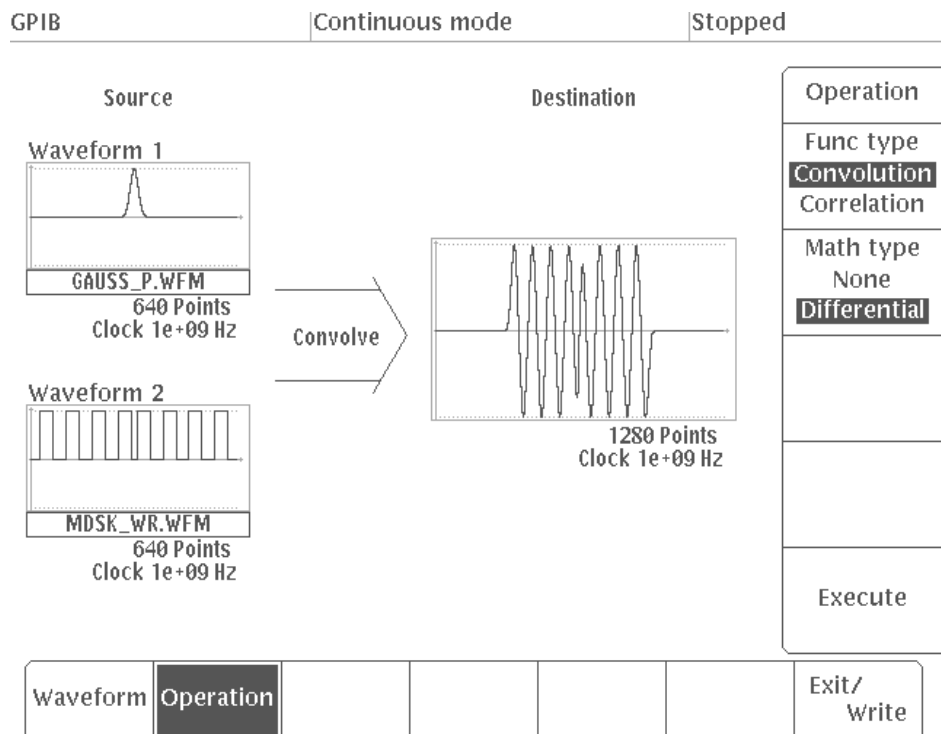

Figure 4A-149: Sample Convolution

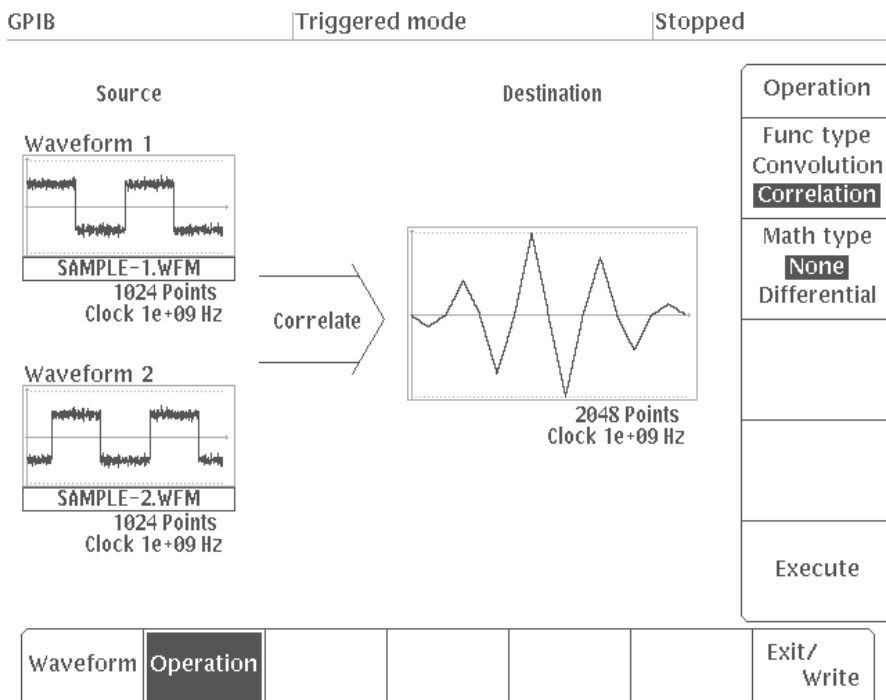

Figure 4A-150: Sample Correlation

FFT Editor (Option 09)

On instruments with Option 09 installed, existing waveform files with the extension **.WFM** can be edited in the frequency domain. When the editor is started, Fast Fourier Transformation (FFT) is automatically carried out and the data is transformed into the frequency domain. When you leave the editor, inverse FFT is carried out to convert the frequency domain data into time domain data.

The window function for fast Fourier transform is selected when the editor is started. Within the editor, filtering (high pass, low pass, band pass, band cut) and clipping are possible.

Entering the FFT Editor

This editor is not used to make new files. Rather, it edits existing waveform files in the frequency domain. Here is the procedure for editing the FFT editor.

Procedure

- Step 1:** Press the **EDIT** button in the **MENU** column. The initial **EDIT** menu will appear.
- Step 2:** Select **More** from the side menu to display the third page of the side menu: **3 of 3**.
- Step 3:** Using the general purpose knob, select the waveform file (**.WFM**) from the file list. The **Edit in Frequency Domain** item is added to the side menu.
- Step 4:** Select **Edit in Frequency Domain** from the side menu. The menu for selecting the window function is displayed. See Figure 4A-151.

Edit in
Frequency
Domain

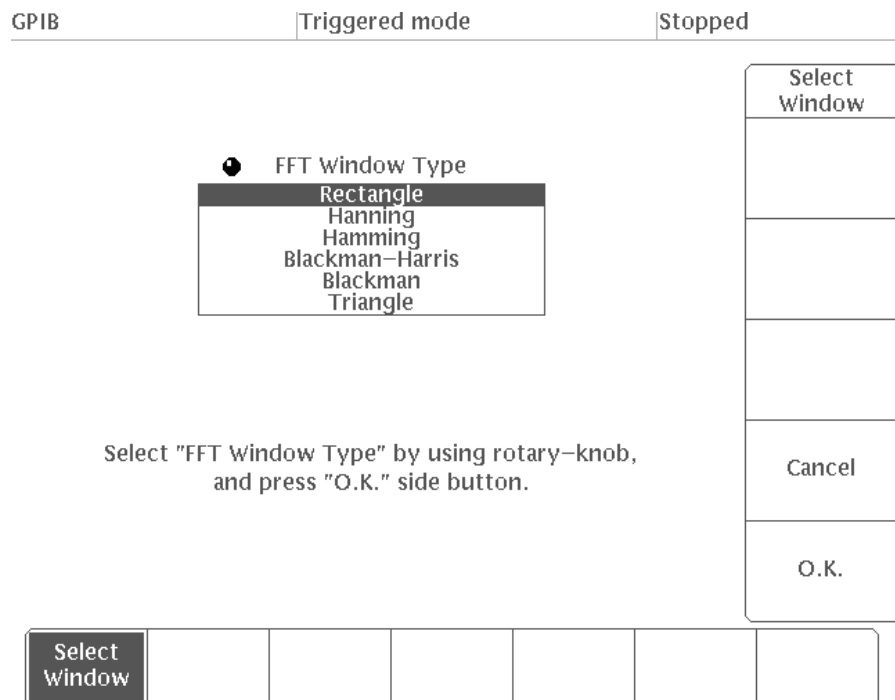

Figure 4A-151: FFT Window Selection Menu

- Step 5:** Using the general purpose knob, select the window function.

When you enter the FFT editor, you must select the window function. This instrument has the following six FFT windows.

- **Rectangle**
- **Hanning**
- **Hamming**
- **Blackman-Harris**
- **Blackman**
- **Triangle**

For repetitive waveforms in which the waveform data starting point and ending point match, the rectangle window is usually used. For details on the window functions, see the FFT (Fast Fourier Transforms) description in Appendix D.

- Step 6:** Next, select **O.K.** from the side menu to enter the FFT editor. The time domain data is transformed into the frequency domain.

To cancel the FFT operation, select **Cancel**. This returns the system to the initial **EDIT** menu.

Exit/
Write

Saving Files and Exiting the Editor

Select **Exit/Write** from the bottom menu. Then select from the side menu to save the edited file to the internal memory of the AWG2041 and exit from the editor. When this is done, the frequency domain data is converted into time domain data and saved as a waveform file.

The same procedure is used to save the file and exit from the FFT editor as for the waveform editor. See "Saving Files and Exiting the Editor" in the section on the waveform editor.

FFT Editor Menu Structure

The FFT Editor menu has the structure shown in Figure 4A-152.

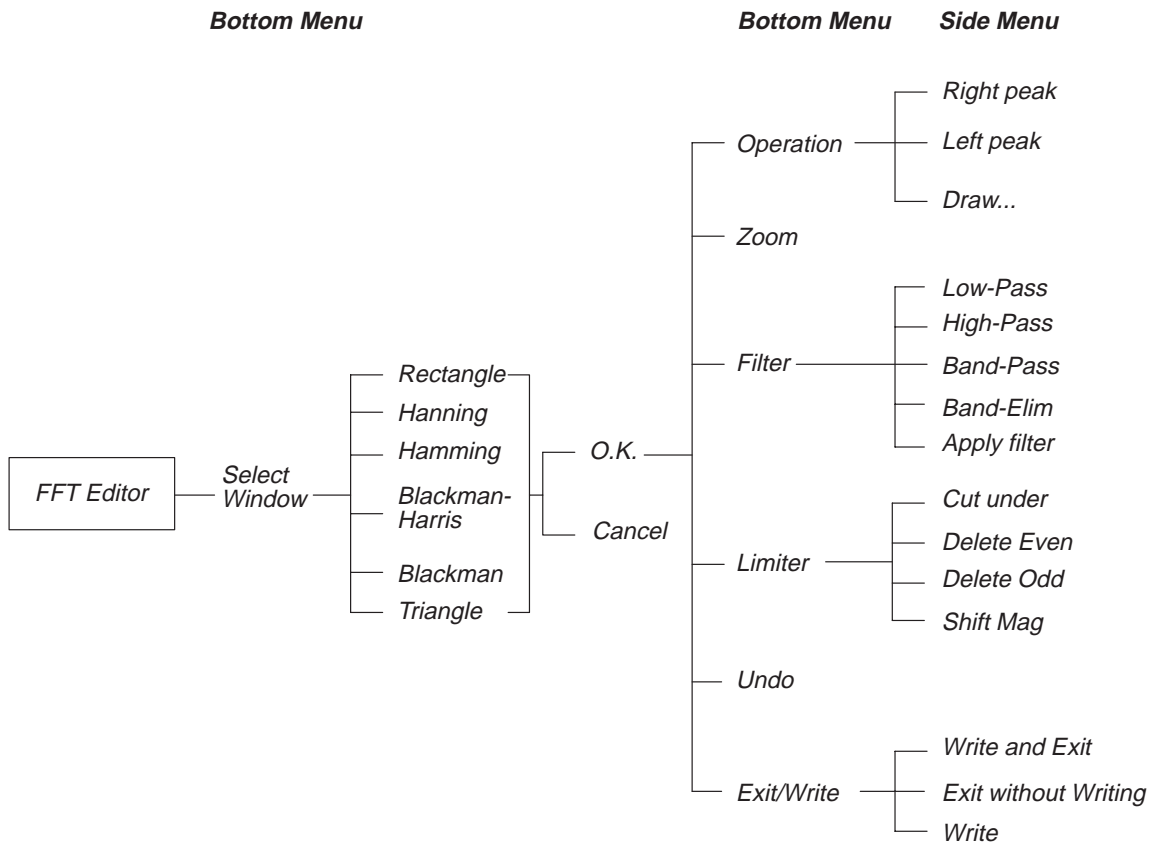

Figure 4A-152: FFT Editor Menu Structure

Menu Functions

The following list shows the functions available for each menu item and the page on which you can find a description of that function.

Table 4A-11: Menu Functions

Menu	Function	Page
Select Window	Selecting a window (Entering the FFT Editor)	4A-208
Operation	Editing in the frequency domain	4A-214
Right peak, Left peak	Searching for peaks	4A-215
Draw...	Drawing magnitude and phase	4A-215
Zoom	Zooming a signal	4A-218
Filter	Selecting a filter	4A-219
Limiter	Selecting a limiter	4A-221
Cut under	Cutting extraneous frequency components	4A-221
Delete Even, Delete Odd	Deleting even or odd components	4A-221
Shift Mag	Sifting magnitudes	4A-222
Undo	Canceling function execution	4-2
Exit/Write	Saving files and exiting the editor	4A-21 , 4A-210

FFT Editor Menu Display

Figure 4A-153 shows the general FFT editor display. A description for each callout follows.

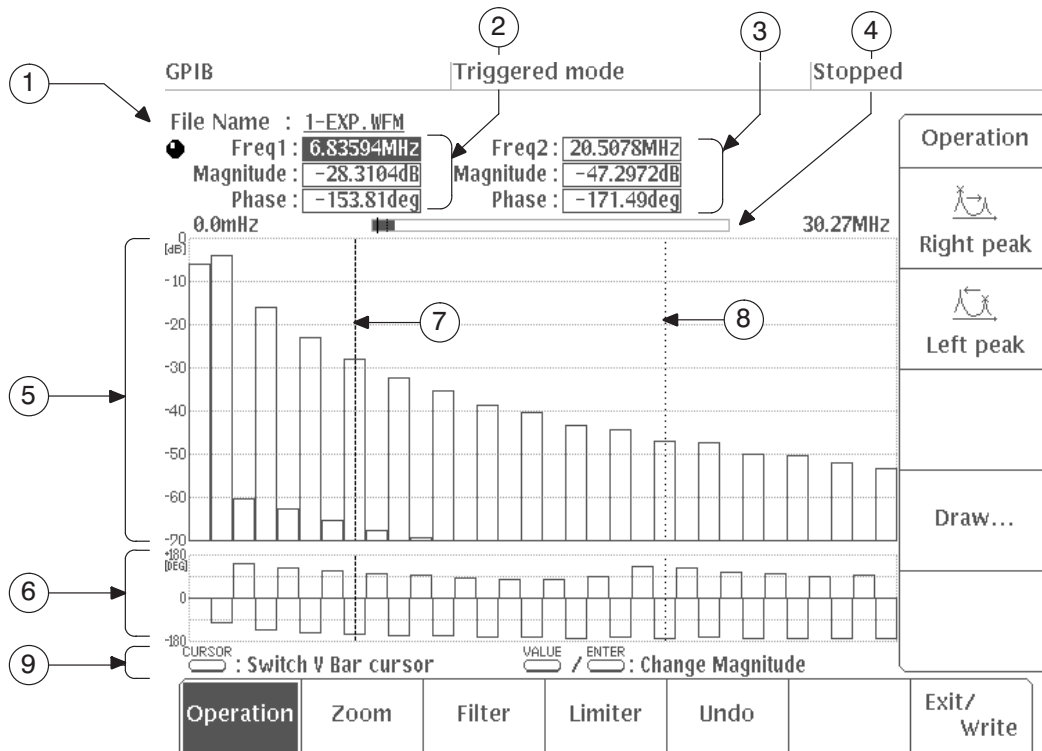

Figure 4A-153: FFT Editor CRT Display

(1) File Name

This is the name of the waveform file being edited.

(2) Freq1: Magnitude: Phase:

This section shows the frequency, magnitude and phase for the position of the left vertical bar cursor. Use the **CURSOR** button to toggle between the left and right vertical bar cursors. Use the **VALUE** button to toggle between magnitude and phase. A knob icon indicates that an item is active. Magnitude values are expressed in dB and phase values are expressed in deg.

**(3) Freq2:
Magnitude:
Phase:**

This section shows the frequency, magnitude and phase for the position of the right vertical bar cursor.

(4) Scroll Indicator

This item shows the position of the display area within the overall waveform. The area displayed on the screen is displayed inverted.

(5) Magnitude Display Area

This area displays the magnitudes for the frequency components.

(6) Phase Display Area

This area displays the phases for the frequency components.

(7) Left Vertical Bar Cursor

The left cursor indicates the left starting point for editing. When active, the cursor will be brightly highlighted.

(8) Right Vertical Bar Cursor

The right cursor indicates the right end point for editing.

(9) Button Operations



This area shows how the front panel buttons operate in this menu.

 : Switch V Bar cursor

Pressing the **CURSOR** button toggles the active vertical bar cursor between left and right.

 /  : Change Magnitude

Pressing the **VALUE** or **ENTER** button puts the system into a mode in which the magnitude at the frequency of the active vertical bar cursor can be changed.

 /  : Change Phase

Pressing the **VALUE** or **ENTER** button puts the system into a mode in which the phase at the frequency of the active vertical bar cursor can be changed.

 : Move V Bar cursor

When **Draw...** has been selected, pressing the **CURSOR** button allows you to move the active vertical bar cursor.

 /  : Move point cursor

When **Draw...** has been selected, pressing the **VALUE** or **ENTER** button allows you to move the point cursor.

 /  : Switch point cursor dir

When **Draw...** has been selected, pressing **VALUE** or **ENTER** button toggles the direction in which the point cursor moves from vertical to horizontal or vice-versa.

Operation

Editing in the Frequency Domain

Select **Operation** from the bottom menu to change the signal magnitude and phase in the frequency domain. The following items will appear in the side menu:

- **Right peak**
- **Left peak**
- **Draw...**

Editing Magnitude

Here is the procedure for editing the magnitudes.

Procedure

- Step 1:** Select **Operation** from the bottom menu.
- Step 2:** Press the **CURSOR** button on the front panel to select the left/right vertical bar cursor. Using the numeric keys or the general purpose knob, move the active vertical bar cursor to the frequency to be edited.
- Step 3:** Press the **VALUE** button on the front panel and select **Magnitude**. The knob icon is displayed on the **Magnitude** side.
- Step 4:** Using the general purpose knob or the numeric keys, change the magnitude.
- Step 5:** To change the magnitude for another frequency, press the **CURSOR** button on the front panel, and use the general purpose knob to move the active vertical bar cursor to the frequency to be edited. Next, repeat Steps 3 and 4.

Editing Phase

Here is the procedure for editing the phase.

Procedure

- Step 1:** Select **Operation** from the bottom menu.
- Step 2:** Press the **CURSOR** button on the front panel to select the left/right vertical bar cursor. Using the numeric keys or the general purpose knob, move the active vertical bar cursor to the frequency to be edited.
- Step 3:** Press the **VALUE** button on the front panel and select **Phase**. The knob icon is displayed on the **Phase** side.
- Step 4:** Using the general purpose knob or the numeric keys, change the phase.
- Step 5:** To change the phase for another frequency, press the **CURSOR** button on the front panel, and use the general purpose knob to move the active vertical bar cursor to the frequency to be edited. Next, repeat Steps 3 and 4.

Searching for Peaks

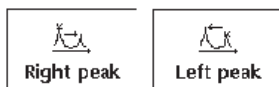

Select **Operation** from the bottom menu to display the **Right peak** and **Left peak** items on the side menu. These items detect the signal peaks.

Right peak — Each time this item is selected, the signal peak to the right of the active vertical bar cursor will be detected and the cursor will move to that point.

Left peak — Each time this item is selected, the signal peak to the left of the active vertical bar cursor will be detected and the cursor will move to that point.

Drawing Magnitude and Phase

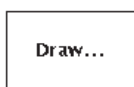

Use **Draw...** to draw points between the left and right vertical bar cursors and then connect the points to create an arbitrary magnitude and phase. Immediately after you select the **Draw...** item, a point cursor will appear midway between the vertical bar cursors, in the center of the vertical axis. The following diagram shows the menu configuration for the **Draw...** item.

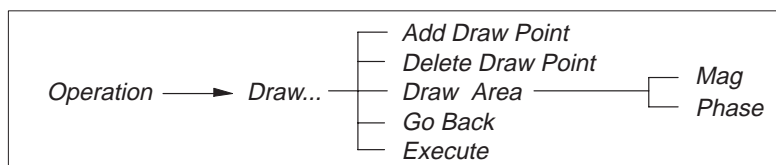

Figure 4A-154 shows an example of the screen with the **Draw...** item selected.

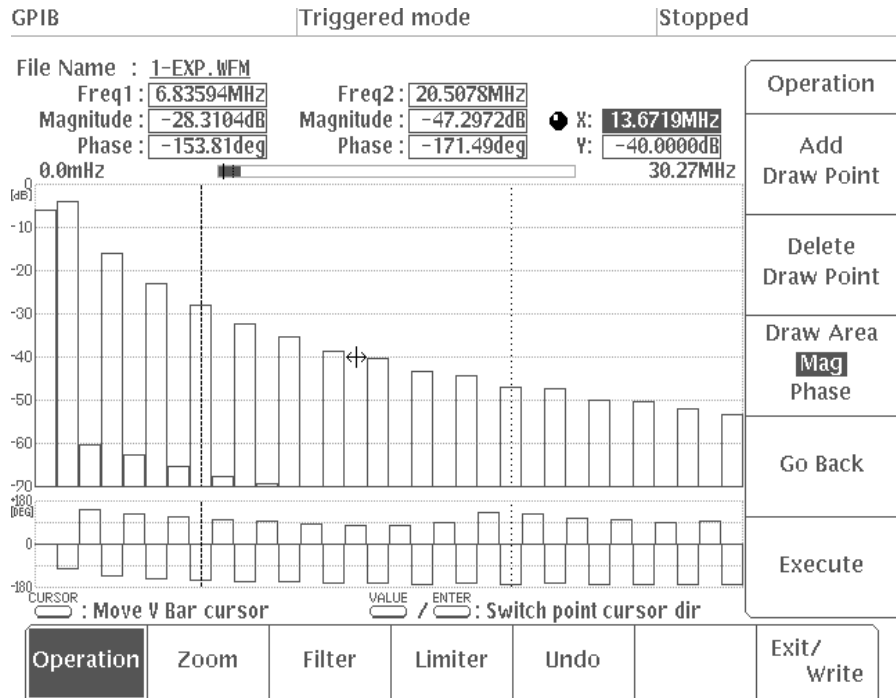

Figure 4A-154: Menu Displayed When Draw... is Selected

When you select **Draw...** from the side menu, the following items will appear in the sub-menu: **Add Draw Point**, **Delete Draw Point**, **Draw Area**, **Go Back** and **Execute**. Each of these items will be explained below in detail.

Procedure

- Step 1:** Select **Operation** from the bottom menu, and then select **Draw...** from the side menu.
- Step 2:** Press the **CURSOR** button on the front panel. Using the general purpose knob, move the left and right vertical bar cursors to define the frequency domain for drawing the magnitude or phase. Use the **CURSOR** button to toggle between the left and right vertical bar cursors.
- Step 3:** Press **Draw Area** in the sub-menu and select **Mag** (magnitude) or **Phase** (phase).
- Step 4:** Press the **VALUE** button on the front panel. Using the general purpose knob, move the point cursor to the location of the new point. Pressing the **VALUE** button will toggle the direction of movement from horizontal (**X**) to vertical (**Y**) and vice-versa. The location of the point cursor is displayed in the upper right-hand corner of the screen in **X** (frequency) and **Y** (magnitude or phase) coordinates.
- Step 5:** When you have placed the point cursor at the desired location, select **Add Draw Point** from the sub-menu to add a point at that location.

It is possible to add points outside the area defined by the vertical bar cursors. However, such points will be ignored when **Execute** is pressed.

NOTE. It is not possible to draw more than one point at the same location on the horizontal axis. If you attempt to do this, a message will appear asking you to confirm that you want to change the level of the existing point. Press **O.K.** or **Cancel** in response to this message.

Step 6: Repeat Steps 4 and 5 to add several new points.

Step 7: To delete a point that you have added with **Add Draw Point**, move the point cursor to that point and select **Delete Draw Point**. The point will be deleted.

If you press **Delete Draw Point** several times in succession, the points that you have added will be deleted in sequence starting with that nearest to the point cursor.

Step 8: Select **Execute** from the sub-menu. The points that you have added will be connected to the magnitude or phase on the area defined by the left and right vertical bar cursors.

Figure 4A-155 shows an example of a magnitude drawn between the vertical bar cursors.

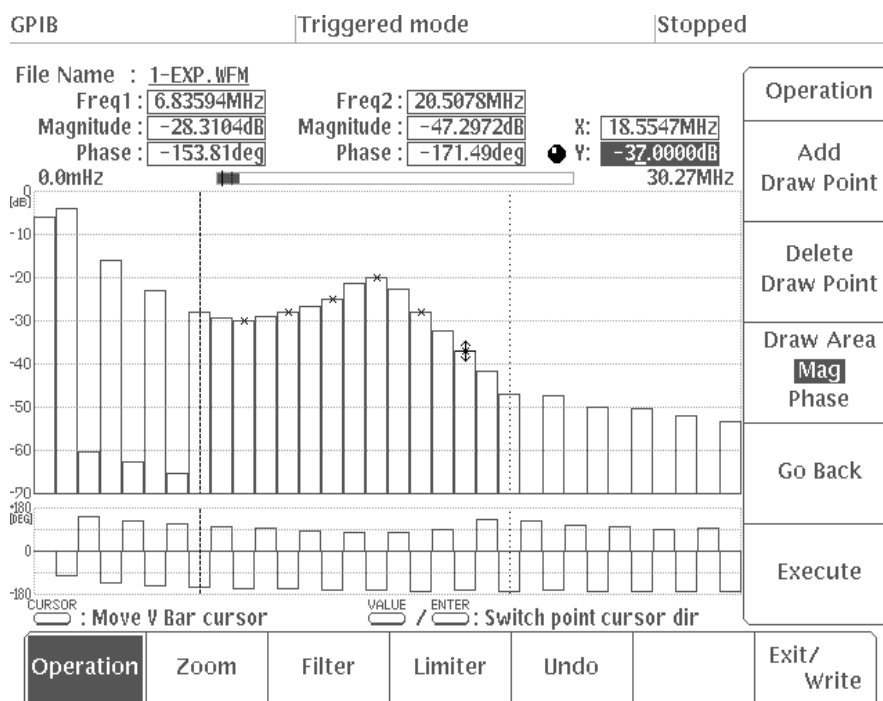

Figure 4A-155: Drawing a Magnitude

- Step 9:** To cancel the execution of a draw operation, select **Undo** from the bottom menu. The screen will revert to the waveform before Execute was selected.

NOTE. When you quit and once again enter the waveform editor, the points you have drawn will disappear.

- Step 10:** Select **Go Back** from the sub-menu. The system returns from the **Draw...** sub-menu to the previous side menu.

This concludes the draw process.

Zooming a Signal

Select **Zoom** from the bottom menu to display menu items that magnify the display of the signal to **x1**, **x4**, **x8**, **x16**, or **x64** along the frequency axis. Figure 4A-156 shows the magnified signal display when Zoom is selected from the bottom menu with **x16** is selected.

Zoom

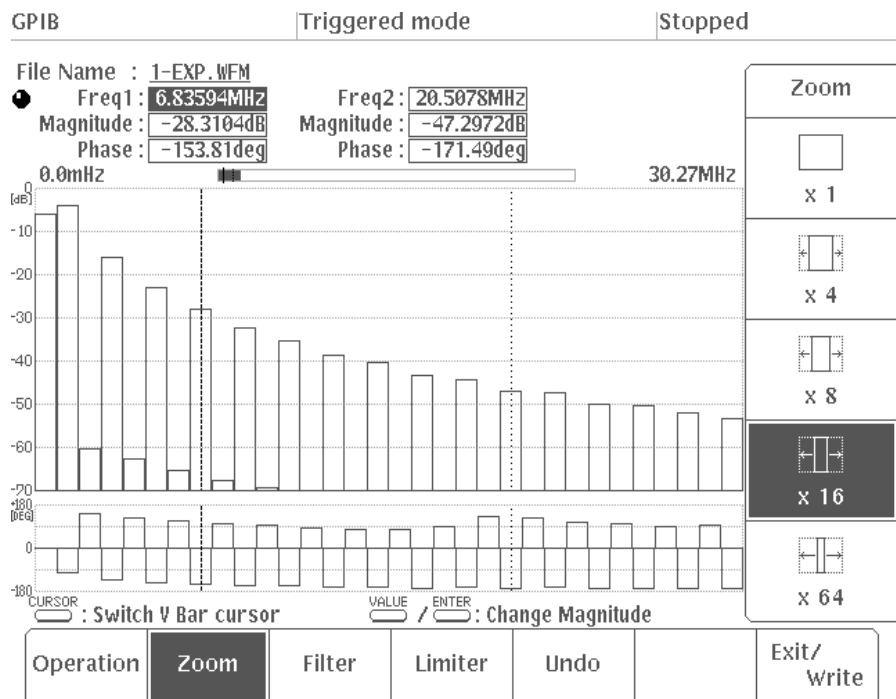

Figure 4A-156: Magnified Signal Display

In the scroll indicator at the top of the screen, the section of the signal being displayed on the screen is displayed inverted. You can scroll through the frequency domain outside the screen by turning the general purpose knob.

Filter

Selecting a Filter

When **Filter** is selected from the bottom menu, the following four frequency filters can be selected from the side menu.

- Low Frequency Pass Filter (**Low-Pass**)
This filter eliminates frequencies greater than the specified frequency.
- High Frequency Pass Filter (**High-Pass**)
This filter eliminates frequencies lower than the specified frequency.
- Band Pass Filter (**Band-Pass**)
This filter eliminates frequencies outside the specified band.
- Band Cut Filter (**Band-Elim**)
This filter eliminates frequencies in the specified band.

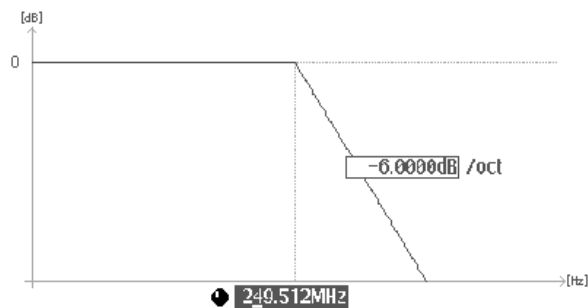

Figure 4A-157: Low Pass Filter

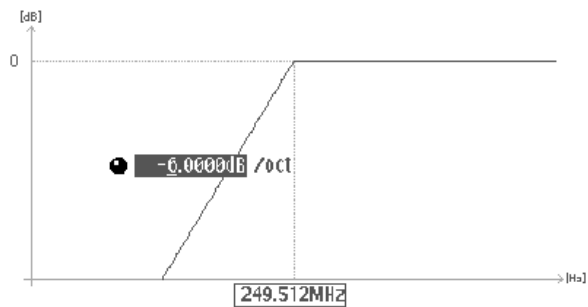

Figure 4A-158: High Pass Filter

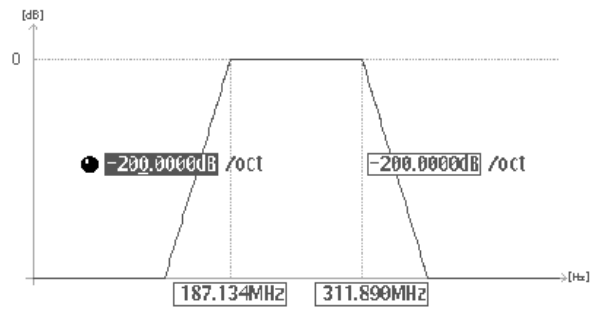

Figure 4A-159: Band Pass Filter

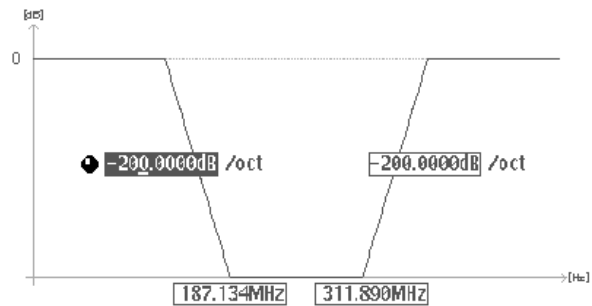

Figure 4A-160: Band Cut Filter

The procedure below applies the filters to the signal.

Procedure

- Step 1:** Select **Filter** from the bottom menu.
- Step 2:** Select **Low-Pass, High-Pass, Band-Pass, or Band-Elim** from the side menu.
- Step 3:** Press the **VALUE** button on the front panel and select the filter frequency field.
- Step 4:** Using the general purpose knob or the numeric keys, set the filter frequency.
- Step 5:** Press the **VALUE** button on the front panel to select the filter slope field.
- Step 6:** Using the general purpose knob or the numeric keys, set the filter slope. Here octave (**oct**) indicates double the frequency.

For a band filter, set the frequency and slope for both ends of the band.

- Step 7:** After setting the filter frequency and slope, select **Apply filter** from the side menu. The specified filter is applied to the signal.

 Limiter

Selecting a Limiter

Use **Limiter** to cut the frequency component below the limit level, to cut the even or odd components on the discrete frequency axis, or to shift the magnitude to the limit level. When **Limiter** is selected from the bottom menu, the following items will appear in the side menu.

- **Cut under**
- **Delete Even**
- **Delete Odd**
- **Shift Mag**

Cutting Extraneous Frequency Components

Here is the procedure for using the **Cut under** item to remove the extraneous frequency component.

 Cut under

Procedure

- Step 1:** Select **Limiter** from the bottom menu.
- Step 2:** Press the **CURSOR** button on the front panel to select the left/right vertical bar cursor. Using the numeric keys or the general purpose knob, set the domain to remove the extraneous frequency component.
- Step 3:** Press the **VALUE** button on the front panel. Using the general purpose knob or the numeric keys, set the limit level for the magnitude. The limit level is displayed at the top of the screen.
- Step 4:** Select **Cut under** from the side menu. The frequency component under the limit level is cut.

Deleting Even or Odd Components

Here is the procedure for using the **Delete Even** or **Delete Odd** item to delete the even component or odd component in the discrete frequency domain.

 Delete Even

 Delete Odd

Procedure

- Step 1:** Select **Limiter** from the bottom menu.
- Step 2:** Press the **CURSOR** button on the front panel to select the left/right vertical bar cursor. Using the numeric keys or the general purpose knob, set the domain to delete the even component or odd component.
- Step 3:** Select **Delete Even** (even) or **Delete Odd** (odd) from the side menu. The even or odd component within the left and right vertical bar cursors is cut.

Figure 4A-161 shows the fundamental, even, and odd component.

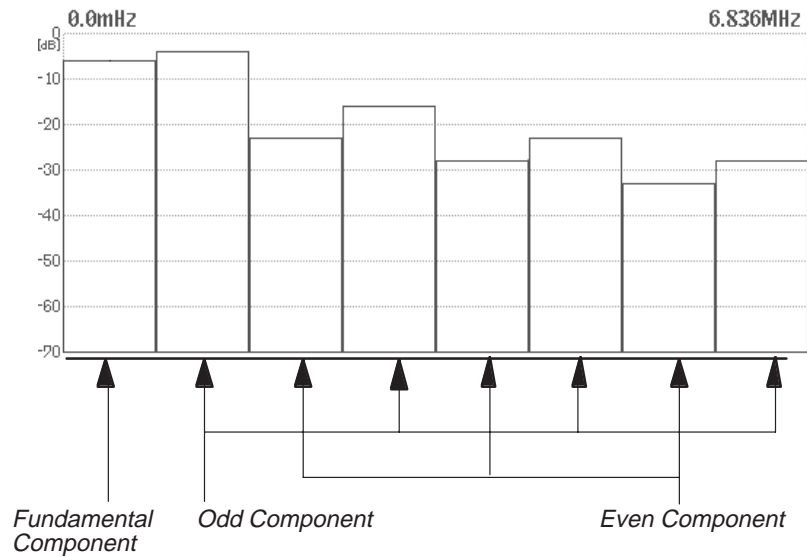

Figure 4A-161: Fundamental, Odd, and Even Components



Sifting Magnitudes

Here is the procedure for using the **Shift Mag** item to shift the magnitude to the limit level.

Procedure

- Step 1:** Select **Limit** from the bottom menu.
- Step 2:** Press the **CURSOR** button on the front panel to select the left/right vertical bar cursor. Using the numeric keys or the general purpose knob, set the domain to be used when shifting the magnitude.
- Step 3:** Press the **VALUE** button on the front panel. Using the general purpose knob or the numeric keys, set the limit level for the magnitude. The limit level is displayed at the top of the screen.
- Step 4:** Select **Shift Mag** from the side menu. The entire area within the left and right vertical bar cursors will shift so the signal with the maximum magnitude between the cursors becomes the limit level.

SETUP Menu

General Description

The **SETUP** menu is used to set a variety of output parameters used during actual output of the waveforms and sequence waveforms that have been created with the editors. The menu can display output parameter values and selected items in both text form and as a graphic (in other words, with items connected in the form of a circuit).

When the power to the instrument is turned on, the **SETUP** menu appears automatically. Also when the power is switched on, if you have select **from Disk** or **from NVRam** in the **Auto Load** item of the **LOAD/SAVE** menu, all the files on the disk or in the NVRam are loaded automatically into internal memory. If the waveform or sequence file being selected with the **SETUP** menu the last time you switched off the power exists in internal memory when you switch on the power, then that file will be selected.

The bottom menu consists of seven items: the six output parameters that you can set (**Clock, Waveform Sequence, Filter, Amplitude, Offset** and **Marker Level**) and the **Display** item which allows you to set the format for menu displays. To set these items, press the corresponding button in the bottom menu and use the general purpose knob or the numeric keys to set the desired value.

A waveform or sequence file that is created with the editor has the default output parameters set in it. When the output parameters are changed with the **SETUP** menu, the new settings are saved automatically together with the waveform data in the file.

If the file is locked, the output parameters can be changed, but the changes are not written to the waveform file. For further information on locking files, see "Locking and Unlocking Files" item in the section on editors.

When the operating mode is **Autostep**, the output parameters cannot be changed at all.

SETUP Menu Structure

Figure 4B-1 shows the configuration of the **SETUP** menu.

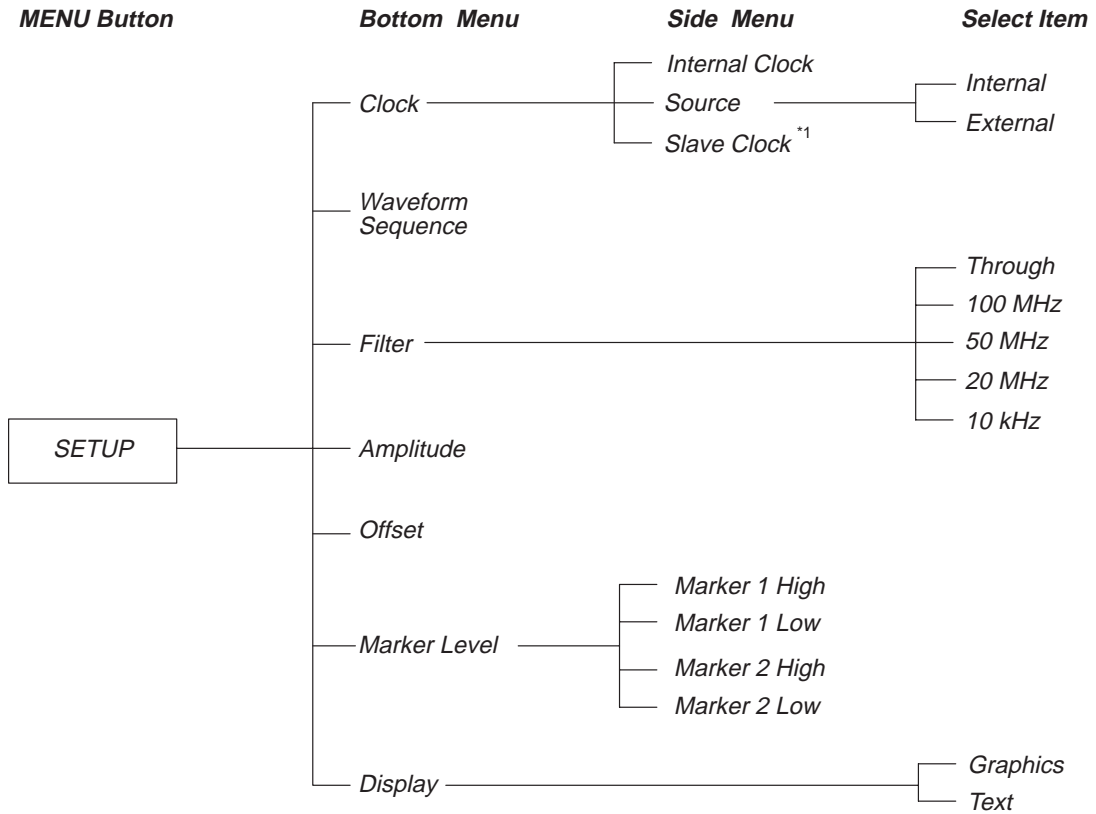

Figure 4B-1: SETUP Menu Structure

*1 This item appears in the menu only when **Slave** in the bottom menu is selected in the **MODE** menu. Under these circumstances, only this item is displayed in the side menu.

MENU Functions

The following table shows the function of each menu item and the page to refer to for a more detailed explanation.

Table 4B-1: Menu Functions

Menu	Function	Page
Clock	Setting clock source and frequency	4B-10
Waveform Sequence	Selecting a waveform or sequence file	4B-6
Filter	Setting filter	4B-12
Amplitude	Setting amplitude	4B-12, 4B-13
Offset	Setting offset	4B-12, 4B-13
Marker Level	Setting marker level	4B-14
Display	Selecting the display format for the SETUP menu	4B-5

SETUP Menu Display

Figure 4B-2 shows the graphic mode for **SETUP** menu display. A description for each callout follows.

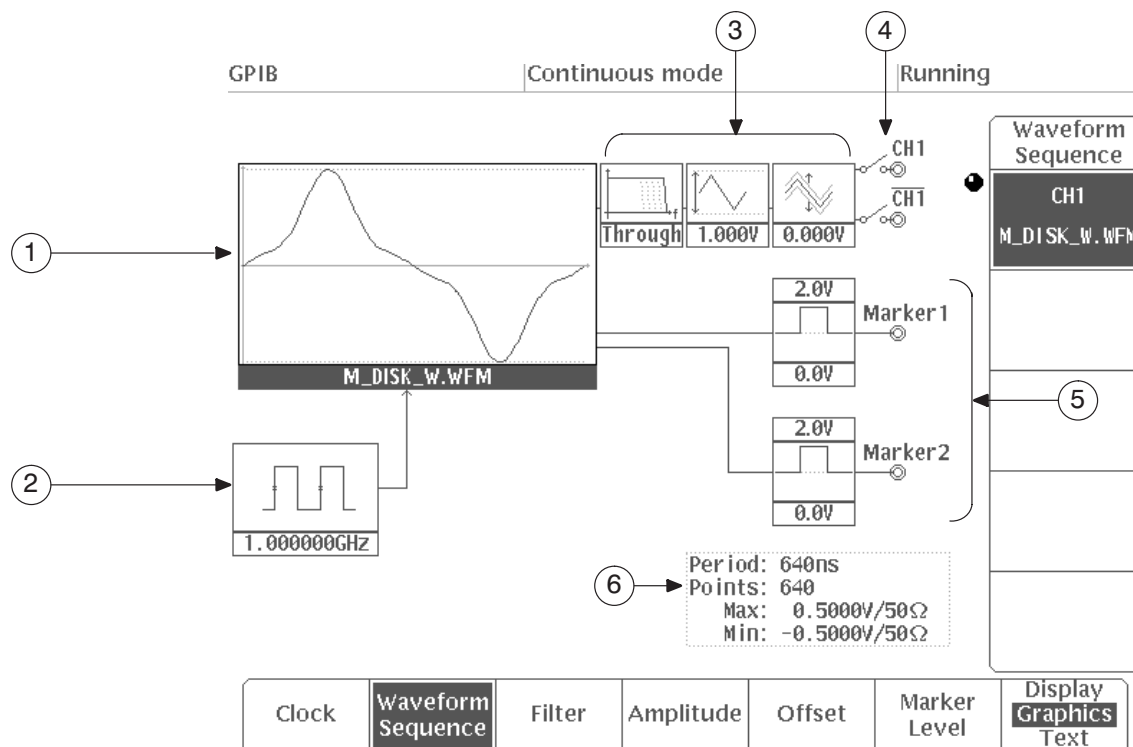

Figure 4B-2: SETUP Menu (Graphic Mode)

(1) Display Area for CH1 Waveform/Sequence Waveform

Shows the waveform or sequence file waveform indicated in the CH1 file input column. If the file is locked, an **L** is shown in the upper right-hand corner of this area.

(2) Clock Setting

Shows the display of the clock source or the frequency for the internal clock.

(3) CH1 Output Parameter Settings

Shows the filter applied to output, the amplitude of the output waveform and the offset setting.

(4) Channel Output On/Off

Shows whether channel output is on or off. To turn channel output on or off, use the channel **On/Off** button on the front panel.

(5) Marker Level Setting

Shows the high level/low level settings for **Marker1** and **Marker2**.

(6) Output Parameter Status

The output status of the waveform or sequence waveform is shown as follows:

Period :	Period
Points :	Number of data points
Max :	Upper voltage for full scale vertical axis when terminated with 50Ω
Min :	Lower voltage for full scale vertical axis when terminated with 50Ω

The period is the number of data points in the waveform or sequence, multiplied by the clock frequency.

Selecting the Display Format for the SETUP Menu

Display
Graphics
Text

The **SETUP** menu can be displayed in either graphic or text form.

Graphics — This is the mode normally used. This format displays the output parameters connected in the form of a circuit. Selected parameters are indicated by a inverted display around them; these values may be changed. See Figure 4B-2.

Text — This mode shows the output parameters in text form. Figure 4B-3 shows the **SETUP** menu displayed in text mode.

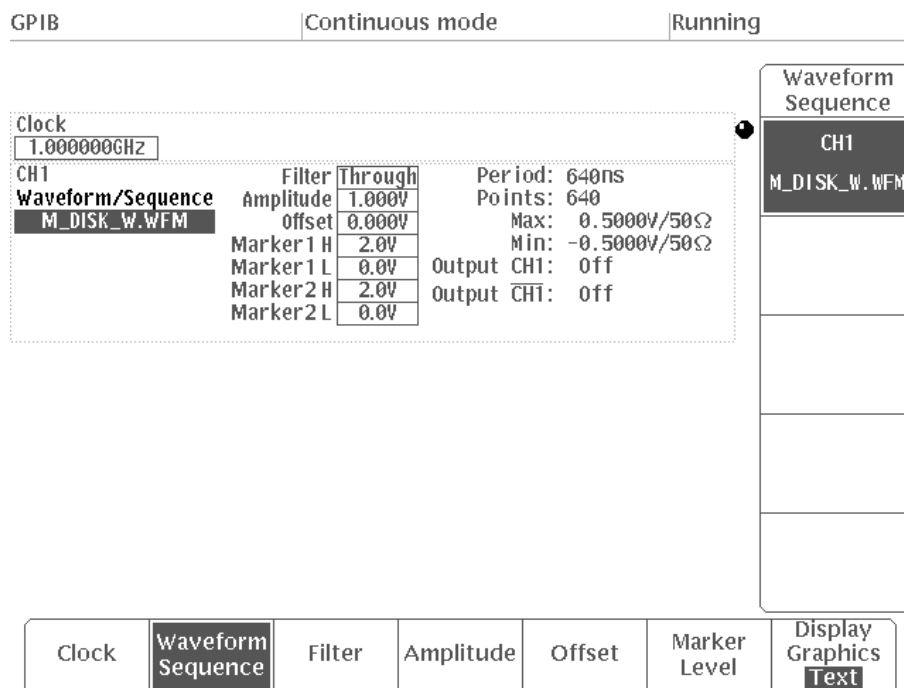

Figure 4B-3: SETUP Menu (Text Mode)

Selecting a Waveform or Sequence File

Waveform
Sequence

The first step in setting the waveform output parameters is to select the waveform or sequence file.

Each waveform or sequence file has output parameter settings attached to it. When a file is selected, the output parameters are also automatically changed to the settings for that file. A file newly created with the editor has the default output parameters set in it.

Clock	1 GHz (can also be set using the editor)
Filter	Through
Amplitude	1 V
Offset	0 V
Marker Level High	2 V
Marker Level Low	0 V

Procedure

To select a waveform or sequence file:

- Step 1:** Select **Waveform Sequence** from the bottom menu. The waveform display area will be highlighted on the screen.



- Step 2:** Turn the general purpose knob to open the file list. Use the general purpose knob to select the desired waveform or sequence file from the list.

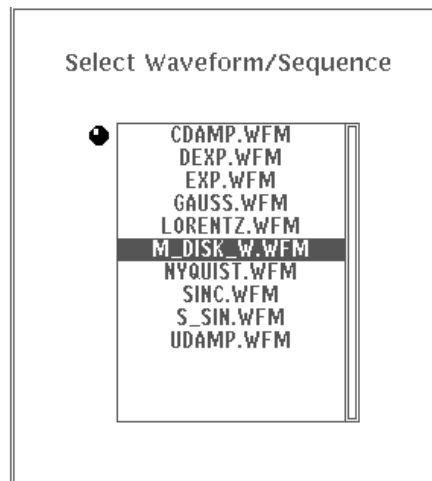

- Step 3:** After the file has been selected, select **O.K.** in the sub-menu. The selected file will be confirmed and the waveform and file name will appear in the icon, as shown in the figure below.

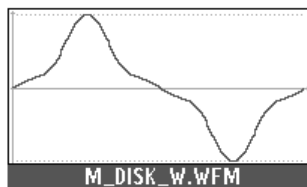

When the file is confirmed, the output parameters for that file will be set automatically. When a sequence file has been defined, the output parameters for all of the sequence files or waveforms making up that sequence are ignored and the output parameters for the defined sequence file are used.

NOTE. When a sequence file is selected, if the waveform or sequence file making up the sequence is not in internal memory, nothing is displayed in the waveform display area and the output switch is off. In this case, you must load the waveform or sequence file making up the sequence into internal memory.

Loading Waveform Files That Are Not a Multiple of 32

NOTE. The following explanation applies only when the **Hardware Sequencer** is off. When the **Hardware Sequencer** is on, waveforms with lengths that are less than 640 points, or are not a multiple of 32 points, cannot be loaded.

When creating or editing waveform files in the **EDIT** menu, if you attempt to save a file whose waveform size is not a multiple of 32, four choices will appear: **Append 0**, **Expand**, **Expand with Clock** and **Leave as it is**. With the first three items, the file size is converted to a multiple of 32 and the file is saved to internal memory. The last choice, **Leave as it is** does not alter the file size.

In the **SETUP** menu, when you select a file whose size is not a multiple of 32, data at the 0 point is added to the end of that waveform in waveform memory to make it a multiple of 32, after which the file is loaded. The following message is continuously displayed above the waveform display area:

Message : "Not multiple of 32 points, **added."

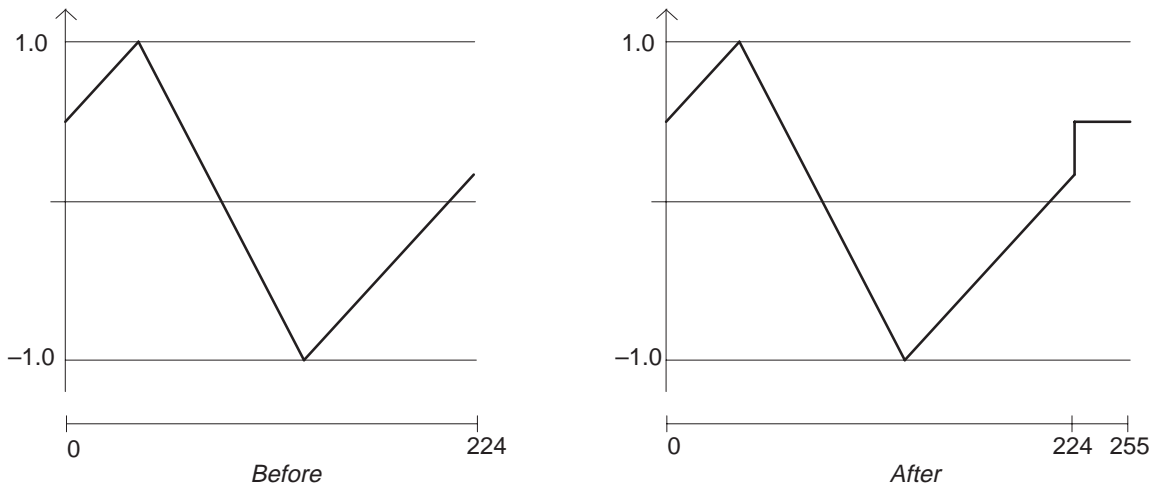

Figure 4B-4: Adding Data

In figure 4B-4, the waveform originally had 225 points. To make the length of the waveform a multiple of 32, additional points are written into waveform memory after the end of the waveform. In this case 31 additional points (numbers 225 to 255) are required. The additional points are given the same value as the first point in the waveform.

Loading Sequence Files in Waveform Advance Mode (Hardware Sequencer Off)

When the **Hardware Sequencer** is off and **Waveform Advance** in the **MODE** menu is selected, then when a sequence is loaded into waveform memory, the memory is divided up into segments which are all of equal length. The length of the segments will be equal to the smallest multiple of 32 that is big enough to contain the longest waveform in the sequence.

In the example given below, a sequence file called **AWG2041.SEQ** made up of the files shown in the table below has been loaded.

Sample Sequence File Contents



File Name	Waveform	Waveform Point Size
WAVE-1.WFM		1024
WAVE-2.SEQ		1024+1000
WAVE-3.WFM		500

Figure 4B-5 shows the resultant waveform when WAVE-1 through WAVE-3 are compiled into a single record with sequencer off.

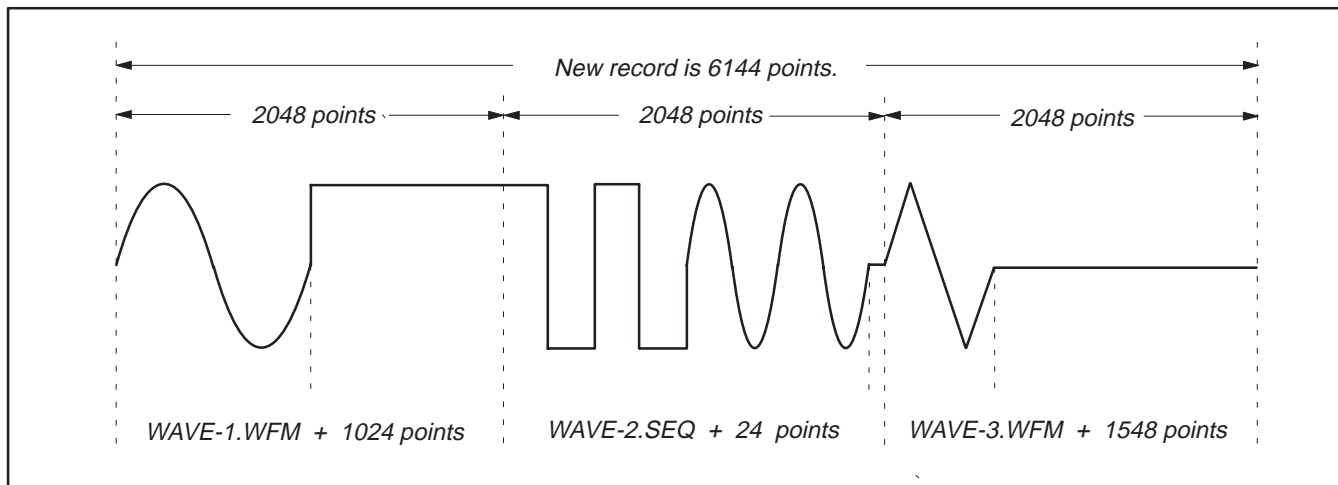

Figure 4B-5: Waveform Memory Divisions

Of the three waveforms shown above, the largest waveform file is the sequence file (**WAVE-2.SEQ**), measuring 2024 points. Notice that 24 points were added to this waveform to make 2048 points (a multiple of 32). Also notice the waveform memory is divided up into segments of 2048 point.

In the first segment, after the end of the **WAVE-1.WFM** data, 1024 points have been added, each with the same value as the first point of the next waveform (**WAVE-2.SEQ**). This method is used in all segments except the last: in the last segment there is no next waveform, so when additional points are required, they are given the value of the the first point in the first waveform in the sequence.

As can be seen from the above explanation, when **Waveform Advance** mode is selected and a sequence is loaded into memory, the memory required for the entire sequence is the number of waveforms times the length of a segment. Sometimes the required memory will be much more than the total of the number of points in all the waveforms.

NOTE. When the memory length required after data loading is greater than the waveform memory, the sequence file cannot be expanded into waveform memory. When such a file is already loaded into memory (with **Waveform Advance** mode off), **Waveform Advance** mode cannot be selected.

Loading Sequence Files in Waveform Advance Mode (Hardware Sequencer On)

In the hardware sequencer on state, when a sequence file is loaded to waveform memory with **Waveform Advance** in the **MODE** menu selected, waveforms are loaded into memory contiguously. Each waveform will have at least 640 points and have a length that is a multiple of 32 points.

Setting Clock Source and Frequency



The clock source and the clock frequency can be set using the **Clock** item. As a clock, you can choose either the internal clock generated in this instrument or an external clock input to the connector **CLK IN** on the rear panel. When you use the internal clock, you should also set the frequency of the internal clock generator using the **Internal Clock** item. When you use the external clock, there is no need to set the frequency .

The period of the waveform or the sequence waveform is determined by dividing the number of waveform points (refer to the **EDIT** menu) by the clock frequency (set in the **Internal Clock** item). For example, suppose that the clock frequency is 1 GHz and the number of waveform points is set to 1024, the period for the waveform to be generated will be 1024 nsec.

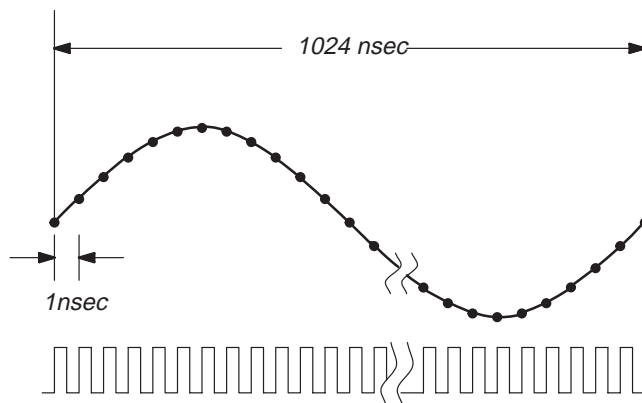

Figure 4B-6: Clock and Waveform Points

Procedure

To set **Clock**, perform these steps:

To set the Source to Internal and then set the clock frequency:

- Step 1:** Select **Clock** from the bottom menu.

- Step 2:** Press the **Source** button in the side menu and set it to **Internal**.
The clock icon shown below will be displayed on the screen.

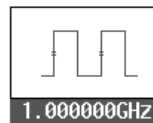

NOTE. If **Slave** (in the bottom menu) has been selected with the **MODE** menu, this will set the clock source to Slave Clock and the **Source** and **Internal Clock** items will not appear in the menu. To set either the external or internal clock, it is necessary to select a mode other than Slave in the **MODE** Menu.

- Step 3:** Use the numeric keys or general purpose knob to set the internal clock frequency.

The clock frequency can be set in the range between 1.000000 kHz and 1.024000 GHz.

To set the Source to External:

- Step 1:** Select **Clock** from the bottom menu.
- Step 2:** Press the **Source** button in the side menu and select **External**.
The clock icon shown below will be displayed on the screen.

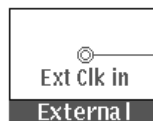

The period for the output waveform depends on the frequency of the external clock input from the **CLOCK IN** connector on the rear panel.

Setting Filter



The filters selections are: **100**, **50**, **20**, **10 MHz** and **Through**.

Procedure

To set **Filter**, perform these steps:

- Step 1:** Select **Filter** from the bottom menu. The filter icon will be highlighted on the screen.

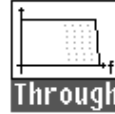

- Step 2:** Turn the general purpose knob to select the filter.

Setting Amplitude and Offset

Use **Amplitude** and **Offset** to set the output amplitude and offset for the vertical axis 8-bit full scale voltage. These values are terminated with 50Ω.

Figure 4B-7 shows the display when the amplitude is set to 1 V and the offset is set to 1 V.

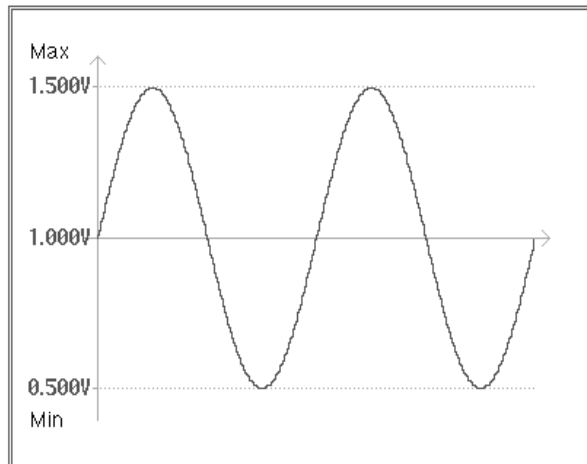

Figure 4B-7: Amplitude and Offset Setting

Setting the amplitude and offset determines **Max** and **Min** values shown to the left of the waveform. In the example shown in Figure 4B-7, the **Max** and **Min** values are as follows:

Max : 1.500V/50Ω
 Min : 0.500V/50Ω

Amplitude

Setting Amplitude

Procedure

- Step 1:** Select **Amplitude** from the bottom menu. The amplitude icon will be highlighted on the screen.



- Step 2:** Use the numeric keys or the general purpose knob to set the amplitude. The output amplitude can be set to any value between 0.020 V and 2.000 V in minimum increments of 1 mV.

NOTE. The amplitude set gives the top and bottom voltage values for the waveform editor full-scale in the waveform display area, not the peak-to-peak value of the waveform.

Offset

Setting Offset

Procedure

- Step 1:** Select **Offset** from the bottom menu. The offset icon will be highlighted on the screen.



- Step 2:** Use the numeric keys or the general purpose knob to set the desired offset. The offset may be set to any value between -1.000 V and $+1.000$ V in minimum increments of 1 mV.

Setting Marker Level

Marker
Level

There are two markers: **Marker1** and **Marker2**. Each of these can be set to either **High** and **Low** level. These voltages are values terminated with 50Ω.

For information on marker settings, see the section on the waveform editor. In the case of graphic display, these values are set with **Operation** (bottom menu) → **Marker...** (sub-menu). In the case of Timing display, these values are set with **Operation** (bottom menu) → **Set...** (sub-menu) → **Line**. In the case of table display, they are set with the cursor and the numeric keys.

Procedure

- Step 1:** Select **Marker Level** from the bottom menu.
- Step 2:** Select **Marker1 High** from the side menu. The **Marker1** icon will be highlighted on the screen.

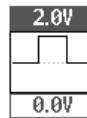

- Step 3:** Using the numeric keys or the general purpose knob, set the **Marker1 High** level. This value can be set anywhere between +2.0 V and -1.9 V in minimum increments of 0.1 V.
- Step 4:** Select **Marker1 Low** from the side menu. The **Marker1** icon will be highlighted on the screen.

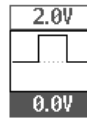

- Step 5:** Using the numeric keys or the general purpose knob, set the **Marker1 Low** level. This value can be set anywhere between +1.9 V and -2.0 V in minimum increments of 0.1 V.

NOTE. The high level will always be greater than the low level. Even if you attempt to set the high value below the low level, the low level will become lower to compensate.

Use the same procedure to set the level for **Marker2**.

MODE Menu

General Description

Press the **MODE** button in the **MENU** column to display the **MODE** menu. The **MODE** menu is used to set the operating mode for waveform output for the waveform whose output conditions have been set in the **SETUP** menu.

This menu contains items used for:

- setting the trigger mode for waveform or sequence waveform output
- setting the trigger mode for waveform output for individual files within sequence files and autostep files
- (when the AWG2041 is being used in parallel with other units) determining whether that AWG2041 instrument will be used as a master or slave unit.

The trigger and gate operations can be performed with external signals from the **TRIGGER INPUT** connector or by pressing the **MANUAL** button on the front panel.

Autostep operation is performed in response to an external signal supplied from the **AUTO STEP IN** connector on the rear panel, or when **Next Step** under **Config...** in the side menu is selected.

NOTE. When the AWG2041 is waiting for a trigger signal, the voltage for the first point of the waveform file to be output will be generated at the output terminals in accordance with the amplitude and offset settings.

When the trigger or gate signal becomes valid for this instrument, the "**Waiting for Trigger**" display in the status area of the CRT display changes to "**Running**" and the waveform or sequence is output. When output stops, the status area display returns to the original "**Waiting for Trigger**". These displays may not be able to keep up if the interval between trigger signals is short.

When the **MODE** button in the **MENU** column is pressed, a list appears showing the names of the waveforms or sequence files selected in the **SETUP** menu and the contents of the sequence files.

MODE Menu Structure

Figure 4C-1 shows the configuration of the **MODE** menu.

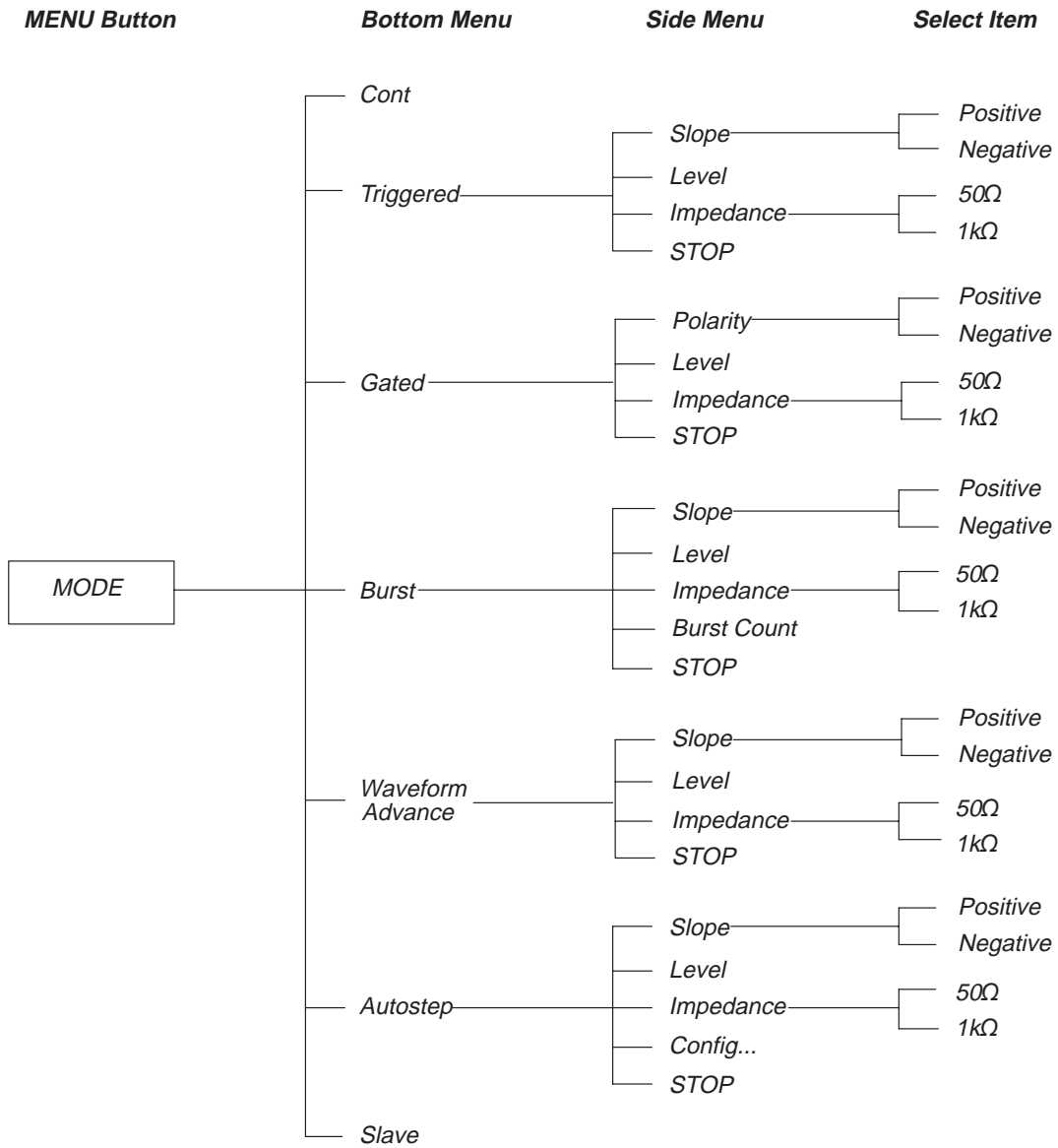

Figure 4C-1: MODE Menu Structure

Menu Functions

The following table describes the function of each of the menu items and gives the number of the page on which you can find a more detailed explanation of that item.

Table 4C-1: Menu Functions

Menu	Function	Page
Cont	Setting the operating mode	4C-6
Triggered		4C-6
Gated		4C-8
Burst		4C-9
Waveform Advance		4C-10
Autostep		4C-15
Slave		4C-20
Slope	Setting trigger parameters for an external trigger (gate)	4C-19
Polarity		4C-19
Level		4C-19
Impedance		4C-20
Burst Count	Number of bursts	4C-9
Config...	Starting an autostep program	4C-15
STOP	Stopping waveform output	4C-6

MODE Menu Display

Figure 4C-2 shows the general display for the **MODE** menu.

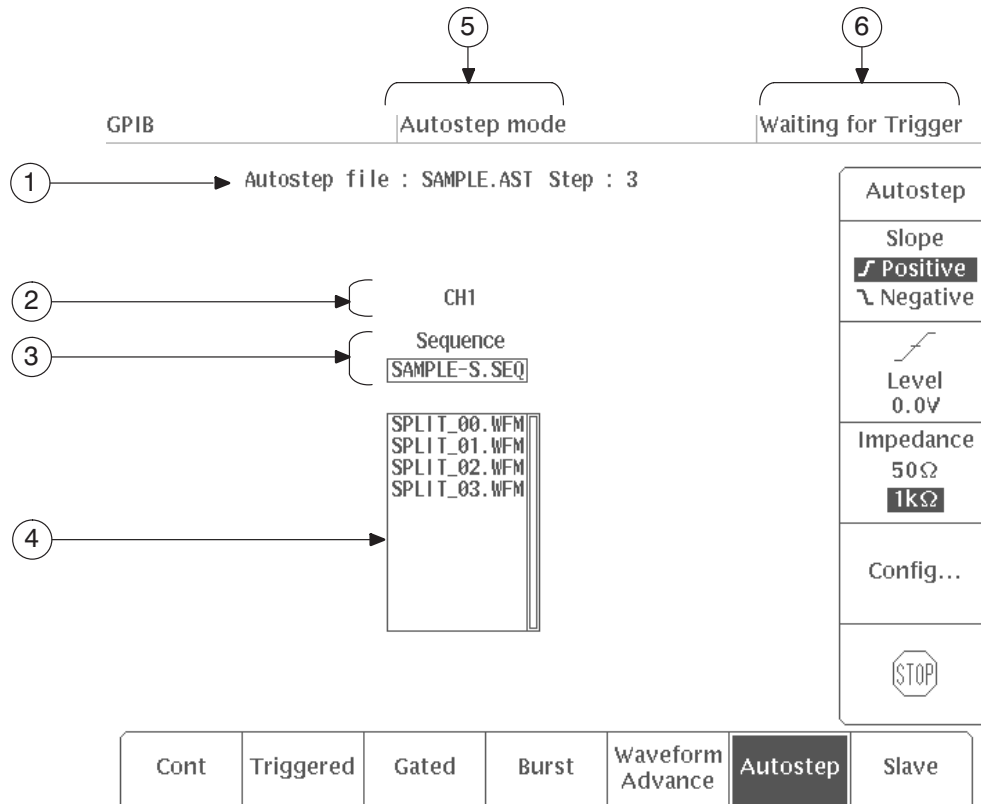

Figure 4C-2: MODE Menu CRT Display

(1) Autostep Files and Step Numbers

Shows the name of the currently selected autostep file and the step number for the file currently being output.

(2) Channel Display

Shows the channel for which the operating mode is to be set. On the AWG2041, only **CH1** is displayed.

(3) Waveform/Sequence

The name of the waveform or sequence file currently being output is shown. This waveform or sequence file is selected with the **SETUP** menu **Waveform Sequence** item.

For **Autostep** mode, the name of the waveform or sequence file for the current output step in the selected autostep file is shown.

(4) List

The contents of the waveform or sequence files specified in (3), above, are displayed. In **Waveform Advance** mode, the name of the file being output is displayed in the list inverted.

(5) Operating Mode Status

The operating mode set with the **MODE** menu is displayed. There are seven operating modes: **Cont**, **Triggered**, **Gated**, **Burst**, **Waveform Advance**, **Autostep** and **Slave**.

(6) Trigger Status

One of the following three trigger statuses is displayed in this column.

Stopped

Displayed when no waveform or sequence file has been selected with the **SETUP** menu.

Waiting for Trigger

Displayed when the waveform or sequence file has been selected with the **SETUP** menu and the system is waiting for the trigger or gate signal.

Running

Displayed when the trigger or gate signal is generated and the waveform is output.

Setting the Operating Mode

Select the operating (output) mode – either: **Cont**, **Triggered**, **Gated**, **Burst** trigger mode, **Waveform Advance mode**, **Autostep** mode, or **Slave** mode – by pressing the corresponding button in the bottom menu.

NOTE. When the hardware sequencer is on, the **Burst** item is not displayed and cannot be selected. The hardware sequencer on/off state is set using the following sequence of selections and button presses: **UTILITY (MENU)** → **Misc (bottom)** → **Config... (side)** → **Change Sequence Mode (sub)**.

The operation of **Waveform Advance** mode will differ depending on the hardware sequencer on/off state. See page 4C-10 for an explanation of **Waveform Advance** mode.

As the operating modes in function waveform generation (**FG**) mode is only continuous output, the operating mode set with the **MODE** menu has no effect on operating mode for function waveform generation mode.



In the operating mode excluding **Cont**, if the side menu **STOP** item is selected during waveform output, the output is stopped immediately and the instrument assumes a state in which it can restart the waveform from the beginning. The exact details of what happens after **STOP** is selected depend on which operating mode is selected. For each operating mode further details are given below in the sections for each mode.

The same thing will happen if an external signal is applied through the **STOP TRIG IN** connector on the rear panel.

Here is how each operating mode works.

Cont Mode



As soon as **Cont** mode is selected, continuous output of the specified waveform or sequence waveform begins. No side menu is displayed while **Cont** is selected.

Triggered Mode



In **Triggered** mode, the designated waveform or sequence waveform is output once for each trigger received.

When this instrument goes into **Triggered** mode, it waits for a trigger to be generated. The trigger can be generated from the external trigger signal applied to the **TRIGGER INPUT** connector or by pressing the **MANUAL** button on the front panel. During waveform output, if the **MANUAL** button is pressed or the external trigger signal is generated, such a trigger has no effect.

When **Triggered** is selected, the following items will be displayed in the side menu:

- **Slope**
- **Level**
- **Impedance**
- **STOP**

The **Slope**, **Level** and **Impedance** items are used to set the trigger conditions for the external trigger signal.

Figure 4C-3 shows the output for an external trigger signal.

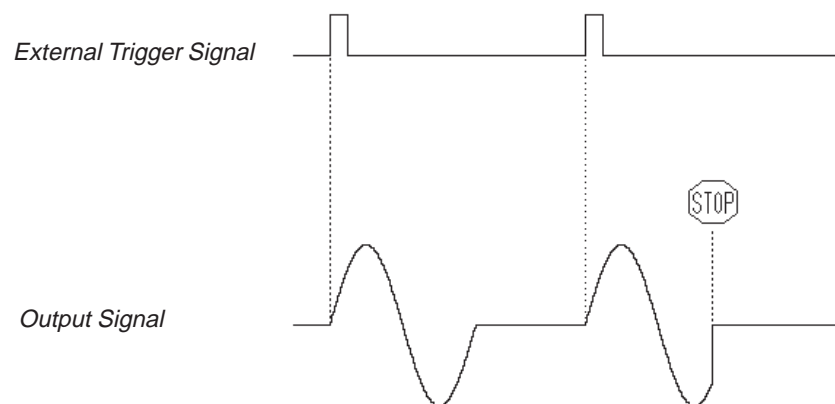

Figure 4C-3: Output for External Trigger Signal in Triggered Mode

Selecting **STOP** in the side menu during waveform output causes waveform output to stop immediately. After that, the voltage for the first point in the waveform is output continuously (See Figure 4C-3). When a sequence file has been designated in the **SETUP** menu, the continuously output voltage is the voltage of the first point of the first waveform in the sequence file.

NOTE. When a waveform is outputting or the instrument is waiting for a trigger, and the **STOP** menu button is pressed, or a **STOP** command is received via the GPIB, or a signal is received at the **STOP TRIGGER IN** connector on the rear panel, the instrument may output a spurious pulse.

Gated

Gated Mode

Use **Gated** mode to control waveform or sequence output with a gate signal.

When this instrument goes into **Gated** mode, it waits for a gate to be generated. The gate signal is generated while the external gate signal (applied through the **TRIGGER INPUT** connector) is valid, or while the **MANUAL** button on the front panel is held down.

In the case of the waveform output using the **MANUAL** button, while the **MANUAL** button on the front panel is pressed, the specified waveform or sequence is output. When you let the **MANUAL** button go, the waveform output stops. When you press the **MANUAL** button again, the waveform or sequence output resumes from the level where it left off. While you are pressing the **MANUAL** button, if you press any other button, the instrument goes into the mode for the **MANUAL** button not being pressed.

In the case of waveform output using an external gate signal, the designated waveform or sequence waveform is output while the external gate signal (being applied through the **TRIGGER INPUT** connector) is valid. Waveform output stops as soon as the external gate signal becomes invalid. At the next external gate signal, the waveform or sequence resumes from the waveform level at which it was kept stopped.

When **Gated** is selected, the following items will be displayed in the side menu:

- **Polarity**
- **Level**
- **Impedance**
- **STOP**

The **Polarity**, **Level** and **Impedance** items are used to set the gate conditions for the external gate signal.

Figure 4C-4 shows the output for an external gate signal.

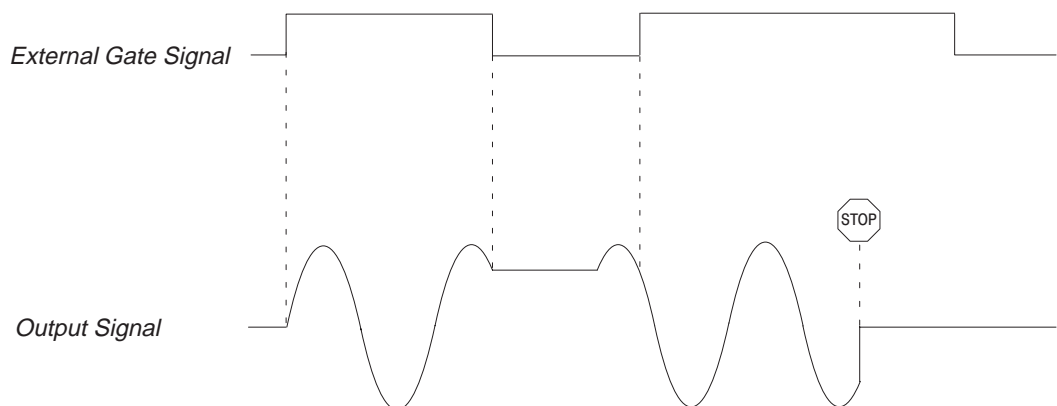

Figure 4C-4: Output for External Gate Signal in Gated Mode

Selecting **STOP** in the side menu during waveform output causes waveform output to stop immediately. After that, the voltage for the first point in the waveform is output continuously (See Figure 4C-4). When a sequence file has been designated in the **SETUP** menu, the continuously output voltage is the voltage of the first point of the first waveform in the sequence file.

Burst Mode

Burst

NOTE. *Burst mode can be selected only when the hardware sequencer is off. The hardware sequencer on/off state is set with the following sequence of presses and selections: **UTILITY** (MENU) → **Misc** (bottom) → **Config...** (side) → **Change Sequence Mode** (sub). When the hardware sequencer is on, the **Burst** item is not displayed in the **MODE** menu and cannot be selected.*

In **Burst** mode, when a trigger signal is generated, the designated waveform or sequence waveform is output the number of times specified with the **Burst Count** item.

When this instrument goes into **Burst** mode, it waits for a trigger to be received. The trigger can result from an external trigger signal being applied to the **TRIGGER INPUT** connector, or pressing the **MANUAL** button on the front panel, or the GPIB STOP command. Triggers received when a waveform is outputting have no effect.

When **Burst** is selected, the following items will be displayed in the side menu:

- **Slope**
- **Level**
- **Impedance**
- **Burst Count**
- **STOP**

The **Slope**, **Level** and **Impedance** items are used to set the trigger conditions for the external trigger signal.

Burst Count

Use **Burst Count** to set how many times the waveform or sequence waveform will be output when a trigger signal is applied.

Figure 4C-5 shows an example of the output in response to an external trigger signal when **Burst Count** has been set to 3.

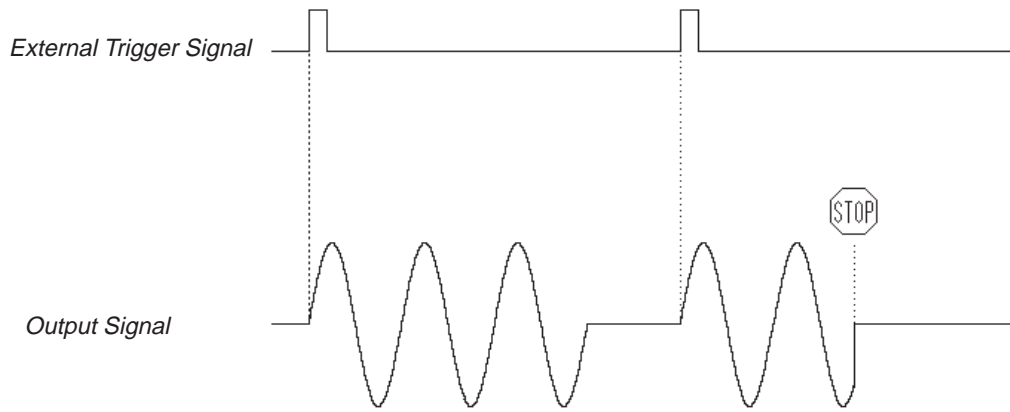

Figure 4C-5: Output for External Trigger Signal in Burst Mode

Selecting **STOP** in the side menu during waveform output causes waveform output to stop immediately. After that, the voltage for the first point in the waveform is output continuously (See Figure 4C-5). When a sequence file has been designated in the **SETUP** menu, the continuously output voltage is the voltage of the first point of the first waveform in the sequence file.

NOTE. When a waveform is outputting or the instrument is waiting for a trigger, and the **STOP** menu button is pressed, or a **STOP** command is received via the GPIB, or a signal is received at the **STOP TRIGGER IN** connector on the rear panel, the instrument may output a spurious pulse.

Waveform Advance

Waveform Advance Mode

When a sequence file has been designated in the **SETUP** menu, **Waveform Advance** mode can be used to cause progression to the next waveform in the sequence each time a trigger is received.

The number of repetitions set with **Repeat** in the sequence editor will be ignored. When the hardware sequencer is off, each waveform is output once; when the hardware sequencer is on, each waveform is output continuously until the next trigger is received. The hardware sequencer on/off state is controlled by **UTILITY (MENU) → Misc (bottom) → Config... (side) → Change Sequencer Mode (sub)**.

The same output parameters (amplitude, offset, clock and filter in the **SETUP** menu) will be used for output of all of the waveforms in the sequence file.

When the instrument goes into **Waveform Advance** mode, it waits for a trigger to be generated. This trigger can be generated from the external trigger signal applied to the **TRIGGER INPUT** connector or by pressing the **MANUAL** button on the front panel.

When **Waveform Advance** is selected, the following items will be displayed in the side menu:

- **Slope**
- **Level**
- **Impedance**
- **STOP**

The **Slope**, **Level** and **Impedance** items are used to set the trigger conditions for the external trigger signal.

NOTE. When you change the hardware sequencer mode, the files in the catalog memory of the instrument are lost. Before changing the hardware sequencer mode, save the files that you do not want to lose in the instrument's nonvolatile memory or a floppy disk.



Hardware Sequencer Off

Each time a trigger is received, the current waveform is output once only, and the instrument advances to the next waveform.

NOTE. When a sequence file is expanded into waveform memory in this mode, the waveform memory will be divided into segments where the length of each segment is the smallest multiple of 32 that is longer than the longest waveform in the sequence file. The total memory length needed will be the segment length multiplied by the number of files in the sequence file. When the total length is longer than the waveform memory, the sequence file cannot be expanded into waveform memory. See "Selecting a Waveform or Sequence File" in Section 4B "SETUP Menu."

Figure 4C-6 shows an example of the output in response to an external trigger signal when a sequence file with the attributes shown in the table below has been selected in the **SETUP** menu.

Sample Sequence File Contents

File Name	Waveform	No. of repetitions	Output Conditions
WAVE-1.WFM		1	Amplitude 2.0 V Offset 0 V
WAVE-2.SEQ		3	
WAVE-3.WFM		2	

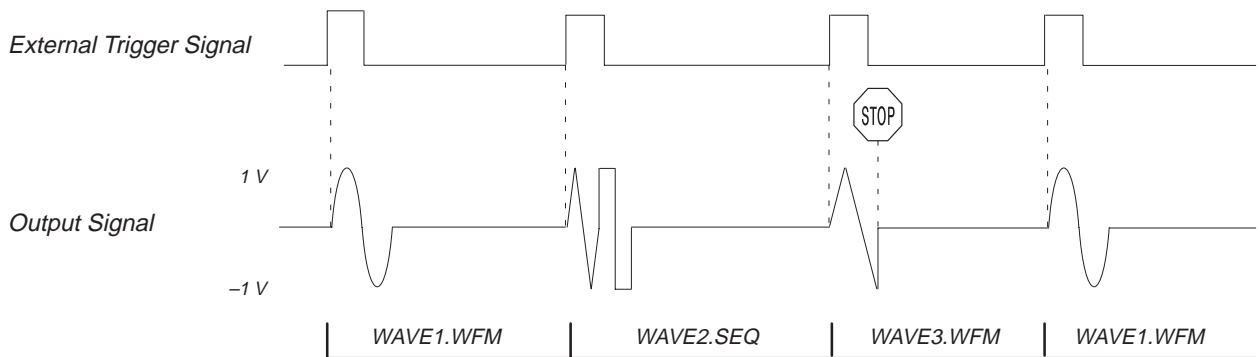

Figure 4C-6: Output for External Trigger Signal in Waveform Advance Mode (Hardware Sequencer Off)

Output

- After the output of a waveform has finished, the voltage of the first point of the next waveform is output. This voltage is maintained until a trigger signal is applied. If the waveform is the last waveform in the sequence, the continuously output voltage is the voltage of the first point of the first waveform in the sequence.
- Selecting **STOP** in the side menu during waveform output causes waveform output to stop immediately, and the voltage of the first point of the first waveform in the sequence to be output continuously. When the next trigger is received, the first waveform in the sequence will be output.
- The same output parameters (amplitude, offset, clock and filter) are used for output of all waveforms in the sequence file.
- The number of repetitions for the waveforms in the sequence file are ignored; each waveform is output once only.





- Also, if the sequence file contains another sequence file, the other sequence will be output only once. However, the repetitions for the waveforms within the other sequence are not ignored: each waveform within the other sequence will be output the number of times specified by its repetition number.

Hardware Sequencer On

After **Waveform Advance** has been selected, the instrument waits for a trigger. On receiving the first trigger, the first waveform in the sequence file is output continuously. On receiving subsequent triggers, the instrument finishes output of the current waveform, and advances to the next waveform in the sequence file. Consequently, there will be a delay between the trigger and the start of the next waveform while the current waveform finishes.

Figure 4C-7 shows an example of the output in response to an external trigger signal when a sequence file with the attributes shown in the table below has been selected in the **SETUP** menu.

Sample Sequence File Contents

File Name	Waveform	No. of repetitions	Output Conditions
WAVE-1.WFM		1	Amplitude 2.0 V Offset 0 V
WAVE-2.SEQ	 + 	3	
WAVE-3.WFM		2	

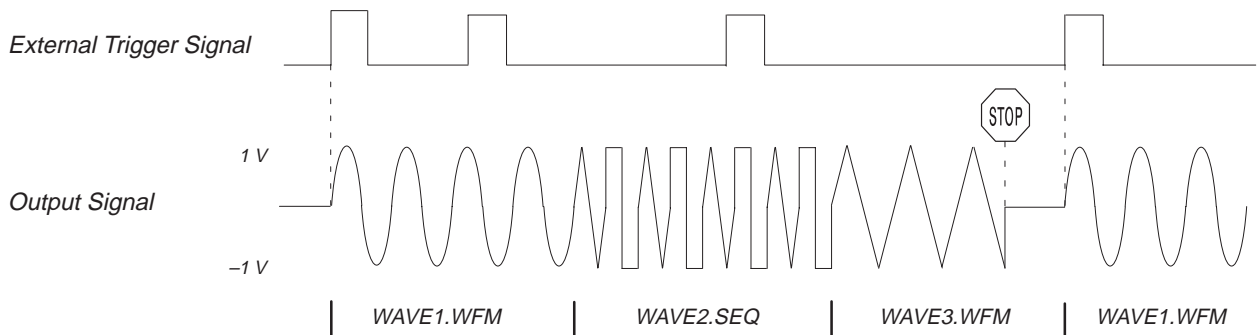

Figure 4C-7: Output for External Trigger Signal in Waveform Advance Mode (Hardware Sequencer On)

Output

- Selecting **STOP** in the side menu during waveform output causes waveform output to stop immediately, and the voltage of the first point of the first waveform in the sequence to be output continuously. When the next trigger is received, the first waveform in the sequence will be output.
- The same output parameters (amplitude, offset, clock and filter) are used for output of all waveforms in the sequence file.
- The number of repetitions for the waveforms in the sequence file are ignored; and each waveform is output continuously.
- Also, if the sequence file contains another sequence file, the other sequence will be output continuously. However, the repetitions for the waveforms within the other sequence are not ignored: each waveform within the other sequence will be output the number of times specified by its repetition number.
- When a trigger is received, the output of the current waveform is finished before advancing to the next waveform. If, while the waveform is being finished, a second trigger is received, the next waveform is output completely just once, and then the instrument advances to the waveform after next. See Figure 4C-8 for an example.

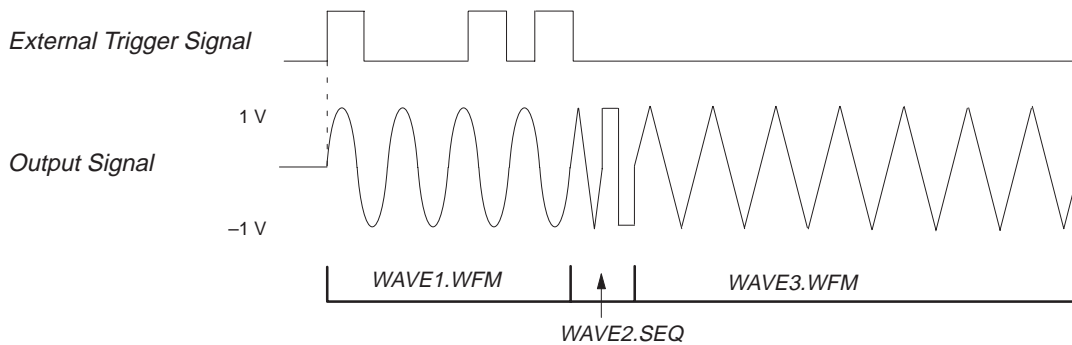

Figure 4C-8: Output for External Trigger Signal in Waveform Advance Mode (Hardware Sequencer On)

In Figure 4C-8, the contents of the sequence file are the same as in Figure 4C-7.

Autostep

Autostep Mode

Use **Autostep** mode to start an autostep file created with the **EDIT** menu Autostep editor. An autostep file stores a program that specifies a waveform or sequence file and output parameters (clock frequency, amplitude, filter, etc.) for each step.

In **Autostep** mode, when a step signal is received, the waveform or sequence waveform for the next step is loaded into waveform memory and output when the trigger signal is received. The waveform for each step can be output continuously or once only, depending on the setting for the **Run** output parameter. The output parameters will also change for each step.

The **Autostep** mode step signal can be generated from the **AUTO STEP IN** connector or by pressing the **Next Step** button in the **Config...** sub-menu.

Just as in other operating modes, the **Autostep** mode trigger signal can be generated from the **INPUT** connector on the front panel or by pressing the **MANUAL** button on the front panel.

NOTE. During **Autostep** mode, the output parameters can not be changed with the **SETUP** menu.

When **Autostep** is selected, the following items will be displayed in the side menu:

- **Slope**
- **Level**
- **Impedance**
- **Config...**
- **STOP**

The **Slope**, **Level** and **Impedance** items are used to set the trigger conditions for the external trigger signal.

Starting an Autostep Program

Config...

Use **Config...** to select autostep files and set output conditions and to proceed to the next step. The following diagram shows the menu configuration for the **Config...** item.

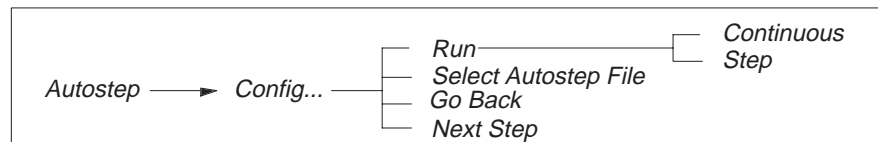

Procedure

- Step 1:** Select **Autostep** from the bottom menu.
- Step 2:** Select **Config...** from the side menu.
- Step 3:** Choose **Select Autostep File** from the sub-menu. When this item is selected, the list of autostep files created with the autostep editor is displayed. See Figure 4C-9.

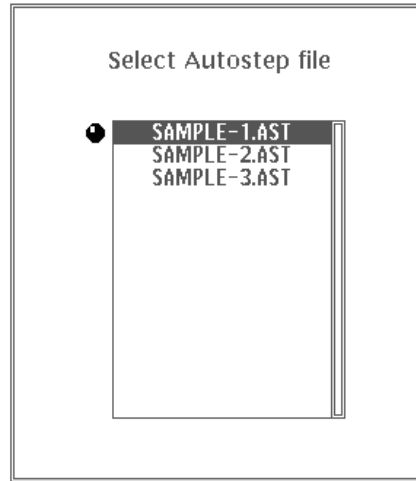

Figure 4C-9: Autostep File List

- Step 4:** Use the general purpose knob to select the file to open from the displayed list of autostep files.
- Step 5:** After selecting the file, to confirm the selection, select **O.K.** from the sub-menu. To cancel the file selection, select **Cancel**. When you select **O.K.**, the autostep program opens.
- Step 6:** Press **Run** in the sub-menu and select either **Continuous** or **Step**.

Continuous – When a trigger signal is received, the waveform for the current step is output repeatedly. To stop the continuous output, change temporarily to **Step**. Selecting **STOP** from the side menu will also stop the output, but this will also return the current step to **Step 1**.

Step – When a trigger signal is received, the waveform for the current step is output once only. Each time a trigger signal is received, the current waveform is output once. While waveform output is in progress, even if the next trigger signal is received, it is ignored.
- Step 7:** Press the **Manual** button on the front panel to generate the trigger signal. The waveform for the current step will be output in accordance with the **Run** setting.

- Step 8:** Select **Next Step** from the sub-menu to proceed to the next step.

When a step signal is received during waveform output, output for the current step will stop at the end of that waveform and the waveform for the next step will be loaded into waveform memory and the AWG2041 will wait for the trigger signal.

- Step 9:** Repeat Steps 7 and 8 to output the waveforms for each step.



At the last step, selecting **Next Step** will cause the AWG2041 to return to the **Step:1** waveform.

- Step 10:** Select **Go Back** from the sub-menu. The side menu for the **Autostep** menu item will reappear.

- Step 11:** To return from the current step to the first step, select **STOP** in the side menu. The same thing will happen when a stop signal is received through the **STOP TRIG IN** connector on the rear panel.

Figure 4C-10 shows an example of the output in response to the external trigger signal for both **Run** settings (**Continuous** and **Step**), when an auto-step file with the attributes shown in the table below has been selected with the **Autostep** menu item.

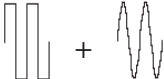
Sample Autostep File Contents

Step	Waveform	File Name	Output Conditions
Step:1		WAVE-1.WFM	Amplitude 1.5 V Offset 0 V
Step:2		WAVE-2.SEQ	Amplitude 1.0 V Offset 0 V
Step:3		WAVE-3.WFM	Amplitude 2.0 V Offset 0 V

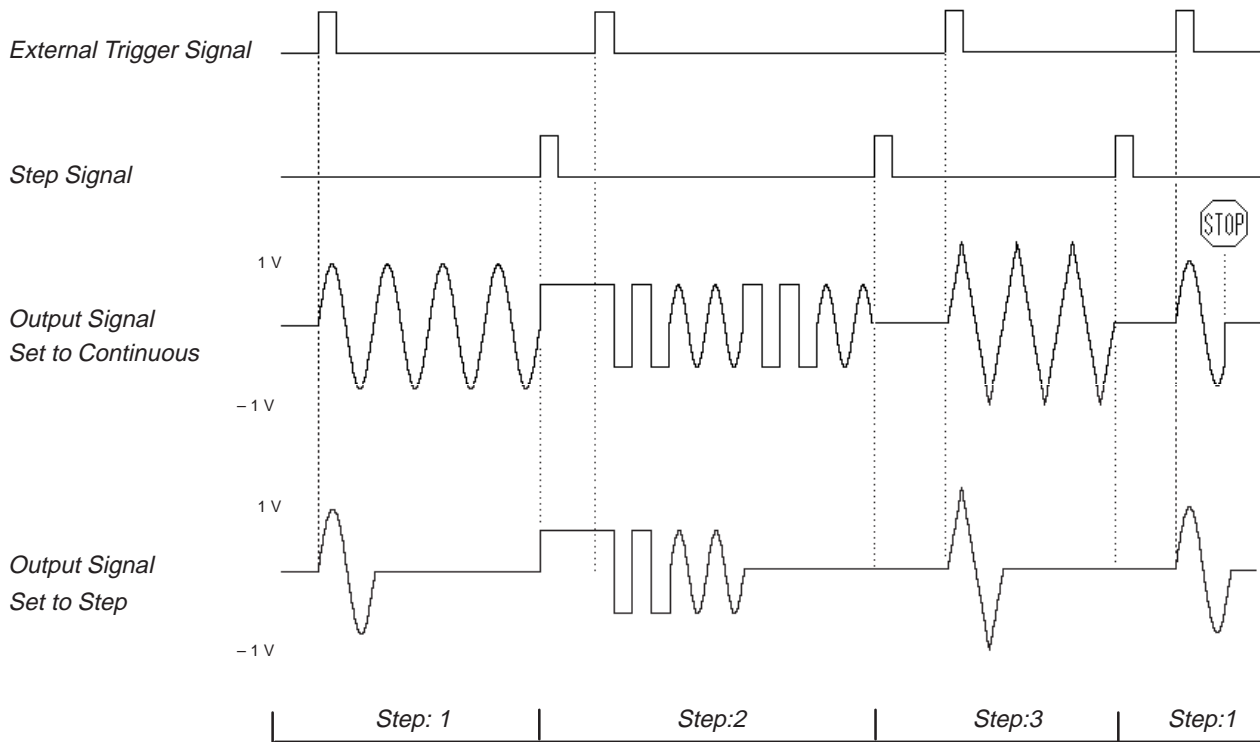

Figure 4C-10: Output in Response to External Trigger Signal (when Run is set to Continuous and Step)

Output

- When a trigger signal is applied, if **Run** is set to **Continuous**, the waveform will be output continuously. If **Run** is set to **Step**, the waveform will be output once only. This autostep file contains a sequence file consisting of two waveform types combined in a sequence; in this case, the values for number of repetitions set for the individual waveforms are ignored.
- When a step signal is generated, the next waveform is loaded into waveform memory and the voltage for the 0 point of that waveform is generated; this voltage is maintained until the trigger signal is applied.
- Selecting **STOP** in the side menu during waveform output will cause waveform output to stop at that point. The **STOP** signal will also cause the current step to return to the **Step:1** waveform.
- The waveforms for each step in the autostep file are output in accordance with the output parameters (amplitude, offset, clock and filter) set for each step in the autostep editor.

Setting Trigger Parameters for an External Trigger (gate)

The external trigger (gate) signal is input from the **TRIGGER INPUT** connector on the front panel.

Use the **Slope**, **Polarity**, **Level** and **Impedance** items in the side menu of the **MODE** menu to set trigger (gate) parameters for an external trigger (gate) signal.

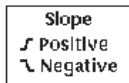

Slope

This item sets the slope for the external trigger signal. Press the **Slope** button in the side menu and select either **Positive** or **Negative**. When **Positive** is selected, the output is triggered at the rising edge of the external trigger signal; when **Negative** is selected, the output is triggered at the falling edge of the external trigger signal.

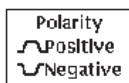

Polarity (Gated mode)

This item sets the polarity for the gate that outputs the waveform or sequence with an external gate signal. Press the **Polarity** button in the side menu and select either **Positive** or **Negative**. When **Positive** is selected, the waveform or sequence is output while the level of the gate signal is higher than the gate level set with the side menu **Level** item. When **Negative** is selected, the waveform or sequence is output while the level of the gate signal is lower than the set gate level.



Level

This item sets the trigger (gate) level for an external trigger (gate) signal. Press the **Level** button in the side menu, then set the level with the numeric keys or the general purpose knob. The trigger (gate) level can be set in the range -5.0 V to 5.0 V in steps of 0.1 V .

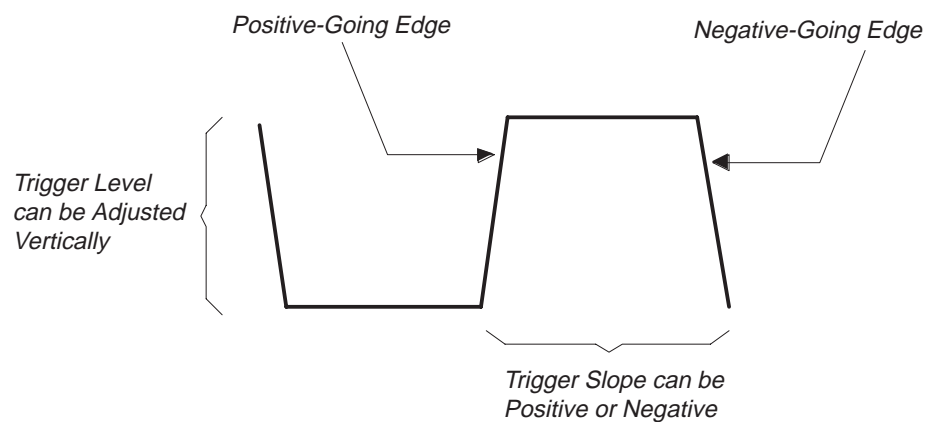

Figure 4C-11: Slope and Level Controls

Impedance
50Ω
1kΩ

Impedance

Either of two values (1 kΩ or 50Ω) can be selected for the input impedance when the external trigger (gate) signal is entered. The maximum input voltage will be ±10 V when the input impedance is 1 kΩ and ±5 V when the input impedance is 50Ω. The trigger signal is entered through the **TRIGGER INPUT** connector on the front panel.

Slave Mode

Slave

A cable is used to connect the **MASTER CLOCK OUT** connector on the rear panel of the master AWG2041 with the **SLAVE CLOCK IN** connector on the rear panel of the slave AWG2041. The clock signal causes the slave unit to operate synchronously with the master unit. Connecting a slave unit will cause the number of output channels to increase. The clock signal received from the master unit is output from the **MASTER CLOCK OUT** connector on the slave unit.

When AWG2041 instruments are connected in parallel, loop-through connection should be used, as shown in Figure 4C-12.

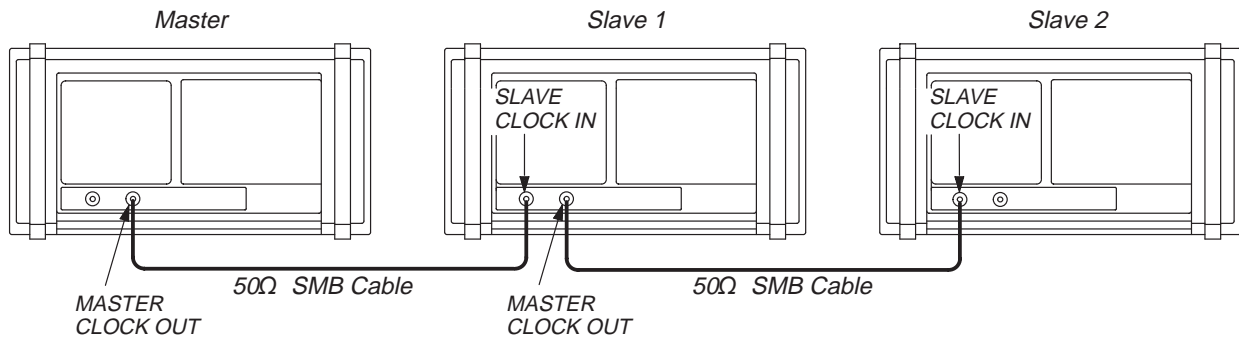

Figure 4C-12: AWG2041 Synchronous Operation

NOTE. Each meter of the 50Ω SMB cable has delay of around 5 ns, so the cables used to connect clock output and clock input should be as short as possible.

Synchronous operation is possible in **Triggered, Gated, Burst** and **Waveform Advance** modes. It is not possible in **Continuous** and **Autostep** modes.

NOTE. In order to perform synchronous operation, waveforms with the same point size must be present on both master and slave units. In addition, the clock on the master unit should be at least 650 MHz. The waveform will not be correctly output with clocks lower than this.

When **Slave** in the bottom menu is selected, that instrument will function as a slave unit. To return that instrument to master operation, select an operating mode other than **Slave** (for example, **Cont**, **Triggered**, etc.).

NOTE. When you change to slave mode, the clock on the master unit must be turned off. First change the mode to **slave** mode and then input the trigger signal to the master unit.

Master

When using the AWG2041 as a master unit, you should set the operating mode to **Triggered**, **Gated**, **Burst** or **Waveform Advance**.

Slave

The unit is operated in the same mode as the master unit. It also operates synchronously with the Trigger, Gate and stop signals generated by the master unit. By selecting **Slave** for the operating mode, the clock setting in the **SETUP** menu is also set to **Slave** automatically.

LOAD/SAVE Menu

General Description

Press the **LOAD/SAVE** button in the **MENU** column to display the **LOAD** or **SAVE** menu. Press the **Load** or **Save** button in the bottom menu to display the desired menu.

Use the **LOAD** menu to load files into internal (random access) memory from the instrument's internal non-volatile RAM memory (**NVRam**), from a floppy disk (**Disk**), or from another instrument through the **GPIB** interface.

NOTE. *In this section, the internal nonvolatile memory and the floppy disks are referred to as mass memory.*

The **SAVE** menu provides the opposite function, the ability to save files from internal memory of the instrument to mass memory.

NOTE. *When a sequence file is loaded or saved with the **LOAD/SAVE** menu, the waveforms and sequence files used in that sequence file are also loaded or saved.*

Memory Capacity

When you exit from the **EDIT** menu, the files you created with the editors are saved into the AWG2041 internal memory (RAM). Up to 400 files (depending on size) can be saved in the internal memory.

NOTE. The data in this instrument's internal memory is lost when the power is switched off. Therefore, you must save any necessary data to mass memory.

Like internal memory, the AWG2041 internal nonvolatile memory (NVRam) can hold up to 400 files. The NVRam has 512 Kbytes, almost all of which is used for saving files. The contents of this memory are retained even when the power is switched off.

The capacity of a floppy disk depends on its format. Disks can use directory hierarchies and files can be stored in each of the directories. The extension for a directory is **DIR**. For further information on creating directories, see the explanation in "Using the Disk Menu" in Section 4E, "UTILITY Menu."

Figure 4D-1 shows the relationship for loading and saving among the different types of memory.

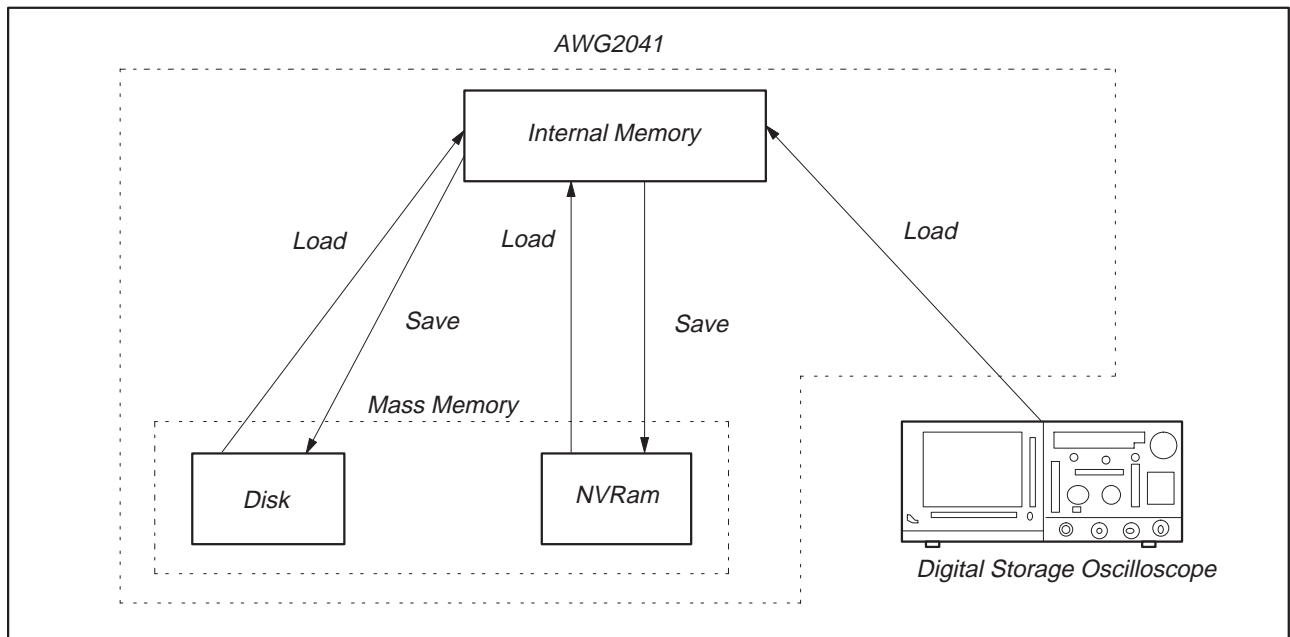

Figure 4D-1: Relationship Between Memory and Execution of Load/Save

LOAD/SAVE Menu Structure

Figure 4D-2 shows the configuration of the **LOAD/SAVE** menu.

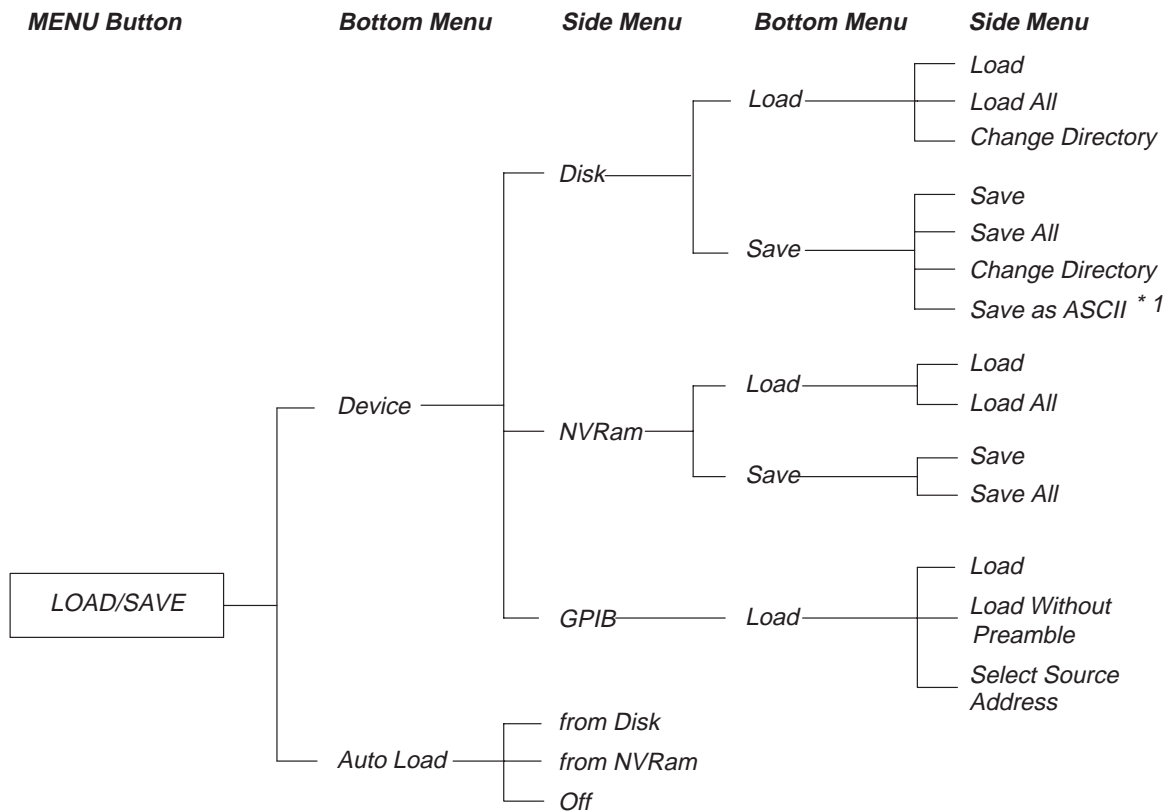

Figure 4D-2: LOAD/SAVE Menu Structure

*1 This item is displayed when an equation file (.EQU) has been selected in the list of files contained in the instrument's internal memory.

Menu Functions

The following table describes the function of each of the menu items and gives the number of the page on which you can find a more detailed explanation of that item.

Table 4D-1: Menu Functions

Menu	Function	Page
Device	Selecting the device	4D-6
Load	Loading files from mass memory into internal memory	4D-8
Save	Saving files form internal memory to mass memory	4D-10
GPIB	Transferring waveform data directly	4D-12
Auto Load	Auto loading	4D-15

LOAD Menu Display

Figure 4D-3 shows the general display for the **LOAD** menu. A description for each callout follows.

Top Screenshot: Catalog : Memory and NVRam

Mode: GPIB | Triggered mode | Stopped

Free : 2372KB

Name	Type	Size	Date & Time	Comment
CHIRP_S	WFM	17332	93-11-12 12:32	
D_EXP_P	WFM	20948	93-11-12 12:33	
EXP_P	WFM	9140	93-11-12 12:33	
GAUSS_P	WFM	9140	93-11-12 12:33	
LORENT_P	WFM	9140	93-11-12 12:33	
M_DISK_W	WFM	1348	93-11-12 12:34	
P_MOD_S	WFM	2996	93-11-12 12:34	
SINX_X_P	WFM	32948	93-11-12 12:37	
SQU_SIN	WFM	9140	93-11-12 12:36	

Free : 13KB

Name	Type	Size	Date & Time	Comment
SAMPLE-1	WFM	2948	93-11-11 12:00	
SAMPLE-2	WFM	2948	93-11-11 12:03	
SAMPLE-3	WFM	2948	93-11-11 12:09	
SAMPLE-4	EQU	296	93-11-11 12:11	
SAMPLE-4	WFM	2948	93-11-11 12:10	
SAMPLE-5	SEQ	960	93-11-11 12:13	
SAMPLE-6	AST	554	93-11-11 12:15	

Device: NVRam | **Load** | Save | Auto Load: Off

Bottom Screenshot: Catalog : GPIB

Mode: GPIB | Triggered mode | Stopped

Free : 2372KB

Name	Type	Size	Date & Time	Comment
CHIRP_S	WFM	17332	93-11-12 12:32	
D_EXP_P	WFM	20948	93-11-12 12:33	
EXP_P	WFM	9140	93-11-12 12:33	
GAUSS_P	WFM	9140	93-11-12 12:33	
LORENT_P	WFM	9140	93-11-12 12:33	
M_DISK_W	WFM	1348	93-11-12 12:34	
P_MOD_S	WFM	2996	93-11-12 12:34	
SINX_X_P	WFM	32948	93-11-12 12:37	
SQU_SIN	WFM	9140	93-11-12 12:36	

Loaded as

Name	Loaded as
Tek TDS CH1	TDSCH1 WFM
Tek TDS CH2	TDSCH2 WFM
Tek TDS CH3	TDSCH3 WFM
Tek TDS CH4	TDSCH4 WFM
Tek TDS REF1	TDSREF1 WFM
Tek TDS REF2	TDSREF2 WFM
Tek TDS REF3	TDSREF3 WFM
Tek TDS REF4	TDSREF4 WFM
Tek 2400 CH1	2400CH1 WFM

Device: GPIB | **Load** | Auto Load: Off

Figure 4D-3: LOAD Menu CRT Screen Display

(1) Internal memory file list

This is a list of the files currently loaded into internal memory. The list shows the file names, the file types, file sizes (in bytes), the date and time the file was created, and a comment. The space remaining in internal memory, into which files can be loaded, is displayed in the upper right-hand corner of the list.

For the **LOAD** menu, when a file is loaded into internal memory from mass memory or from another instrument through the GPIB interface, that file is added to this list.

For the **SAVE** menu, you can select files to save from this list to mass memory.

(2) Mass memory file list

This list is displayed when mass memory has been selected for **Device**. It contains all files that have been saved to mass memory. The file data is the same as in (1), above.

For the **LOAD** menu, you can select files to load from this list to the AWG2041 internal memory.

For the **SAVE** menu, when a file is saved from internal memory of the instrument to mass memory, the saved file is added to this list.

(3) GPIB file list

This list is displayed when GPIB has been selected for **Device**. It shows all other instruments connected to this instrument through the GPIB interface. Waveform data can be sent to the internal memory of this instrument from the instruments shown in this list. When waveform files are loaded in this manner, a name appears in the "**Loaded as**" column.

Selecting the Device

Device

Use **Device** to select the source from which files are loaded into the AWG2041 internal memory and the destination to which files are saved from internal memory. You may select **Disk**, **NVRam** or **GPIB**.

Procedure

- Step 1:** Select **Device** from the bottom menu.
- Step 2:** Select **Disk**, **NVRam** or **GPIB** from the side menu.

The following items are listed in the side menu:



Disk – A floppy disk. Files are saved to or loaded from a floppy disk inserted into the floppy disk drive on the right side of the instrument.



NVRam – The instrument's internal non-volatile RAM.

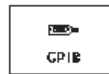

GPIB – The GPIB interface. Used to transfer waveform data directly from another instrument to this instrument through a GPIB cable.

To transfer waveform data through the GPIB interface, the remote port must be set to **GPIB** and the GPIB operating mode must be set to **Waveform Transfer**. If this is not done, the following message will appear when you select the **GPIB** item:

The GPIB configuration is not "Waveform Transfer" and the Remote Port is not "GPIB".

Are you sure of changing the parameters to match the transfer operation ?

Selecting **O.K.** in the sub-menu at this point will cause the remote port to be set to the **GPIB** interface and the GPIB operating mode to be set to **Waveform Transfer** automatically.

Table 4D-2 shows a list of instruments for which direct transfer of waveform data to this instrument is supported.

Table 4D-2: Supported Instruments

Manufacturer	Model
Tektronix	TDS Series Digital Storage Oscilloscope TDS300 Series, TDS400 Series, TDS500 [A] Series, TDS600 [A] Series
	2400 Series Digital Storage Oscilloscope 2430 [A], 2432, 2440
	2200 Series Digital Storage Oscilloscope 2212, 2221A, 2224, 2232
	11K Series Digital Storage Oscilloscope 11201 [A], 11401, 11402 [A], 11403 [A]
	DSA Series Digitizing Analyzer DSA601 [A], DSA602 [A]
	RTD720 Waveform Digitizer
	9500 Series First Data Cache 9503, 9504 (Use together with RTD710 [A])
Sony Tektronix	RTD710 Series Waveform Digitizer RTD710[A]
	AWG2000 Series Arbitrary Waveform Generator AWG2005, AWG2020,AWG2021, AWG2040, AWG2041
	AFG2020 Function Waveform Generator
Hewlett Packard	54600 Series Digital Storage Oscilloscope HP54501A, HP54502A, HP54503A, HP54504A, HP54510A
	54500 Series Digital Storage Oscilloscope HP54600A, HP54601A, HP54602A
LeCroy	94x0 Series Digital Storage Oscilloscope 9410, 9414, 9420, 9424, 9430, 9450
Yokogawa Electric	DL1000 Series Digital Storage Oscilloscope DL1100, DL1200 [E]

Loading Files from Mass Memory into Internal Memory

Load

If **Disk** or **NVRam** has been selected for **Device**, the **LOAD** menu appears when the **Load** item in the bottom menu is selected. See Figure 4D-4. The internal memory file list is displayed on the upper screen and the list of files saved onto mass memory is displayed on the lower screen.

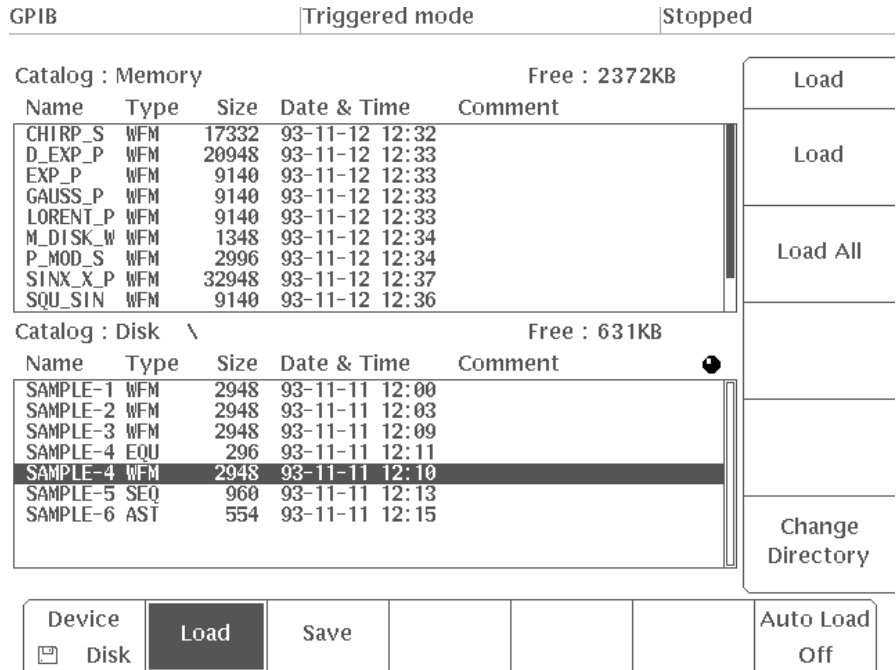

Figure 4D-4: LOAD Menu

Procedure

To Load files into internal memory from mass memory, perform these steps:

- Step 1:** Select **Device** from the bottom menu.
- Step 2:** Select **Disk** or **NVRam** from the side menu.

When the **Device** is **Disk**, the **Change Directory** item is displayed on the side menu. When this item is selected, the current directory can be changed. This item is the same as the **Change Directory** item on the **UTILITY** menu. See the explanation in "Using the Disk Menu" in Section 4E, "UTILITY Menu."

There is no directory hierarchy for the **NVRam**.

- Step 3:** Select **Load** from the bottom menu.

- Step 4:** Use the general purpose knob to select files to load into internal memory from the mass memory file list.
- Step 5:** Select **Load** from the side menu. The selected file is loaded into internal memory.

When **Load All** is selected from the side menu, all the files in the specified mass memory (for a disk, the current directory) are loaded into internal memory.

NOTE. When **Load** or **Load All** is executed, if there is already a file in internal memory with the same name as a file to be loaded, the system displays a message asking you whether or not to overwrite the file now in internal memory with the one being loaded. Answer **O.K.** or **Cancel**.

Loading Autostep Files

Some files created on other instruments in the AWG series other than the AWG2041 may have no data set for CH1. When loading an autostep file to the AWG2041 from disk, only the steps for which CH1 data has been set will be read in. When there is no data for CH1 on any of the steps, an attempt to load the file will cause the following message for confirmation to be displayed and the file will not be loaded:

" *.AST " has not CH1 data.**

Saving Files from Internal Memory to Mass Memory

Save

If **Disk** or **NVRam** has been selected for **Device**, the **Save** menu appears when the **Save** item is selected from the bottom menu. See Figure 4D-5. The same as for the **LOAD** menu, the internal memory file list is displayed on the upper screen. From this list, you select the file to be saved to mass memory.

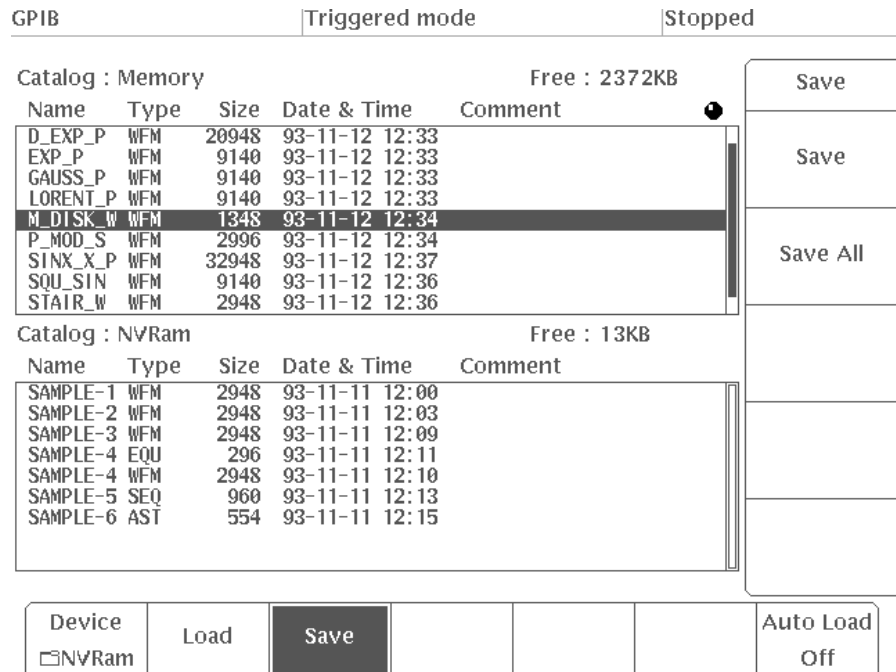

Figure 4D-5: SAVE Menu

Procedure

To Save files into mass memory from internal memory, perform these steps:

- Step 1:** Select **Device** from the bottom menu.
- Step 2:** Select **Disk** or **NVRam** from the side menu.

The same as for the **LOAD** menu, when the **Device** is **Disk**, **Change Directory** is displayed on the side menu and the current directory can be changed.

- Step 3:** Select **Save** from the bottom menu.
- Step 4:** Use the general purpose knob to select the file to be saved to mass memory from the internal memory file list.

- Step 5:** Select **Save** from the side menu. The selected file is saved to the specified mass memory (for a disk, the current directory).

When **Save All** is selected from the side menu, all the files in the internal memory are saved to the specified mass memory.

NOTE. When **Save** or **Save All** is executed, if there is already a file in the mass memory with the same name as a file to be saved, the system asks you if you want to replace the file now in mass memory with the one to be saved. Answer either **O.K.** or **Cancel**.

Save
as ASCII

Saving Data in Text Format

The **Save as ASCII** item appears in the side menu when an equation file (.EQU) has been selected from the list of files in internal memory and **Disk** has been selected for **Device**. Use this item to save the (binary format) data in the equation file in MS-DOS text format. Files saved in this manner are denoted by the extension **.EQA** after the file name. See page 4D-14 for further information on **.EQA** files.

The following items are written to the data of files saved in text format:

File Data	Description
# COMMENT: <comment>	The comment written to the selected equation file (.EQU), if any
# WAVEFORM POINTS= <point count>	The setting for number of waveform points (Waveform Points)
Calculation formula	

When comments and waveform point sizes are written to **.EQA** files as noted above, these are reflected in the equation files (.EQU) created when the **.EQA** files are loaded to this instrument.

Transferring Waveform Data Directly

GPIB

When **GPIB** has been selected for **Device**, waveform data can be transferred directly to this instrument from supported digital storage oscilloscopes, etc. through the GPIB interface. See Table 4D-2 for a list of supported instruments.

Loading Waveform Data

To load a waveform file directly to this instrument from one of the instruments for which direct transfer of waveform data is supported:

Procedure

- Step 1:** Using a GPIB cable, connect this instrument to the instrument from which waveform data is to be transferred, as shown in Figure 4D-6.

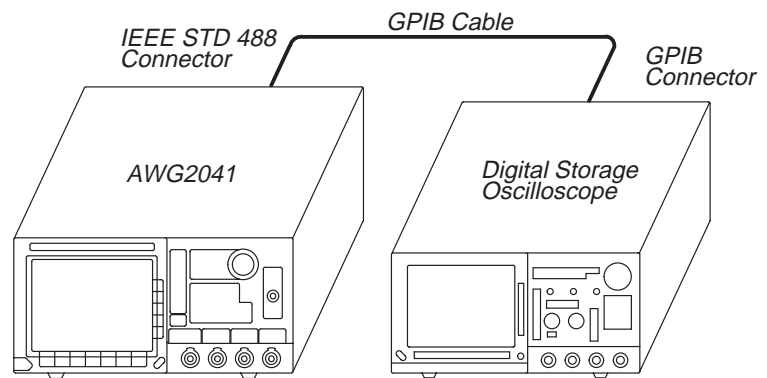

Figure 4D-6: Connecting Instruments

- Step 2:** Create the waveform to be transferred on the other (source) instrument.
- Step 3:** Select **Device** from the bottom menu.
- Step 4:** Select **GPIB** from the side menu.

A message will be displayed when Remote Port [**UTILITY (MENU)** → **Misc** (bottom menu) → **Config...** (side menu) → **Remote Port** (sub-menu)] is set to **RS232C** or when GPIB [**UTILITY (MENU)** → **GPIB** (bottom menu)] is set to anything other than **Waveform Transfer**. Pressing **O.K.** in response to this message will cause these settings to be automatically changed to **GPIB** and **Waveform Transfer**, respectively, and the instrument will be ready for direct waveform transfer through the **GPIB** interface.

- Step 5:** Select **Load** from the bottom menu.
- Step 6:** Using the general purpose knob, select the channel and the name of the instrument from which the data will be transferred from the "**Name**" column in the **GPIB Source** list at the bottom of the screen. When waveform data is loaded into the internal memory of the AWG2041, a waveform file will be created with the name shown in the "**Loaded as**" column. Figure 4D-7 shows the GPIB Source list.

Catalog : GPIB Source

Name	Loaded as	
Tek TDS CH1	TDSCH1	WFM
Tek TDS CH2	TDSCH2	WFM
Tek TDS CH3	TDSCH3	WFM
Tek TDS CH4	TDSCH4	WFM
Tek TDS REF1	TDSREF1	WFM
Tek TDS REF2	TDSREF2	WFM
Tek TDS REF3	TDSREF3	WFM
Tek TDS REF4	TDSREF4	WFM
Tek 2400 CH1	2400CH1	WFM

Figure 4D-7: GPIB Source List

- Step 7:** Choose **Select Source Address** from the side menu and, using the general purpose knob, select the GPIB address for the instrument from which data is to be loaded.
- Step 8:** Select **Load** from the side menu. Data transfer will begin and the transferred file will be added to the list of files stored in internal memory at the top of the screen, under the name shown in the "**Loaded as**" column.

Data transfers can include not only waveform data but output settings such as clock frequency and amplitude as well. When the clock frequency and amplitude exceed the allowable setting range in the **SETUP** menu, these values will be replaced with the nearest allowable value (in other words, the maximum or minimum value).

Load
without
Preamble

When **Load Without Preamble** from the side menu is selected, waveform data is loaded by itself, i.e. without output settings. In such cases, the output parameters are set to their default values.

Selecting Instruments Made by Other Manufacturers

The following procedure is used to select digital storage oscilloscopes made by other manufacturers. The procedure up to Step 5 is the same as that for loading waveform data.

Procedure

- Step 6:** Using the general purpose knob, select **Others...** from the **GPIB Source** list.
- Step 7:** Press the **Load** button in the side menu. A list of models will appear.

Catalog : GPIB Source

Name	Loaded as
54600 CH1	54600CH1 WFM
54600 CH2	54600CH2 WFM
54600 CH3	54600CH3 WFM
54600 CH4	54600CH4 WFM
54500 CH1	54500CH1 WFM
54500 CH2	54500CH2 WFM
54500 MEM1	54500M1 WFM
54500 MEM2	54500M2 WFM
Others...	

Figure 4D-8: List of Supported Models Made by Other Manufacturers

NOTE. Contact a Tektronix sales office in the event that waveform transfer is not possible from an instrument made by another manufacturer, due to an upgrade or other change.

- Step 8:** Using the general purpose knob, select the instrument in the list from which data will be loaded.
- Step 9:** Choose **Select Source Address** from the side menu and then use the general purpose knob to select the GPIB address for the instrument from which files will be loaded.
- Step 10:** Select **Load** from the side menu. Data transfer will be performed and the waveform file will be added to the list of files stored in internal memory at the top of the screen, under the name shown in the **"Loaded as"** column.

Auto Loading



Use the side menu of the **Auto Load** to automatically load files from the mass memory into the internal memory when the instrument is switched on.

Procedure

- Step 1:** Select **Auto Load** from the bottom menu.
- Step 2:** Select an item from the side menu.



From Disk – When this instrument is switched on, files are loaded automatically from the floppy disk to the internal memory of the instrument. In this case, all the files in the **AWG2041** directory are loaded. If there is no **AWG2041** directory, no auto load is carried out. This directory can be created with Disk on the **UTILITY** menu. For details, see the explanation in "Using the Disk Menu" in Section 4E "UTILITY Menu."



From NVRam – When this instrument is switched on, all the files in the non-volatile memory are loaded automatically into the internal memory.

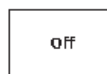

Off – Switches off auto loading.

When **from Disk** or **from NVRam** is selected from the side menu, advance the procedure below.

- Step 3:** Switch the AWG2041 power off, then on again. Select the **LOAD/SAVE** menu on the front panel to check that files are automatically loaded from mass memory to internal memory.

Supported Floppy Disk Files

Table 4D-3 shows a list of file name extensions denoting the type of disk files that can be loaded to the internal memory of the AWG2041.

Table 4D-3: Supported Floppy Disk Files

Extension	Description	Result of Load Operation
.ISF	Waveform data files saved in ISF format (Instrument Specific Format) using the waveform save function in the S34TDS1 Data Manager software	.ISF, .WVN, .WFB and .WFM files are automatically converted into .WFM files in the AWG2041 instrument's internal format and then stored in internal memory. When this is done, except for the .WFM file, the name of the file is retained as is, with only the extension changed to .WFM. In the .WFM file, file name and extension are as it is.
.WVN	Waveform data files saved using the waveform save function in the S37UT01 Utility software.	
.WFB	Waveform data files saved in binary format on a DSA600A series instrument	
.WFM	Waveform data files created in a TDS series instrument.	
.EQA	Equation files in MS-DOS text format created in a PC editor, etc.	.EQA files are automatically converted into .EQU files in the AWG2041 instrument's internal format and then stored in internal memory. When this is done, the name of the file is retained as is, with only the extension changed to .EQU. When the following items are written to the .EQA file, these items are reflected in the .EQU file. # COMMENT: <comment> # WAVEFORM POINTS = <point count>

All of these files are displayed in the Catalog menu screens for **Disk** in the **UTILITY** menu and **Device Disk** in the **LOAD/SAVE** menu, the same as files with other extensions. The extension for each file is shown in the **Type** column.

NOTE. As with other files on the instrument, the **Rename, Delete, Delete All, Lock** and other operations can be performed for these files, and they are also subject to the **Load All** and **Auto Load** operations in the **LOAD** menu.

If unexpected file formats or file contents are encountered when loading .ISF, .WVN, .WFB or .EQA files, an error usually results and "Invalid file format" or a similar message is displayed.

UTILITY Menu

General Description

Press the **MENU** column **UTILITY** button to display the **UTILITY** menu. The bottom menu contains the **Disk**, **NVRam**, **GPIB**, **RS232C**, **Date Time**, **Misc**, and **Diag/Cal** items. Use these items to do the following:

Disk

- Disk format
- Editing files saved onto disks
- Disk directory creation and current directory change

NVRam

- Editing files saved onto internal nonvolatile memory (NVRam)

GPIB

- Setting GPIB Configuration
See Programmer manual for details.

RS232C

- Setting RS-232C parameters
See Programmer manual for details.

Date Time

- Setting the Date and Time

Misc

- Setting the Display Brightness
- Setting the Order of Files
- Date/Time Display
- Factory Settings
- Deleting Data From Memory
- Remote Port Settings
- Settings for Hard Copy Output
- Setting the Hardware Sequencer
- System and GPIB/RS-232-C Status
- I/O Event Reporting
See Programmer Manual for details.

Diag/Cal

- Diagnostics and Calibration

UTILITY Menu Structure

Figure 4E-1 shows the configuration of the **UTILITY** menu.

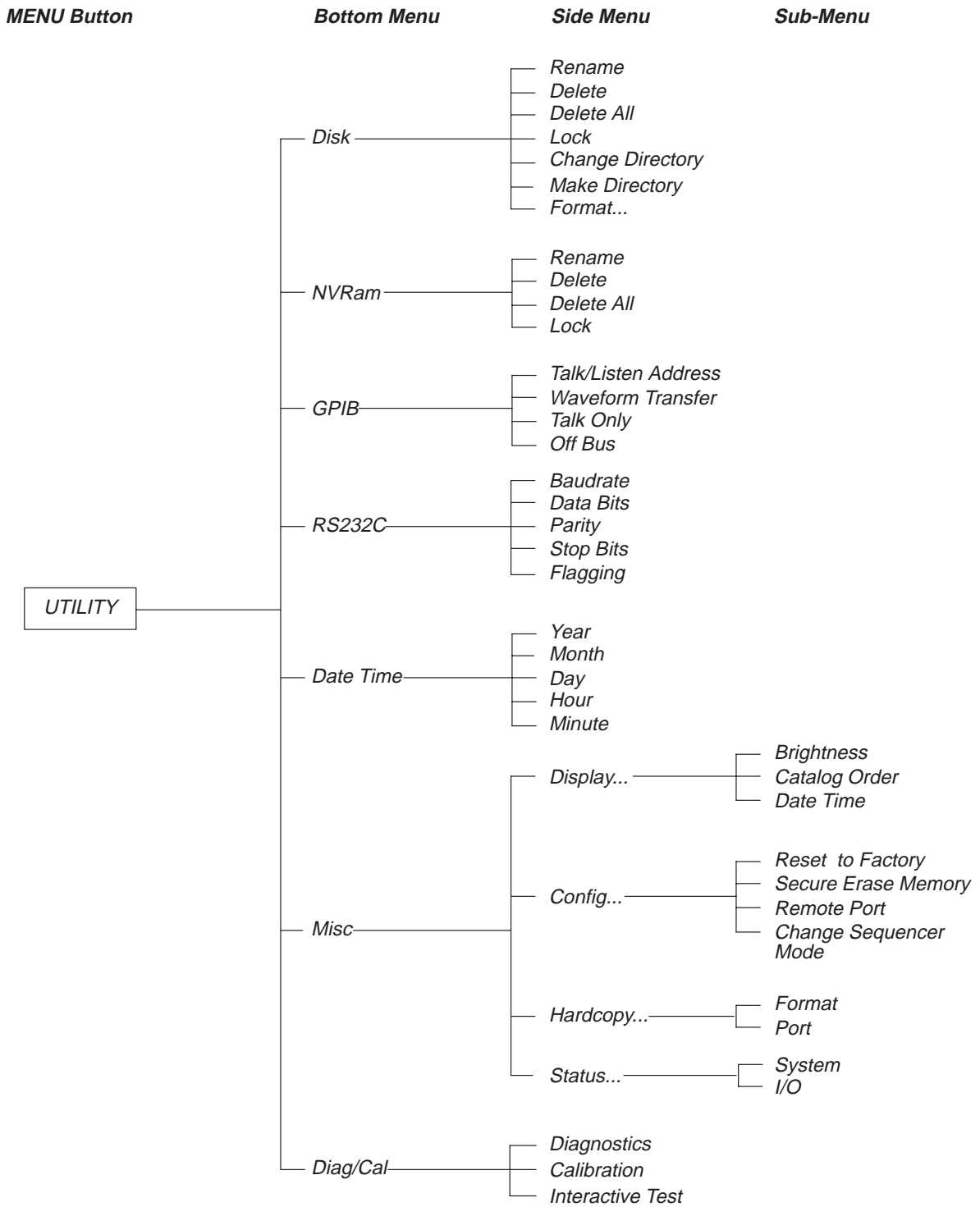

Figure 4E-1: UTILITY Menu Structure

Menu Functions

The following table describes the function of each of the menu items and gives the number of the page on which you can find a more detailed explanation of that item.

Table 4E-1: Menu Functions

Menu	Function	Page
Disk	Using the disk menu	4E-4
Rename	Renaming a file	4A-8,4E-12
Delete	Deleting a file	4A-9,4E-12
Delete All	Deleting all files	4A-9,4E-12
Lock	Locking and unlocking a file	4A-11,4E-12
Change Directory	Changing directories	4E-8
Make Directory	Creating directories	4E-8
Format...	Floppy disk format	4E-4
NVRam	Internal non-volatile memory	4E-12
GPIB	GPIB configuration	4E-13
Talk/Listen Address Waveform Transfer Talk Only Off Bus	Setting the operating mode	4E-14
RS232C	RS-232-C parameters	4E-15
Baudrate	Setting the baud rate	4E-16
Data Bits	Setting the number of data bits	
Parity	Setting the parity	
Stop Bits	Setting the number of stop bits	
Flagging	Setting flags	
Date Time	Setting the date and time	4E-17
Misc	Other settings and displays	4E-18
Display...	Setting the display	4E-18
Brightness	Setting the display brightness	4E-19
Catalog Order	Setting the order of files	4E-19
Date Time	Date/Time display	4E-22
Config...	Configuration	4E-23
Reset to Factory	Factory settings	4E-23
Secure Erase Memory	Deleting data from memory	4E-23
Remote Port	Remote Port Settings	4E-24
Change Sequencer Mode	Setting the hardware sequencer	4E-25
Hardcopy...	Settings for hard copy output	4E-26
Format	Selecting the format	4E-26
Port	Selecting the port	4E-27
Status...	Status display	4E-29
System	System and GPIB/RS-232-C status	4E-29
I/O	I/O event reporting	4E-30

Table 4E-1: Menu Functions (Cont)

Menu	Function	Page
Diag/Cal	Diagnostics and calibration	4E-31
Diagnostics	Diagnostics	4E-31
Calibrations	Calibration	4E-32
Interactive Test	Pattern display (for instrument adjustment)	4E-33

Disk and Nonvolatile Memory

Save the files created with the Editor onto internal nonvolatile memory and/or 3.5-inch floppy disks.



Using the Disk Menu

This item can format disks, make directories on disks, change the current directory, edit files saved to disk, etc.

Insert the 3.5-inch floppy disk into this instrument's floppy disk drive, then select **Disk** from the bottom menu. The files saved in the root directory and AWG2041 directory are read out and displayed on the CRT screen. When **Disk** is selected in the bottom menu, the following items will appear in the side menu:

- **Rename**
- **Delete**
- **Delete All**
- **Lock**
- **Change Directory**
- **Make Directory**
- **Format...**

The side menu is made up of 2 pages. Select **More** to display the second page of the side menu.

Floppy Disk Format

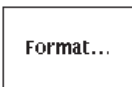

This instrument can format 2DD (double density) and 2HD (high density) disks in three different MS-DOS formats: IBM-PC format, NEC PC9800 series format, and Toshiba J3100 series format. Formatted disks are automatically labeled "**AWG2041**".

New floppy disks must be formatted before they can be used. Figure 4E-2 shows the new sub-menu displayed after formatting the disk.

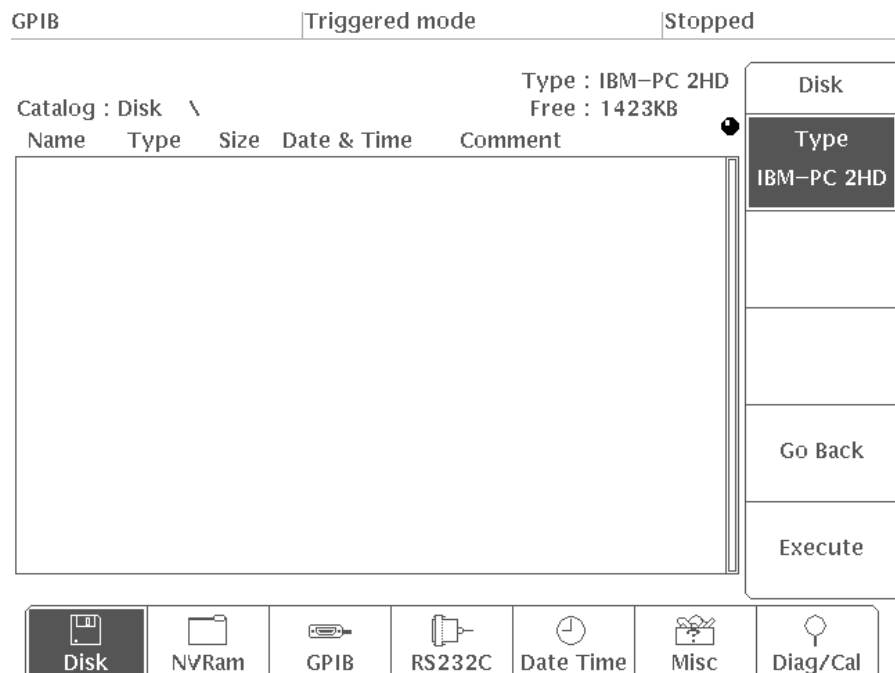

Figure 4E-2: Format... Sub-Menu Display

Formatting disks

To format floppy disks, perform these steps:

- Step 1:** Select **Disk** from the bottom menu.
- Step 2:** Insert the 3.5-inch floppy disk to be formatted into the disk drive on the right side panel of this instrument.

NOTE. Formatting a disk destroys any data on that disk! Before formatting a disk, make sure it contains no data you might ever need.

- Step 3:** Select **Format...** from the second page of the side menu.
- Step 4:** The currently selected format will appear in the **Type** item in the sub-menu. Select the correct format with the general purpose knob. The following formats can be selected for **Type**:
 - **IBM-PC 2HD**
 - **PC9800 2HD**
 - **J3100 2HD**
 - **IBM-PC 2DD**
 - **PC9800 2DD**

When floppy disks written by this instrument are used in a personal computer, select the correct format type as indicated by Table 4E-2.

Table 4E-2: MS-DOS Formats for 3.5-inch Disks

Format Type	IBM-PC	PC9800	J3100
1.44 Mbytes/18 sectors (2HD)	1	3	2
1.2 Mbytes/8 sectors (2HD)	3	1	2
1.2 Mbytes/15 sectors (2HD)	3	2	1
720 Kbytes/9 sectors (2DD)	1	2	1
640 Kbytes/8 sectors (2DD)	2	1	2

- 1 : Format normally used on personal computer (format selected with AWG2041).
- 2 : Not regular format, but can be read and written.
- 3 : Can not be read or written.

NOTE. The IBM-PC and J3100 2DD formats are the same. Thus, use the **IBM-PC 2DD** format for **J3100 2DD** disks.

- Step 5:** After selecting the format, select **Execute** from the sub-menu. This starts the disk formatting. During formatting, a message to that effect, "**Formatting disk...**" is displayed on the screen.

NOTE. A disk with its write prevent tab in the write-protected position cannot be formatted. Slide the tab to the write-enable position, then try again. See the discussion below of write prevention.

When formatting is complete, the message on the screen will disappear and an empty file list will appear with the format type and available disk space shown in the upper right-hand corner.

- Step 6:** Select **Go Back** from the sub-menu. The system returns from the **Format...** current sub-menu to the previous side menu.
- Step 7:** Pressing the eject button on the right side of the disk drive ejects the floppy disk.

Handling Floppy Disks

To prevent disks from being damaged and to ensure the integrity of the data stored on them, you should be careful of the following:

- Do not place disks near a strong magnetic field or near a ferromagnetic substance that may cause them to be magnetized, as this will corrupt the data stored on the disk and result in errors.
- Do not expose disks to direct sunlight or high temperatures for long periods of time. Also, avoid storing them in places subject to extreme cold or high humidity. When bringing disks into a room from outside, do not use them immediately; let them become acclimated to the environment before use.
- Do not touch the recording medium on the surface of the disk. Fingerprints on the surface of the disk may cause the heads to skip, resulting in errors.
- When storing disks for long periods of time, be sure to place them in their protective cases.
- Be sure to place labels in the proper location on the disks.
- Do not press the eject button on the disk drive to eject the floppy disk while the indicator light is lit. This may cause the data stored on the disk to become corrupted, resulting in errors.

Protecting Disks From Accidental Erasure

There is a write protect tab on the underside of the floppy disk. To lock the disk, press this tab down toward the edge of the disk to expose the little hole underneath, as shown in Figure 4E-3. Locking the disk will prevent it from being written to or erased. To unlock the disk and enable it to be written to or erased, move the tab back toward the center of the disk so it covers the hole.

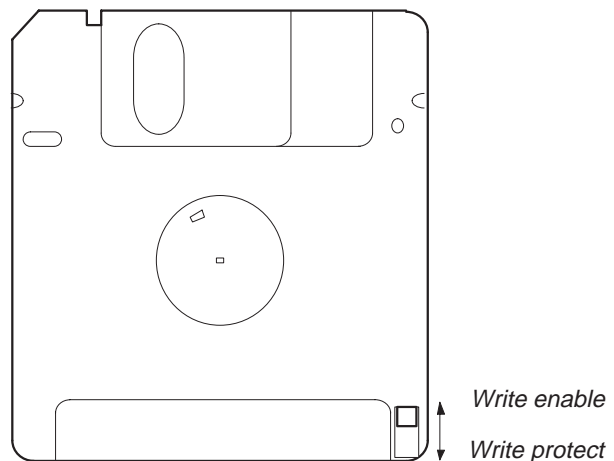

Figure 4E-3: Write Protect Tab on a Floppy Disk

Creating and Changing Directories

When there are many files, it becomes difficult to manage them. Placing the files of the same type into one single directory makes it easier to manage the files.

In addition to files, directories can also contain sub-directories. With directories, hierarchical structures can be constructed with successive directories. Directories are distinguished by their names. The original directory that contains all the files and directories is called the root directory and the directories within it are called sub-directories.

Make
Directory

Change
Directory

This instrument can make directories to manage files the same as with MS-DOS. Directories are created with the **Make Directory** side menu item. The suffix ".DIR" is attached to created directories.

To operate on a certain file within a given sub-directory, it is necessary to move to that sub-directory. Thus, use the **Change Directory** side menu item to move to the desired sub-directory. The next directory is now the object of any future operations and is called the current directory. The **LOAD/SAVE** menu can be used to change directories too.

The setting of the **LOAD/SAVE** menu **Auto Load** item determines the current directory at power on. When the Auto Load item is set to **Disk**, the directory **AWG2041** is automatically selected. (In this case, this **AWG2041** sub-directory must exist.) If **Auto Load** is **Off**, the root directory is selected.

NOTE. A file hierarchy with multiple layers can be created on the disk, using up to 54 characters, including the \ character. The shorter the directory name is, the deeper the levels that you can create. When the directory display becomes too large for the display area window, the initial section is omitted.

Example: Creating a Directory

For example, to create a sub-directory called AWG2041, such as root directory: AWG2041 (DIR) - perform the following steps.

Root directory ——— AWG2041 (DIR)

If the **AWG2041** directory has been created ahead of time, when its power is switched on, the files under the **AWG2041** directory are automatically loaded into internal memory by the **LOAD/SAVE** menu **Auto Load** setting.

The following procedure assumes that the current directory is the root directory. If the current directory is not the root directory, use **Change Directory** to change the current directory to the root directory. (See the Step 5 and the following steps.)

- Step 1:** Select **Disk** from the bottom menu.

A list of the files and directories in the root directory of the inserted floppy disk is displayed on the screen. See Figure 4E-4. **Catalog:Disk ** on the CRT screen shows that the current directory is the root directory.







GPIB	Triggered mode	Stopped																																																																																					
Catalog : Disk \		Type : IBM-PC 2HD Free : 1232KB																																																																																					
<table border="1" style="width: 100%; border-collapse: collapse;"> <thead> <tr> <th style="text-align: left;">Name</th> <th style="text-align: left;">Type</th> <th style="text-align: left;">Size</th> <th style="text-align: left;">Date & Time</th> <th style="text-align: left;">Comment</th> </tr> </thead> <tbody> <tr><td>AM_MOD</td><td>WFM</td><td>65638</td><td>93-11-10 10:52</td><td></td></tr> <tr><td>ATS</td><td>DIR</td><td>---</td><td>93-11-10 11:04</td><td></td></tr> <tr><td>A_RLC</td><td>WFM</td><td>16294</td><td>93-11-10 10:52</td><td></td></tr> <tr><td>CHIRP_S</td><td>WFM</td><td>16486</td><td>93-11-10 10:53</td><td></td></tr> <tr><td>D_EXP_P</td><td>WFM</td><td>20102</td><td>93-11-10 10:53</td><td></td></tr> <tr><td>EQUATION</td><td>DIR</td><td>---</td><td>93-11-10 11:01</td><td></td></tr> <tr><td>EXP_P</td><td>WFM</td><td>8294</td><td>93-11-10 10:54</td><td></td></tr> <tr><td>FUNCTION</td><td>DIR</td><td>---</td><td>93-11-10 11:00</td><td></td></tr> <tr><td>LORENT_P</td><td>WFM</td><td>8294</td><td>93-11-10 10:54</td><td></td></tr> <tr><td>M_DISK_W</td><td>WFM</td><td>502</td><td>93-11-10 10:55</td><td></td></tr> <tr><td>P_MOD_S</td><td>WFM</td><td>2150</td><td>93-11-10 10:55</td><td></td></tr> <tr><td>SINX_X_P</td><td>WFM</td><td>32102</td><td>93-11-10 10:55</td><td></td></tr> <tr><td>SQU_SIN</td><td>WFM</td><td>8294</td><td>93-11-10 10:56</td><td></td></tr> <tr><td>STAIR_W</td><td>WFM</td><td>2102</td><td>93-11-10 10:56</td><td></td></tr> <tr><td>TRAN_VOL</td><td>WFM</td><td>8294</td><td>93-11-10 10:56</td><td></td></tr> </tbody> </table>	Name	Type	Size	Date & Time	Comment	AM_MOD	WFM	65638	93-11-10 10:52		ATS	DIR	---	93-11-10 11:04		A_RLC	WFM	16294	93-11-10 10:52		CHIRP_S	WFM	16486	93-11-10 10:53		D_EXP_P	WFM	20102	93-11-10 10:53		EQUATION	DIR	---	93-11-10 11:01		EXP_P	WFM	8294	93-11-10 10:54		FUNCTION	DIR	---	93-11-10 11:00		LORENT_P	WFM	8294	93-11-10 10:54		M_DISK_W	WFM	502	93-11-10 10:55		P_MOD_S	WFM	2150	93-11-10 10:55		SINX_X_P	WFM	32102	93-11-10 10:55		SQU_SIN	WFM	8294	93-11-10 10:56		STAIR_W	WFM	2102	93-11-10 10:56		TRAN_VOL	WFM	8294	93-11-10 10:56		<table border="1" style="width: 100%; border-collapse: collapse;"> <tr><td style="text-align: center;">Disk</td></tr> <tr><td style="text-align: center;">Rename</td></tr> <tr><td style="text-align: center;">Delete</td></tr> <tr><td style="text-align: center;">Delete All</td></tr> <tr><td style="text-align: center;">Lock On Off</td></tr> <tr><td style="text-align: center;">More 1 of 2</td></tr> </table>	Disk	Rename	Delete	Delete All	Lock On Off	More 1 of 2
Name	Type	Size	Date & Time	Comment																																																																																			
AM_MOD	WFM	65638	93-11-10 10:52																																																																																				
ATS	DIR	---	93-11-10 11:04																																																																																				
A_RLC	WFM	16294	93-11-10 10:52																																																																																				
CHIRP_S	WFM	16486	93-11-10 10:53																																																																																				
D_EXP_P	WFM	20102	93-11-10 10:53																																																																																				
EQUATION	DIR	---	93-11-10 11:01																																																																																				
EXP_P	WFM	8294	93-11-10 10:54																																																																																				
FUNCTION	DIR	---	93-11-10 11:00																																																																																				
LORENT_P	WFM	8294	93-11-10 10:54																																																																																				
M_DISK_W	WFM	502	93-11-10 10:55																																																																																				
P_MOD_S	WFM	2150	93-11-10 10:55																																																																																				
SINX_X_P	WFM	32102	93-11-10 10:55																																																																																				
SQU_SIN	WFM	8294	93-11-10 10:56																																																																																				
STAIR_W	WFM	2102	93-11-10 10:56																																																																																				
TRAN_VOL	WFM	8294	93-11-10 10:56																																																																																				
Disk																																																																																							
Rename																																																																																							
Delete																																																																																							
Delete All																																																																																							
Lock On Off																																																																																							
More 1 of 2																																																																																							
 Disk	 NVRam	 GPIB	 RS232C	 Date Time	 Misc	 Diag/Cal																																																																																	

Figure 4E-4: File and Directory Display in the Root Directory

- Step 2:** Select **More 1 of 2**, then **Make Directory** from the side menu. The menu for naming the directory is displayed.

- Step 3:** Use the general purpose knob to input a directory name of **AWG2041**. See Figure 4E-5.

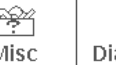
The method for inputting the directory name is the same as the method for inputting a file name in the waveform editor. See "Naming a File" in the discussion of the waveform editor.

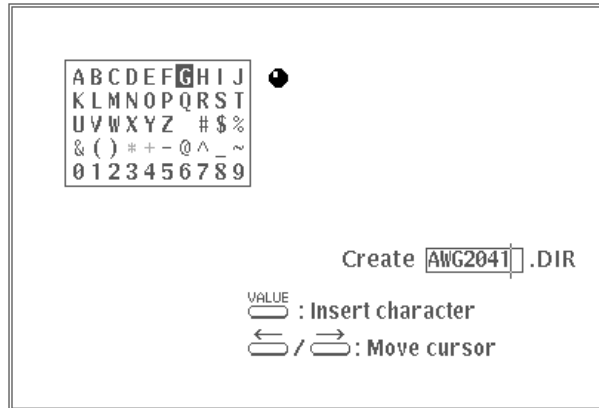

Figure 4E-5: Directory Name Input

- Step 4:** After you have input the directory name, select **O.K.** from the sub-menu. The **AWG2041** directory is created in the floppy disk.

Example: Changing a Directory

- Step 5:** Select **Change Directory** from the side menu.
- Step 6:** Use the general purpose knob to select the **AWG2041** sub-directory you just created from the directory list. See Figure 4E-6.

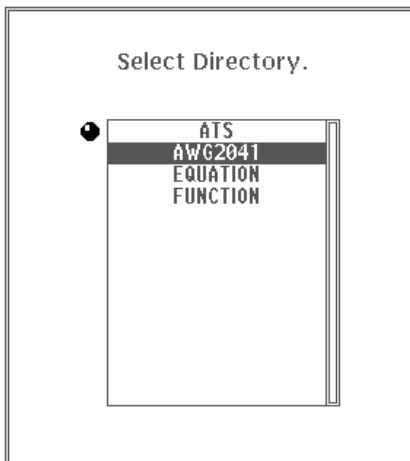

Figure 4E-6: Directory Displayed When Change Directory is Selected

- Step 7:** Select **O.K.** from the sub-menu. The current directory changes to the **AWG2041** directory you just made and the directory display becomes **Catalog:Disk\AWG2041**. At this time, the **AWG2041** directory is empty. See Figure 4E-7.

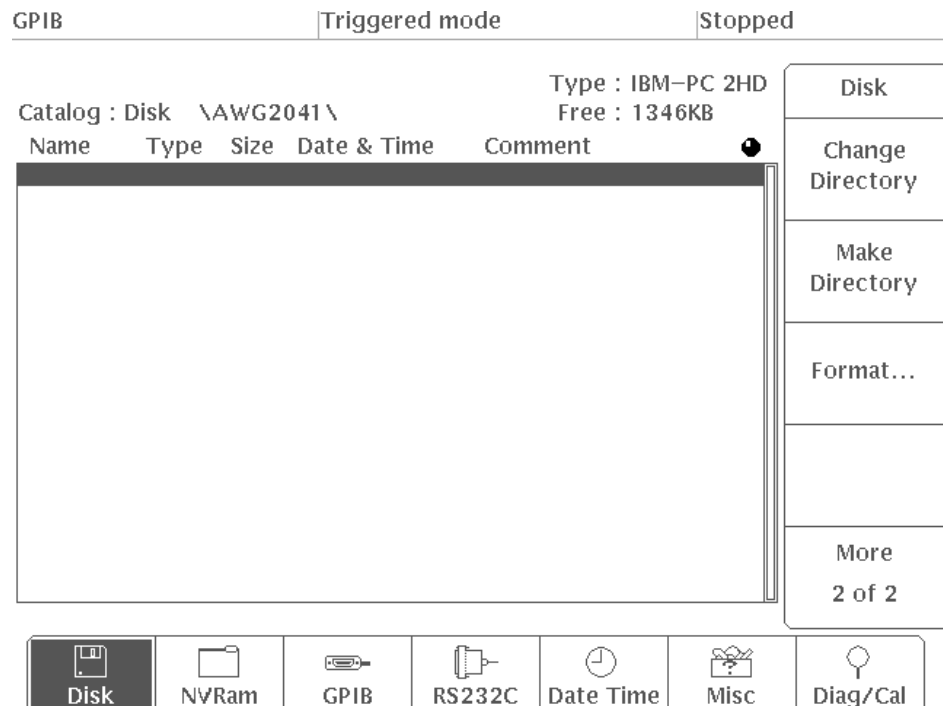
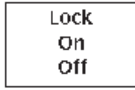
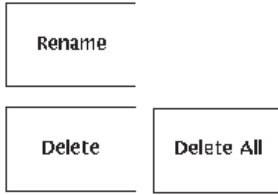

Figure 4E-7: File List for a Newly Created Directory

This completes the move of the current directory to the **AWG2041** sub-directory. Files and new directories can be created in this directory. Next, here is how to return the current directory to the root directory.

- Step 8:** Again, select **Change Directory** from the side menu. Only **..** is displayed in the directory list. Select **O.K.** from the sub-menu.

Selecting **..** from the directory list moves the current directory to the directory one above. In this case, that is the root directory, so the system is back where it started.



Operating Files Saved to Disk

The side menu has **Rename**, **Delete**, and **Delete All** for file operating. These items are the same as those in the **EDIT** menu. See Page 4A-8 to 4A-11. These functions can rename and delete files. Directories can also be deleted by selecting the **Delete** item. However, this is only possible when there are no files and directories at levels below the directory to be deleted.

Locking and Unlocking a File

This item locks a file. When a file is locked, the file can neither be changed nor erased. This item locks and unlocks a file the same as the **Lock** item in the **EDIT** menu. See Page 4A-11.

Internal Non-volatile Memory

Files saved to the internal non-volatile memory can be operated with this bottom menu. When **NVRam** is selected from the bottom menu, the **Rename**, **Delete**, **Delete All**, and **Lock** side menu items are displayed. These functions can rename, delete, and lock files. These items are the same as those in the **EDIT** menu. See Page 4A-8 to 4A-11.

Figure 4E-8 shows the menu displayed when **NVRam** is selected from the bottom menu.

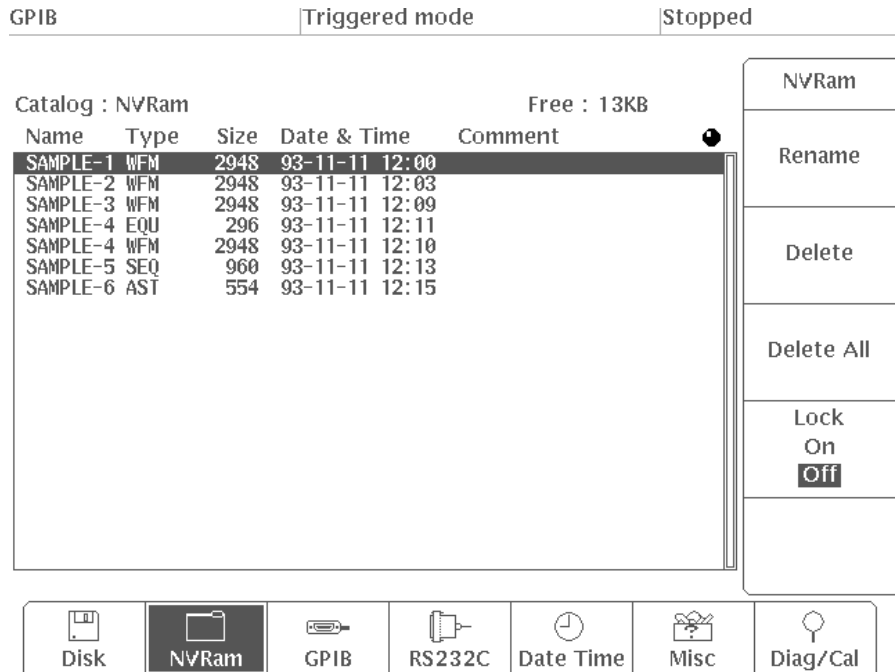

Figure 4E-8: Menu Displayed When NVRam is Selected

Remote Interface

This instrument's rear panel has two remote control interface ports: **IEEE STD 488 (GPIB)** and **RS-232-C**. A computer can be used to control the instrument remotely through these interfaces.

The port is selected using the **Remote Port** item [UTILITY menu → Misc (bottom menu) → Config... (side menu) → Remote Port].

GPIB

These are simple descriptions of the GPIB connection and GPIB configuration setting. For further details, see the Programmer Manual.

GPIB Connection

The cable from the GPIB controller (computer) is connected to the **IEEE STD 488** connector on this instrument's rear panel.

Setting GPIB Configuration

Devices on the GPIB bus must be configured compatibly in order to communicate.

Select **GPIB** from the bottom menu to set the GPIB configuration. See Figure 4E-9.

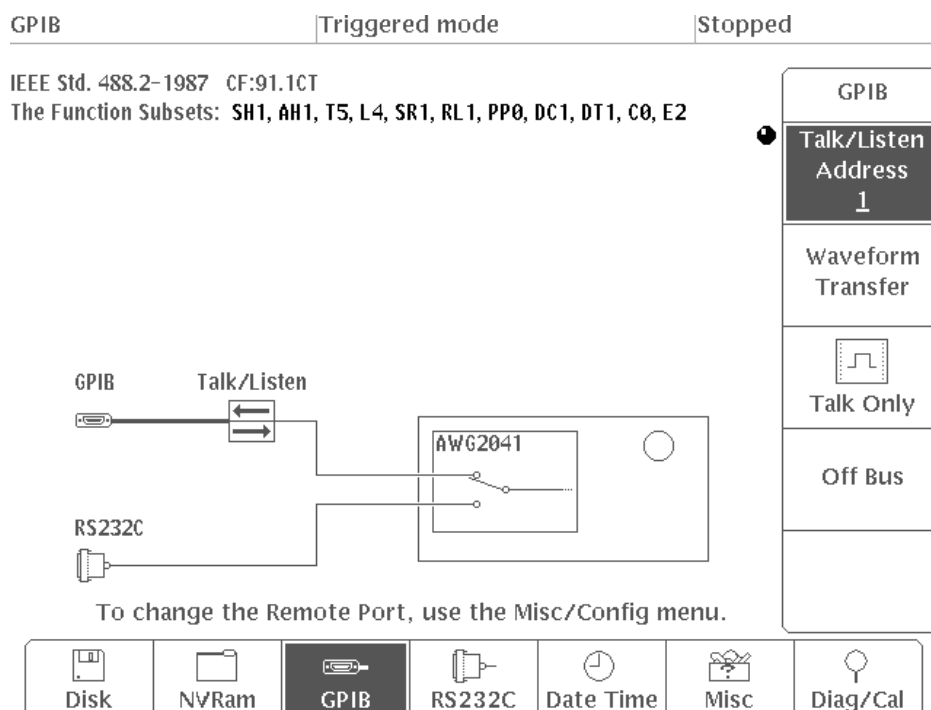

Figure 4E-9: Menu Displayed When GPIB is Selected

Use the side menu items to set the GPIB configuration and the address of this instrument.

This instrument can be set to one of four operating modes: talk/listen, waveform transfer, talk only, or off-bus. However, you should be aware that talk only and waveform transfer modes are not compliant with IEEE 488.2-1987.



Talk/Listen

Select talk/listen mode to communicate with the controller via the GPIB. When the **Talk/Listen Address** item is selected, the operating mode for this instrument and other devices is set to talk/listen and also the general purpose knob and the numeric keys set the GPIB address for this instrument. The GPIB address setting range is **0-30**. Other devices on the bus cannot use the address number allocated to this instrument.

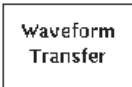

Waveform Transfer

Select **Waveform Transfer** mode to download waveform data. In this mode, waveform data does not go through the controller; it is downloaded directly to the internal memory of the instrument from a digital storage oscilloscope or other instrument. See Table 4D-2 in Section 4D **LOAD/SAVE** menu for a list of supported instruments.

Actual waveform transfer is performed using the **LOAD/SAVE** menu. See Page 4D-12.



Talk Only

Select **Talk Only** to output a hard copy of the waveform data. When the Port setting is **GPIB** [UTILITY menu → **Misc** (bottom menu) → **Hardcopy...** (side menu) → **Port** (sub-menu)], pressing the **HARDCOPY** button on the front panel causes a hard copy of the waveform to be output.



Off Bus

Select **Off Bus** to disconnect the AWG2041 from the GPIB bus.

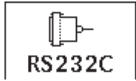

RS-232-C

Use the RS-232-C interface on the rear panel to allow remote control by a host computer. These are simple descriptions of the RS-232-C connection and RS-232-C parameter setting. For further details, see the AWG2041 Programmer Manual.

RS-232-C Connection

To select the RS-232-C port, select **RS232C** for **Remote Port** [UTILITY menu → **Misc** (bottom menu) → **Config...** (side menu) → **Remote Port** (sub-menu)].

A cable is connected between the computer and this instrument's RS-232-C connector. This instrument must be configured as the data communications equipment (DCE) and the host computer must be configured as the data terminal equipment (DTE).

Setting the RS-232-C Parameters

The RS-232-C parameters for both devices must match to allow communication between this instrument and the host computer.

Before communicating with the connected computer, the RS-232-C parameters are set with the menu in Figure 4E-10. Press the side button for the desired parameter and select it with the general purpose knob.

RS232C		Triggered mode			Stopped	
Baudrate	Data Bits	Parity	Stop Bits	Flagging	RS232C	
300 600 1200 2400 4800 9600 19200	7 8	None Even Odd	1 2	None Soft Hard	Baudrate 9600	
					Data Bits 8	
					Parity None	
					Stop Bits 1	
					Flagging None	

To change the Remote Port, use the Misc/Config menu.

Disk	NVRam	GPIB	RS232C	Date Time	Misc	Diag/Cal
------	-------	------	---------------	-----------	------	----------

Figure 4E-10: Menu Displayed When RS232C is Selected

UTILITY Menu

Baudrate

Baudrate – This item sets the transmission rate. The transmission rate of **300, 600, 1200, 2400, 4800, 9600,** and **19200** can be selected with the general purpose knob. Set this parameter to the same value as set on the computer.

Parity

Parity – This item sets the error detection method. The general purpose knob is used to select parity of **None, Odd,** or **Even.** Set this parameter to match the connected computer's parity.

Data Bits

Data Bits – This item selects **7** or **8** data bits. Set this parameter to match the connected computer's data bits.

Stop Bits

Stop Bits – This item selects **1** or **2** stop bits. Set this parameter to match the connected computer's stop bits.

Flagging

Flagging – This item selects **None, Soft,** or **Hard.** This item is used by this instrument or the computer to announce that the input buffer is full. Until the transmission allowed instruction is issued, the other device stops the data transfer.

Date and Time



When **Date Time** is selected from the bottom menu, a clock will appear on the screen, allowing you to set the date and time. The side menu will display items for **Year**, **Month**, **Day**, **Hour** and **Minute**. Pressing one of these items in the side menu will make it possible to set that clock parameter using the general purpose knob.

The set date and time are recorded as the time stamp when a file is created. Figure 4E-11 shows the menu displayed when **Date Time** is selected.

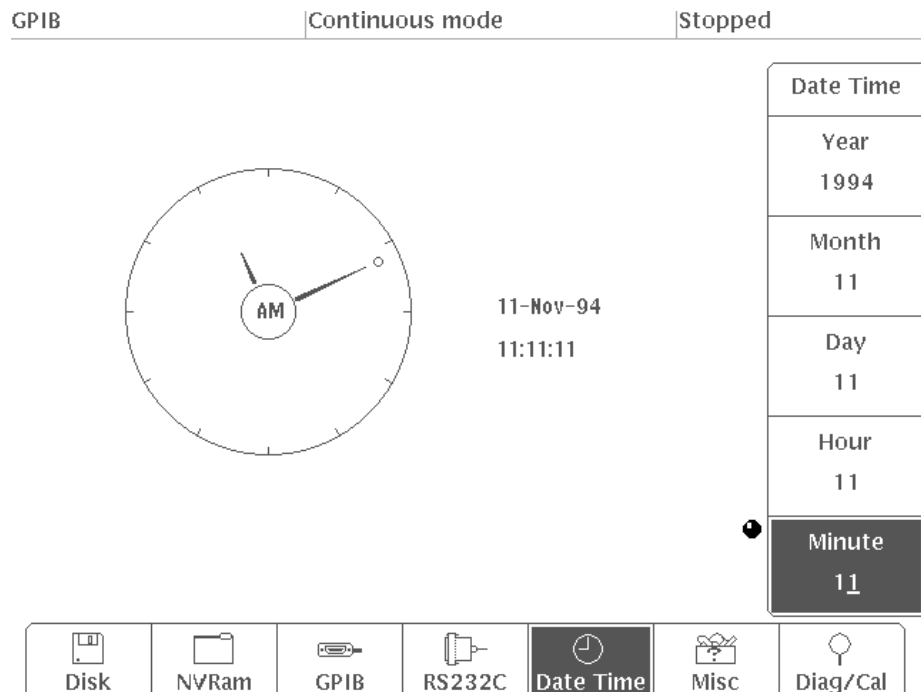

Figure 4E-11: Menu Displayed When Date Time is Selected

Setting the Date and Time

Procedure

- Step 1:** Select **Date Time** from the bottom menu.
- Step 2:** Select **Year** from the side menu. Use the general purpose knob or the numeric keys to set the year.
- Step 3:** In the same way, select the **Month**, **Day**, and **Hour** and set the month, day, and hour.
- Step 4:** Select **Minute** from the side menu. Each time the minute is set with the general purpose knob, the second is reset to **00**. When the time is set, the minute is set at the same time the second is reset to 0. (The second is also reset to **00** when the hour is set with **Hour**.)



Setting the Display Brightness

The AWG2041 screen has three levels of brightness. These levels are set with the **Brightness** item.

Procedure

To set the screen brightness:

- Step 1:** Select **Misc** from the bottom menu.
- Step 2:** Select **Display...** from the side menu.
- Step 3:** Select **Brightness** from the sub-menu.
- Step 4:** Use the numeric keys or general purpose knob to input the appropriate display brightness. The display brightness can be adjusted in steps of 1% in the range 0-100%. The default display brightness is 70%.



Figure 4E-12: Setting the Display Brightness

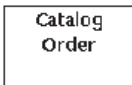

Setting the Order of Files

Use this item to set the order in which files are displayed in the catalog. You can display files sorted by file name, date and time or file type (extension). Figure 4E-13 shows the screen when **Catalog Order** has been chosen from the sub-menu.

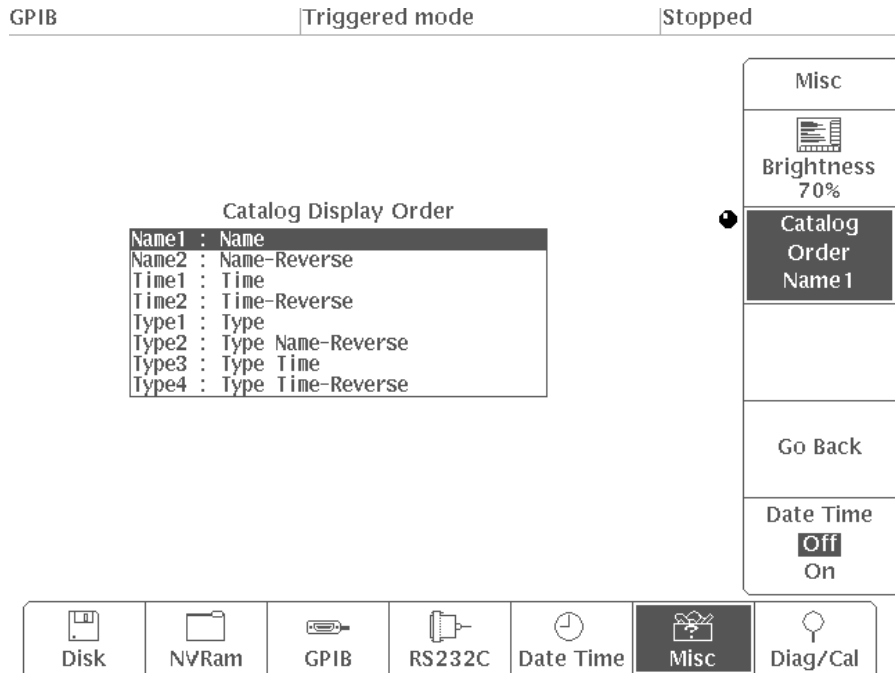

Figure 4E-13: Menu Displayed when Catalog Order is Selected

The files in the catalog are displayed in the initial **EDIT**, **LOAD/SAVE** and **UTILITY** menus. Changing the file order in a catalog will change the order in all menus. Figure 4E-14 shows the list of files as shown in the initial **EDIT** menu.

Catalog : Memory Free : 1955KB

Name	Type	Size	Date & Time	Comment
AM_MOD	EQU	686	93-11-10 10:52	
AM_MOD	WFM	66484	93-11-10 10:52	
A_RLC	EQU	686	93-11-10 10:52	
A_RLC	WFM	17140	93-11-10 10:52	
CHIRP_S	EQU	296	93-11-10 10:53	
CHIRP_S	WFM	17332	93-11-10 10:53	
D_EXP_P	EQU	530	93-11-10 10:53	
D_EXP_P	WFM	20948	93-11-10 10:53	
EXP_P	EQU	296	93-11-10 10:54	
EXP_P	WFM	9140	93-11-10 10:54	
LORENT_P	EQU	296	93-11-10 10:54	
LORENT_P	WFM	9140	93-11-10 10:54	
M_DISK_W	EQU	530	93-11-10 10:54	
M_DISK_W	WFM	1348	93-11-10 10:55	
P_MOD_S	EQU	4976	93-11-10 10:55	
P_MOD_S	WFM	2996	93-11-10 10:55	
SINX_X_P	EQU	452	93-11-10 10:55	
SINX_X_P	WFM	32948	93-11-10 10:55	
SQU_SIN	EQU	608	93-11-10 10:55	
SQU_SIN	WFM	9140	93-11-10 10:56	

Figure 4E-14: Catalog Files

Files in a catalog can be displayed by the following sorting conditions:

- **Name1: Name**
Files are displayed by file name (**Name**) in ASCII code order.
- **Name2: Name-Reverse**
Files are displayed by file name (**Name**) in reverse ASCII code order.
- **Time1: Time**
Files are displayed by creation date (**Date & Time**), from newest to oldest.
- **Time2: Time-Reverse**
Files are displayed by creation date (**Date & Time**), from oldest to newest.
- **Type1: Type**
Files are displayed by extension (**Type**) in alphabetical order.
- **Type2: Type Name-Reverse**
Files are displayed by extension (**Type**) in alphabetical order and, within each file type, by name (**Name**) in reverse ASCII code order.
- **Type3: Type Time**
Files are displayed by extension (**Type**) in alphabetical order and, within each file type, by creation date (**Date & Time**) from newest to oldest.
- **Type4: Type Time-Reverse**
Files are displayed by extension (**Type**) in alphabetical order and, within each file type, by creation date (**Date & Time**) from oldest to newest.

Procedure

To change the order in which files are displayed to Type4:

- Step 1:** Select **Misc** from the bottom menu.
- Step 2:** Select **Display...** from the side menu.
- Step 3:** Select **Catalog Order** from the sub-menu.
- Step 4:** Use the general purpose knob to select **Type4**.
- Step 5:** Press the **EDIT** button in the **MENU** column. Check to make sure that the files are sorted in the order you have selected.

Figure 4E-15 shows the files displayed in **Type4** format, with files sorted by extension (**Type**) in alphabetical order and within each file type by creation date (**Date & Time**), from oldest to newest.

Catalog : Memory Free : 1955KB

Name	Type	Size	Date & Time	Comment
AM_MOD	EQU	686	93-11-10 10:52	
A_RLC	EQU	686	93-11-10 10:52	
CHIRP_S	EQU	296	93-11-10 10:53	
D_EXP_P	EQU	530	93-11-10 10:53	
EXP_P	EQU	296	93-11-10 10:54	
LORENT_P	EQU	296	93-11-10 10:54	
M_DISK_W	EQU	530	93-11-10 10:54	
P_MOD_S	EQU	4976	93-11-10 10:55	
SINX_X_P	EQU	452	93-11-10 10:55	
SQU_SIN	EQU	608	93-11-10 10:55	
STAIR_W	EQU	2090	93-11-10 10:56	
TRAN_VOL	EQU	530	93-11-10 10:56	
AM_MOD	WFM	66484	93-11-10 10:52	
A_RLC	WFM	17140	93-11-10 10:52	
CHIRP_S	WFM	17332	93-11-10 10:53	
D_EXP_P	WFM	20948	93-11-10 10:53	
EXP_P	WFM	9140	93-11-10 10:54	
LORENT_P	WFM	9140	93-11-10 10:54	
M_DISK_W	WFM	1348	93-11-10 10:55	
P_MOD_S	WFM	2996	93-11-10 10:55	

Figure 4E-15: Catalog With Files Displayed in Type4 Format

Date/Time Display



Use this item to display the date and time.

- Step 1:** Select **Misc** from the bottom menu.
- Step 2:** Select **Display...** from the side menu.
- Step 3:** Press **Date Time** in the sub-menu and select **On**. The current date and time will be displayed in the upper right-hand corner of the screen, as shown in Figure 4E-16.

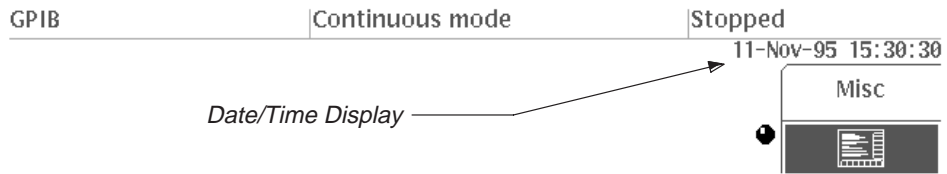
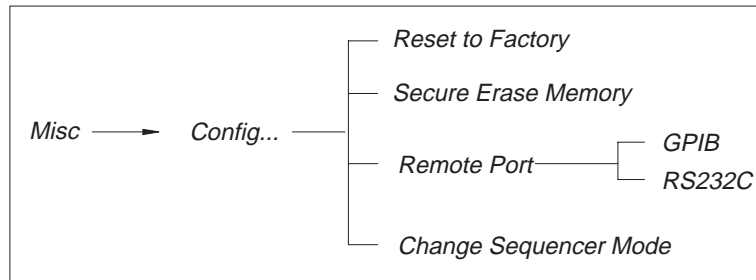

Figure 4E-16: Date/Time Display

Configuration



The following diagram shows the menu configuration for the **Config...** item.



In this section, we will discuss the **Reset to Factory**, **Secure Erase Memory**, and **Remote Port** items in the sub-menu.

Factory Settings

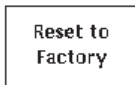

Select **Reset to Factory** to reset this instrument's settings to their factory values.

Procedure

- Step 1:** Select **Misc** from the bottom menu.
- Step 2:** Select **Config...** from the side menu.
- Step 3:** Select **Reset to Factory** from the sub-menu.
- Step 4:** The next message is displayed asking if it is OK to reset this instrument.

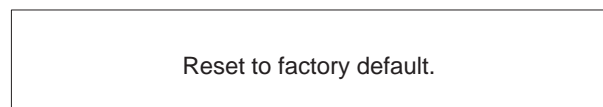

Answer **Cancel** or **O.K.** When you select **O.K.**, this instrument is reset to its factory settings and the **SETUP** menu is displayed. Resetting the instrument to factory default settings will not affect the data stored in the internal memory and the non-volatile RAM (NVRam). The factory settings are listed in Appendix D.

Deleting Data From Memory

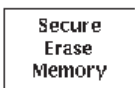

Use this item to delete the data stored in the internal memory and the non-volatile RAM (NVRam). This will also cause all values with the exception of **Date Time** (date and time) to be restored to their default settings. Default settings consist of the factory settings and the following items:

Remote Port	GPIB
GPIB Operating Mode	Talk/Listen
GPIB Address	1
RS-232-C Parameters	
Baudrate	9600
Data Bits	8
Parity	None
Stop Bits	1
Flagging	None

NOTE. Once deleted, data cannot be restored.

Procedure

- Step 1:** Select **Misc** from the bottom menu.
- Step 2:** Select **Config...** from the side menu.
- Step 3:** Select **Secure Erase Memory** from the sub-menu.
- Step 4:** The following message will appear, asking you to confirm that you really want to delete the data from memory:

Initializes both catalog memory and NVRam then puts all setups in the factory defaults.

Answer **Cancel** or **O.K.** If you select **O.K.**, all data will be deleted from memory and settings will be restored to factory defaults, and then the **SET-UP** menu will appear.

Remote Port Settings

Remote Port
GPIB
RS232C

This instrument's rear panel has two remote control interface ports: **IEEE STD 488** (GPIB) and **RS-232-C**. Select the desired port, depending on which interface you will be using.

Procedure

- Step 1:** Select **Misc** from the bottom menu.
- Step 2:** Select **Config...** from the side menu.
- Step 3:** Press the **Remote Port** key in the sub-menu and select either **GPIB** or **RS232C**. The remote interface port that you have selected will be displayed on the left side of the status line at the top of the screen.

Change
Sequencer
Mode

Setting the Hardware Sequencer

When the hardware sequencer is set to on, a hardware sequencer that provides high speed switching is available for the output of a sequence file. Using this, the repetition count of the waveforms in the sequence can be set unlimited by waveform memory length. Also, in the **Waveform Advance** mode, the instrument is able to output a waveform continuously.

When the hardware sequencer is set to off, each waveform in the sequence file is expanded into memory a number of times according to its repeat count.

NOTE. *When you change the hardware sequencer mode, the files in the catalog memory of the instrument are lost. Before changing the hardware sequencer mode, save the files that you do not want to lose in the instrument's nonvolatile memory or a floppy disk.*

This shows the setting procedures for the hardware sequencer.

Procedure

- Step 1:** Select **Misc** from the bottom menu.
- Step 2:** Select **Config...** from the side menu.
- Step 3:** Press **Change Sequencer Mode** button in the sub menu. The hardware changes from on to off or off to on. The current hardware sequencer state displays in the **Sequencer** Item of **UTILITY (MENU)** → **Misc** (bottom) → **Status** (side) → **System** (sub). See Figure 4E-20.
- Step 4:** When the hardware sequencer mode is changed, the instrument displays a message shown as Figure 4E-17 and asks for the confirmation. When you select **Cancel**, the hardware sequencer mode is not changed; when you select **O.K.**, the instrument initiates a reboot and the changed mode becomes available.

Change sequencer mode.
 Save files to disk or NVRam.
 Reboot comes after changing to sequencer on.

Figure 4E-17: Message for Changing Hardware Sequencer



Settings for Hard Copy Output

When you output a hard copy, you can choose to either save the data displayed on the screen on a floppy disk as a file, or output the data through the **IEEE STD 488** (GPIB) or **RS-232-C** interface.

When you select **Hardcopy...** from the side menu, you can select the format for the hard copy and the output port. The following diagram shows the menu configuration for the **Hardcopy...** item.

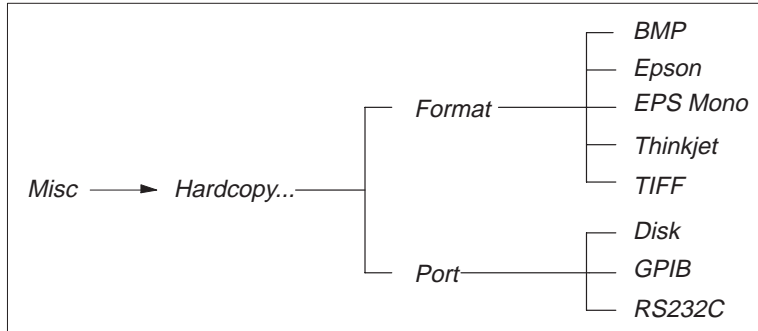

Selecting the Format



Use this item to select the output format for the hard copy. You may select any one of five formats: **BMP**, **Epson**, **EPS Mono**, **Thinkjet** or **TIFF**.

Format	
BMP	: Windows image file format
Epson	: ESC/P 9 & 24 pin dot matrix printer
EPS Mono	: Encapsulated Postscript mono image
Thinkjet	: Ink jet printer
TIFF	: Tag Image File Format

Figure 4E-18: Format Selection Menu

Table 4E-3 shows the extension for each format and gives a brief description of that format.

Table 4E-3: Format Extensions

Format	Extension	Explanation
BMP	BMP	A format for a Windows black & white image file
Epson	ESC	A format for output to a 9-pin or 24-pin dot matrix printer in ESC/P graphic mode.
EPS Mono	EPS	Encapsulated Postscript format for black & white image files.
Thinkjet	TJ	A format used for output to HP (Hewlett Packard) inkjet printers.
TIFF	TIF	TIFF format

Selecting the Port

Port

Use this item to select the port from which the hard copy will be output. Three choices are available: **Disk**, **GPIB** and **RS232C**.

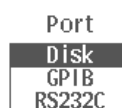

Figure 4E-19: Port Selection Menu

Procedure

In this example, you will get a hard copy of the **SETUP** menu in **TIFF** format from the **Disk** port.

- Step 1:** Select **Misc** from the bottom menu.
- Step 2:** Select **Hardcopy...** from the side menu.
- Step 3:** Select **Format** from the sub-menu.
- Step 4:** Use the general purpose knob to select **TIFF** format.
- Step 5:** Select **Port** from the sub-menu.
- Step 6:** Use the general purpose knob to select **Disc**.
- Step 7:** Select **Go Back** from the sub-menu.
- Step 8:** Insert a formatted disk into the disk drive of the instrument.
- Step 9:** Display the **SETUP** menu on the screen.

Step 10: Press the **HARDCOPY** button on the front panel.

A hard copy of the screen will be saved. The following message will appear in the message area:

Hardcopy in progress.

If you want to stop printing the hard copy in mid-process, press the **HARDCOPY** button again.

When the hard copy has been saved, the following message will appear:

Saved in SETUP000.TIF.

This means that the hard copy has been saved to the floppy disk in **TIFF** format under the file name **SETUP000**.

File names and extensions will be assigned automatically based on the menu and the format of the hard copy.

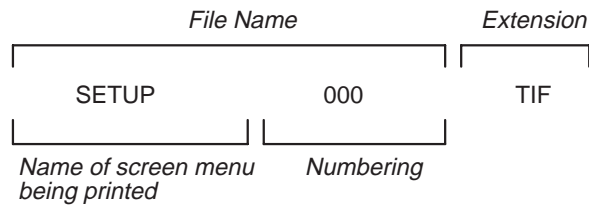

The file name is given the name of the screen menu being printed, as shown below.

Menu	File Name
SETUP	SETUP
MODE	MODE_
EDIT	EDIT_
LOAD/SAVE	LOAD_
UTILITY	UTIL_
F.G	FG_ _ _

Numbers will range from 0 to 999 for each menu.

Status Display

Status...

The following diagram shows the menu configuration for the **Status...** item.

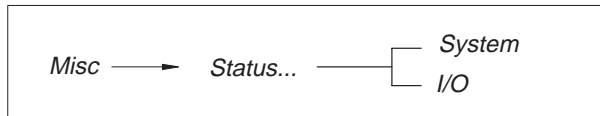

 System

System and GPIB/RS-232-C Status

Select **System** to display system and GPIB/RS-232-C status window. The system status comprises the instrument name, firmware version number, installation data for each board and so on.

The GPIB status is the address, and configuration. Status items other than the address and configuration are set by the remote controller.

The GPIB/RS-232-C status display consists of the following items: **PSC**, **Header**, **Verbose**, **Data** and **Debug**. In addition, the cumulative power-on time (**Up Time**) is displayed.

The **Sequencer** status in the bottom most line shows the selected hardware sequencer mode.

Procedure

- Step 1:** Select **Misc** from the bottom menu.
- Step 2:** Select **Status...** from the side menu.
- Step 3:** Select **System** from the sub-menu. System and GPIB/RS-232-C status data will be displayed, as shown in Figure 4E-20.

Model	AWG2041	
Version	FV: 1.00	
CPU Board	SRAM	512K Bytes, DRAM 6M Bytes
FPP Board	Installed	
Clock Board	Installed	
CH1	Installed	
CH1 Digital Out	Installed	
GPIB/RS232C		
Address	1	
Configuration	Talk/Listen	
PSC	1	
Header	1	
Verbose	1	
Data	Source	"CH1"
	Destination	"GPIB.WFM"
	Encdg	Rpbinary
	Width	2
Debug	Snoop	0, Delay 0.2 s
Up Time	0.050 hours	
Sequencer	On	

Figure 4E-20: Display When System is Selected



I/O Event Reporting

Use this item to display event reporting for the GPIB or RS-232-C interface. See the programmer's manual for more information on event reporting.

Procedure

- Step 1:** Select **Misc** from the bottom menu.
- Step 2:** Select **Status...** from the side menu.
- Step 3:** Select **I/O** from the sub-menu. Event reporting will be displayed, as shown in Figure 4E-21.

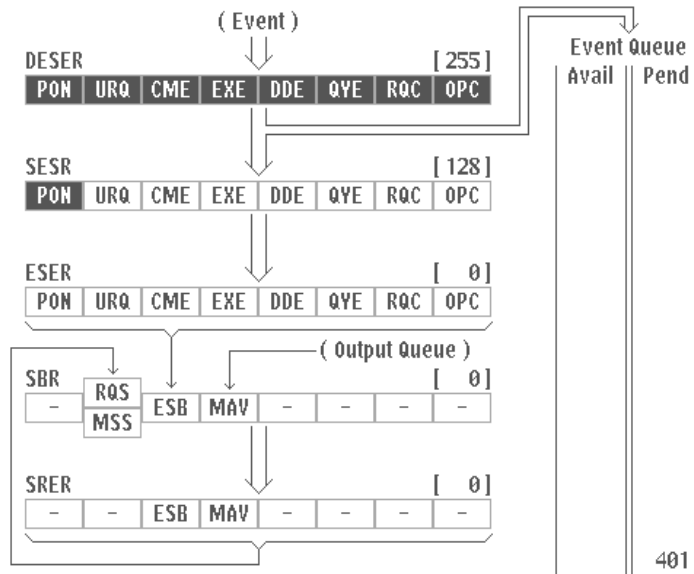

Figure 4E-21: I/O Event Reporting



Diagnostics

Diagnostics and Calibration

Use this item to run the diagnostics function or to calibrate the instrument.

Diagnostics

This instrument is equipped with diagnostics functions to comprehensively test itself. This makes it possible to check whether the instrument is operating correctly. A series of tests are automatically carried out when this instrument is started. These same diagnostics tests can also be initiated by selecting the **Diagnostics** item. These diagnostics are helpful when repairing this instrument. When the **Diagnostics** item is selected, the list of diagnostics items shown in Figure 4E-22 will appear.

Diagnostics	Result	Code
* Cpu	Pass	
* Clock	Pass	
* Display	Pass	
FPP	---	
* FrontPanel	Pass	
* Trigger	Pass	
* Setup CH1	Pass	
* Waveform Memory CH1	Pass	

Figure 4E-22: Diagnostics List

At the top of the diagnostics menu there are three columns giving the status of the diagnostic tests. The meaning of these three columns is as follows.

- Diagnostics** – This column gives the name of the diagnostic test item. The diagnostics may be executed individually or all together. **FPP** is valid if Option 09 is installed.
- Result** – This column gives the results of each test item. If no error is found in a test item, **Pass** is displayed. If an error is found, **Fail** is displayed. If Option 09 is not installed, the corresponding diagnostic items are not displayed and only " --- " is displayed in their place.

NOTE. The waveform outputs obtained with an instrument that has not passed all its tests are not reliable.

- **Code** – This column indicates an error code for the item where the error was detected.

NOTE. *If an error occurs, contact our representative closest to you.*

Procedure

- Step 1:** Select **Diag/Cal** from the bottom menu.
- Step 2:** Select **Diagnostics** from the side menu.
- Step 3:** Turn the general purpose knob to select the desired diagnostic item. To execute all the tests one after another, select **All**.
- Step 4:** Select **Execute** from the side menu. The selected diagnostics items are executed.

If the test finishes without a problem, **Pass** is displayed on the **Result** column. If an error occurs, **Fail** is displayed. If the instrument fails a test, an error code is displayed in the **Code** column.

Calibration

Calibration

This instrument is equipped with the system to calibrate itself. This enables the AWG2041 to operate with greater precision. A series of calibrations is carried out automatically when this instrument is started up. These same calibrations can also be initiated by selecting the **Calibration** item.

NOTE. *The AWG2041 must complete its warm up (about 20 minutes) and stabilize before calibration.*

When the **Calibration** item is selected, the list of calibration items shown in Figure 4E-23 will appear.

Function Waveform Generator Mode

General Description

Press the front panel **FG** button to switch this instrument from arbitrary waveform generation mode into function waveform generation (**FG**) mode. Select the desired waveform with the bottom button. Then set the output parameters with the side button. Hereafter, function waveform generator mode will be referred to as **FG** mode.

NOTE. *FG mode is an independent of the **MENU** column arbitrary waveform generation mode menus. Therefore, the output parameters set with the **SETUP** menu and the operation mode set with the **MODE** menu have no effect in **FG** mode.*

The following waveforms may be selected from the bottom menu:

- **Sine wave**
- **Triangle wave**
- **Square wave**
- **Ramp wave**
- **Pulse wave**

The following output parameters for these waveforms may be set from the side menu:

- **Frequency**
- **Amplitude**
- **Offset**
- **Polarity**
- **Polarity**
- **Duty** (pulse wave only)

When a sine wave is selected, a 50 MHz filter is inserted. When a waveform other than sine wave has been selected, Through (no filter) will be selected.

Table 4F-1 shows the relationship among the frequency, the waveform and the marker signal data point count.

Table 4F-1: Frequency, Waveform and Marker Signal Data Point Count

Frequency	Waveform	Marker Signal
$1\text{Hz} \leq f < 100\text{ kHz}$	10000(points)	1000(points)
$100\text{ kHz} \leq f < 1\text{ MHz}$	1000	100
$1\text{MHz} \leq f \leq 10\text{ MHz}$	100	10

Function Generator Menu Structure

Figure 4F-1 shows the configuration of the menus in FG mode:

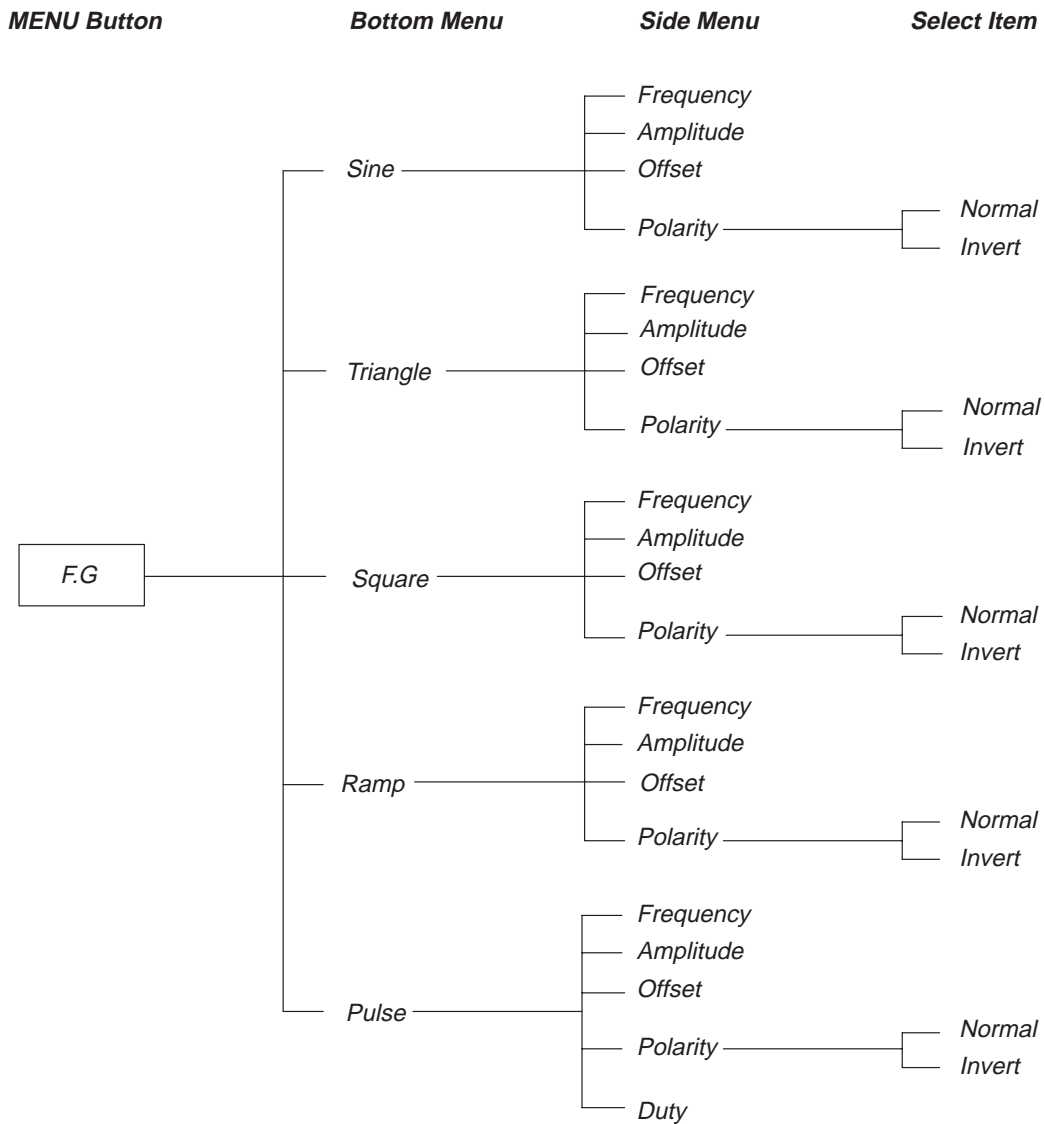

Figure 4F-1: FG Mode Menu Structure

Function Generator Menu Display

Figure 4F-2 shows the general display for the **FG** mode menu. A description for each callout follows.

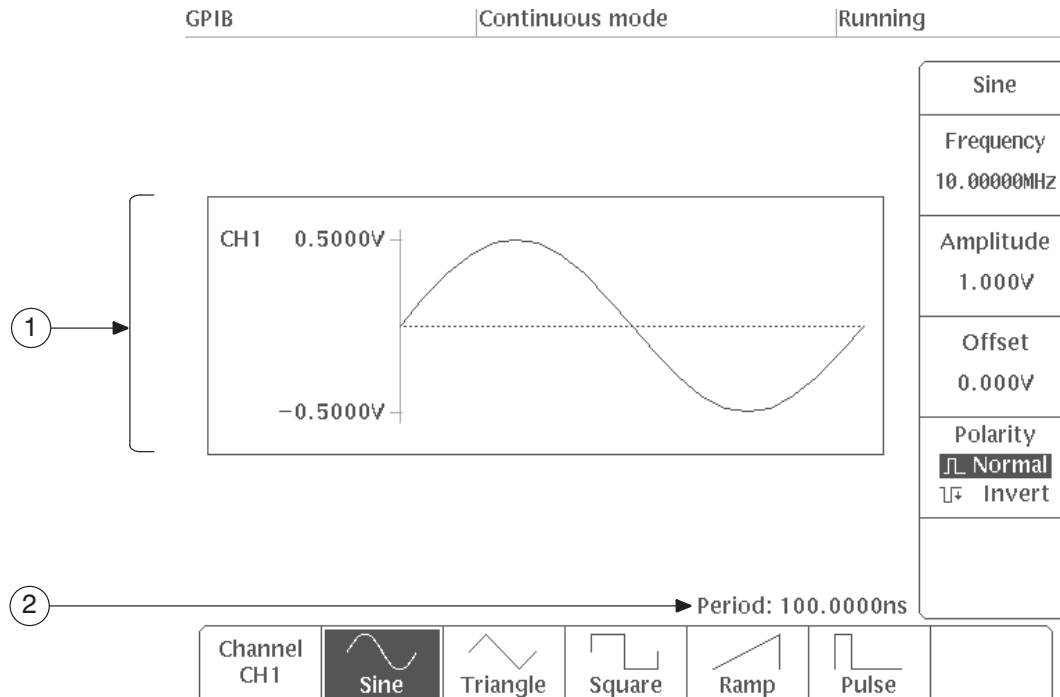

Figure 4F-2: FG Mode Menu Display

(1) Channel waveform display area

The waveform is displayed in this area. The peak voltage for the waveform is shown on the vertical axis; this value is determined by the amplitude or the offset setting. The horizontal axis (the dotted line in the center of the waveform) indicates the zero line; changing the offset will cause the zero line to move up or down.

(2) Waveform period

Shows the period for the waveforms.

Setting the Output Waveform

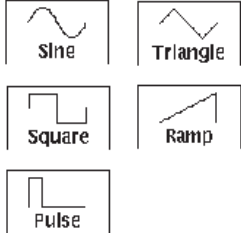

The following procedure is used to set the output waveform for a channel.

Channel

Since the AWG2041 has only one channel for output, pressing this button will have no effect.

Selecting the Waveform

- Step 1:** Press the bottom button corresponding to the desired type of waveform (**Sine**, **Triangle**, **Square**, **Ramp** or **Pulse**).

Setting the Output Parameters

- Step 2:** Select the output parameter item from the side menu and enter a value. For details, see "Setting the Output Parameters for the Waveform" on the next page.

Waveform Output

- Step 3:** Press the **ON/OFF** button for the channel to which the waveform is to be output. The selected waveform will be continuously output to that channel.

NOTE. In **FG** mode, the operation is always **Cont**, meaning that waveforms are output continuously.

Setting the Output Parameters for the Waveform

The output parameters are applied to all waveforms. Note that the pulse wave has an extra parameter, "**Duty**," which is only effective for pulse waves.

The following sections will focus on each of the items in the side menu for each waveform type.

Frequency

Setting the Frequency

This item sets the frequency. The frequency is set with a 7-digit number from 1.000000 Hz to 10.00000 MHz. The frequency is set with the numeric keys or the general purpose knob. Waveform periods (**Period**) are displayed at the bottom of the screen.

Amplitude

Setting the Amplitude

This item sets the waveform amplitude. The amplitude can be set in steps of 1 mV within the range 0.020 V ~ 2.000 V (P-P value). The amplitude is set with the numeric keys or the general purpose knob. Figure 4F-3 shows a sine waveform whose amplitude has been set to 2 V.

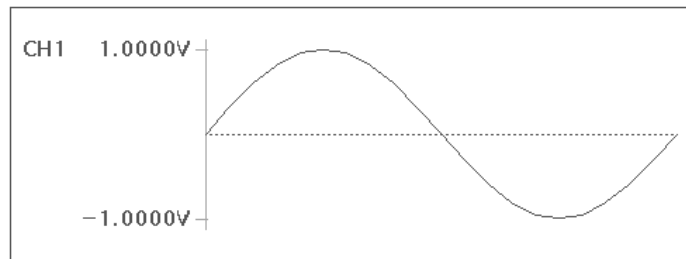

Figure 4F-3: Setting the Amplitude

Offset

Setting the Offset

This item sets the waveform offset. The offset for each waveform can be set in steps of 1 mV within the range ± 1.000 V. The offset is set with the numeric keys or the general purpose knob. Figure 4F-4 shows the waveform used in Figure 4F-3 after an offset of 0.5 V has been applied. The dotted line in the figure indicates the zero line.

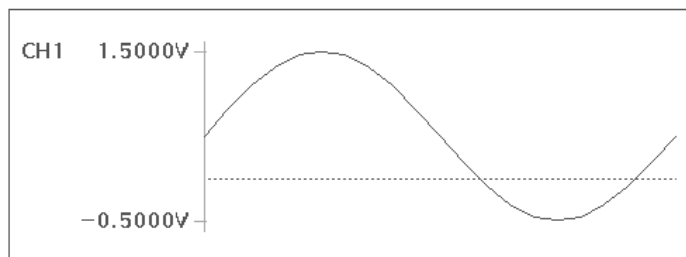

Figure 4F-4: Setting the Offset

Setting the Polarity



This item sets the output waveform polarity. Each time the **Polarity** button in the side menu is pressed, the polarity toggles between **Normal** and **Invert** and the polarity of the displayed waveform is reversed. See figure 4F-5. The figure below at left shows a Ramp wave whose polarity has been set to "Normal," the figure on the right shows a Ramp wave whose polarity has been set to "Invert."

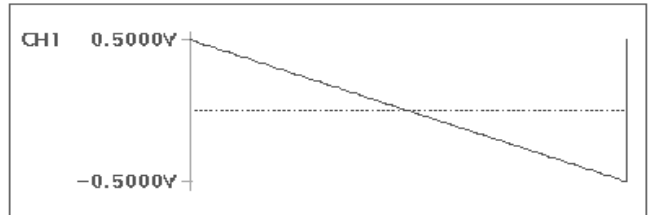
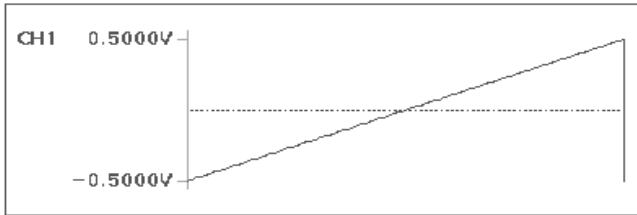

Figure 4F-5: Waveform Polarity

Setting the Duty



The **Duty** item appears in the side menu when the pulse wave is selected. This item allows you to set the duty ratio for pulse waveforms. The duty is set to 0 ~ 100% in steps of 1%. The Duty item is set with the numeric keys or the general purpose knob. When the duty is set to 0% or 100%, the wave will be DC. Figure 4F-6 shows a pulse waveform whose duty value has been set to 30%.

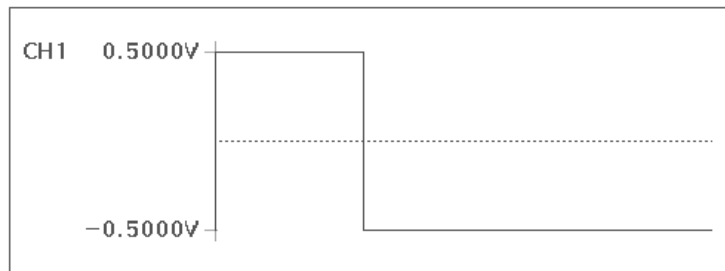

Figure 4F-6: Setting the Duty Value for a Pulse Wave

Marker Output

Marker signals are generated at the starting point for waveform data. Marker 1 is a positive pulse signal, while Marker 2 is the inverted Marker 1 signal. These signals are output from the **CH1 MARKER 1** and **CH1 MARKER 2** connectors, respectively, on the front panel. The duty ratio for the pulse is always set to 10%. See Table 4F-1. The output impedance is 50 Ω and marker output is 2.0 V for high level and 0.0 V for low level.

Appendices

Appendix A: Options and Accessories

This chapter will describe the options and accessories (both standard and optional) available for the AWG2041.

Options

The following options are available with this instrument.

- Option 01 (4M-word waveform memory)
- Option 03 (Digital data output)
- Option 09 (FPP board + FFT editor / convolution)
- Option 1R (Rack Mount)
- Option 1S (With WaveWriter S3F400)
- Option 95 (Certificate with Calibration Data)
- Option B1 (With Service Manual)

Each of these options will be discussed in detail in the following pages.

Option 01 (4M-word Waveform Memory)

This option expands the waveform output memory to 4M words.

Option 03 (Digital Data Output)

On AWG2041 arbitrary waveform generators for which Option 03 has been installed, digital data from the waveform memory is output directly to the **DIGITAL OUT** connectors on the rear panel without passing through the D/A converter.

Data Output

8-bit digital data at the ECL level (**D0 – D7**) is output from the SMB output connectors. At the same time that the analog waveform is output, the digital data can be obtained. The output requires 50Ω –2V termination.

Clock Output

The clock at the ECL level (**CLOCK**) is output from the SMB output connectors. The same clock that is fed to this instrument's internal D/A converter is output. The output requires 50Ω –2V termination.

Figure A-1 shows the digital output connectors.

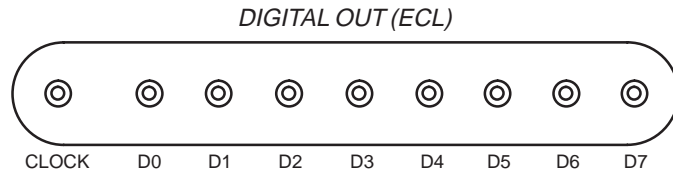

Figure A-1: Digital Output Connectors

Option 09 (FPP Board + FFT Editor, Convolution, Split/Join)

This option adds an FPP card (floating-point processor) for high-speed internal calculations/operations. This option provides three additional editors: an FFT editor, a convolution editor, and a split/join editor. See Section 4A for more information on the FFT, convolution and split/join editors.

Option 1R (Rack Mount)

The AWG2041 is shipped mounted in a 19-inch wide rack. In this configuration, the floppy disk drive is accessed from the front panel. To change an AWG2041 into a rackmounted version, contact Tektronix for information.

For further information regarding the rack mount adaptor, see the instruction sheet that comes with the rack mount kit.

Option 1S (With WaveWriter S3FT400)

WaveWriter is an application program used to create waveforms for advanced signal generating and processing instruments. Many Tektronix instruments, such as arbitrary waveform generators and oscilloscopes with the "save-on-delta" feature, are enhanced by this program. WaveWriter helps users configure waveforms with a minimum of effort.

With the WaveWriter package, you can create new waveforms or edit waveforms acquired from various instrument sources. WaveWriter gives you interactive control of the waveform generating process. WaveWriter operates within the Microsoft Windows™ environment.

A Certificate of Traceable Calibration is provided when this option is specified.

Option 95 (Certificate with Calibration Data)

A test result report will be provided with the AWG2041 when this option is specified.

Option B1 (With Service Manual)

This option adds a service manual.

Power Cord Options

The following power cords are available with this instrument.

Table A-1: Power Cord Options

Option	Description	Part Number
A1	Europe, 220V/6A	161-0104-06
A2	United Kingdom, 240V/6A	161-0104-07
A3	Australia, 240V/6A	161-0104-05
A4	North America, 240V/6A	161-0104-08
A5	Switzerland, 220V/6A	161-0167-00

Accessories

Standard Accessories

The AWG2041 includes the following standard accessories:

	Part Number
<ul style="list-style-type: none"> ■ Manual <ul style="list-style-type: none"> User Manual 070-9456-XX Programmer Manual 070-8657-XX ■ Floppy disk <ul style="list-style-type: none"> Sample Waveform Library Disk, 3.5-inch 063-1705-XX Sample program 063-1708-XX Performance Check Disk 063-1915-XX ■ Power cord 125V/6A 161-0230-01 ■ Certificate of Calibration 	

Optional Accessories

The following optional accessories are recommended for use with the instrument.

	Part Number
■ Service Manual	070-9457-XX
■ Front Cover	200-3232-XX
■ Accessory Pouch	016-1159-XX
■ GPIB Cable	012-0991-XX
■ 50Ω BNC Cable	012-1342-XX
■ 50Ω BNC Cable (double-shielded)	012-1256-XX
■ 50Ω SMB Cable	012-1458-XX
■ 50Ω SMB-BNC Cable	012-1459-XX
■ 50Ω BNC Terminator	011-0049-XX
■ 50Ω BNC Power Divider	015-0660-XX
■ 400 MHz BNC Low Pass Filter	015-0659-XX
■ 200 MHz BNC Low Pass Filter	015-0658-XX
■ 100 MHz BNC Low Pass Filter	015-0657-XX
■ Fuse 6A Fast (UL198G/3AG)	159-0239-XX
■ Fuse cap	200-2264-XX
■ Fuse 5A (T) (IEC127)	159-0210-XX
■ Fuse cap	200-2265-XX

Appendix B: Performance Characteristics

Introduction

The performance characteristics on the AWG2041 can be divided into three categories:

- Nominal Traits

General characteristics are described not by equipment performance and limits but by such things as memory capacity.

- Warranted Characteristics

Warranted characteristics are described in terms of quantifiable performance limits which are guaranteed.

- Typical Characteristics

Typical characteristics are described in terms of typical or average performance for the AWG2041. The characteristics described herein are not absolutely guaranteed.

Nominal Traits

This section will describe general characteristics of the AWG2041. These can be divided into two main categories: electrical characteristics and mechanical characteristics.

Electrical Characteristics

Characteristics	Description
Arbitrary Waveforms	
Waveform Memory Memory Length	1 M words x 8 bits 4 M words x 8 bits (Option 01)
Marker Memory Memory Length	1 M words x 2 bits 4 M words x 2 bits (Option 01)
H/W Sequencer	On or Off (Select On or Off with on-screen menu and GPIB control.)
Sequence Memory Memory Length	5460 steps maximum
Sequence Counter	1 to 65536 (H/W Sequencer : On)
Data Points of Waveform H/W Sequencer : On H/W Sequencer : Off	640 to 1M or 4M (Option 01) points in multiple of 32 32 to 1M or 4M (Option 01) points in multiple of 32
NVRAM	0.5 M bytes
Catalog Memory	4 M bytes 10 M bytes (Option 01)
Clock Generator	
Frequency Range	1.000 000 kHz~1.024 000 GHz
Resolution	7 digits
Reference Oscillator Nominal Frequency	16.77721 MHz
Main Output	
DA Converter Resolution	8 bits
Amplitude Range	20 mV to 2 V into 50 Ω
Resolution	1mV
Offset Range	-1.000 V to +1.000 V into 50 Ω

Electrical Characteristics

Characteristics	Description
Main Output (Continued)	
Resolution	1 mV
Impedance	50 Ω
Operating Modes	
Continuous	Generates the waveform or sequence continuously.
Triggered	Output quiescent until triggered by an GPIB, external, or manual trigger; then generates a waveform or sequence only one time.
Burst H/W Sequencer : Off	This operation is available only in H/W Sequencer off. Output quiescent until triggered by an external, GPIB or manual trigger; then generates a waveform/sequence up to 65536 times.
Gated	Same as Continuous mode, except waveforms or sequences are output for the duration of the gated signal.
Waveform Advance H/W Sequencer : On	Output quiescent until triggered by an external, GPIB, or manual trigger; then generates the waveform/sequence in the sequence file continuously until the next trigger signal.
H/W Sequencer : Off	Output quiescent until triggered by an external, GPIB, or manual trigger; then generates the waveform/sequence in the sequence file one time and waits the trigger for the next waveform output.
Autostep	Output quiescent until triggered by an GPIB, external, or manual trigger; then generates the waveform/sequence in the autostep file. When an autostep signal is received from the rear panel or the command is given manually, the instrument moves to the next waveform or sequence waveform in the autostep file. The output parameters (amplitude, offset, etc.) are changed.
Slave	Receive the master clock signal 650 MHz from the Master AWG2041 for the parallel operation.
Filters	
Type	Low pass filter with Bessel characteristics 100 MHz 50 MHz 20 MHz 10 MHz

Electrical Characteristics

Characteristics	Description
Auxiliary Output	
MARKER	
Level	−2.0 V to 2.0 V into 50 Ω (Hi/Lo)
Resolution	0.10 V
Number of Marker	2
Connector	BNC
BUSY	
Level	Positive polarity TTL pulse
Output Resistance	51 Ω
Connector	SMB
SYNC	
Level	Positive polarity TTL pulse
Output Resistance	51 Ω
Connector	SMB
MASTER CLOCK	
Level	100K ECL compatible
Connector	SMB
Digital Data Out (Option 03)	
Output Signal	Data (D0 to D7), Clock
Level	100K ECL compatible
Connector	SMB

Electrical Characteristics

Characteristics	Description
Auxiliary Input	
TRIGGER	
Threshold Level	–5 V to 5 V
Resolution	0.1 V
Impedance	1 k Ω or 50 Ω
Connector	BNC
STOP TRIGGER	
Threshold Level	TTL
Impedance	10 k Ω
Connector	SMB
AUTO STEP TRIGGER	
Threshold Level	TTL
Impedance	10 k Ω
Connector	SMB
EXTERNAL CLOCK	
Impedance	50 Ω , AC Coupling
Connector	SMB
SLAVE CLOCK	
Threshold Level	100K ECL
Impedance	50 Ω , terminated to –2.0 V
Display	
CRT	
Display Area	13.2 cm (5.2 inches) horizontally by 9.9 cm (3.9 inches) vertically
Resolution	640 (H) x 480 (V) pixels

Electrical Characteristics

Characteristics	Description
Function Generator	
Waveform Shape	Sine, Triangle, Square, Ramp, Pulse
Output Parameter	
Frequency	1.000 000 Hz to 10.000 00 MHz
Amplitude	20 mV to 2 V into 50 Ω, can be set in 1 mV increments
Offset	–1.000 V to 1.000 V into 50 Ω, can be set in 1 mV increments
Polarity	Normal, Invert
Duty	0% to 100%, Pulse only, can be set in 1% increments
Operating Mode	Continuous mode
Auxiliary Output	
Marker	2 V into 50 Ω, generated at the starting point of the waveform. The duty ratio for the pulse is 10%.
AC Power Source	
AC Line Power	
Fuse Rating	6 A first blow, 250 V, UL198G (3AG) or 5 A (T), 250 V, IEC127
Battery	
Type	Li3 V, 650 mAh

Mechanical Characteristics

Characteristics	Description
Net Weight	
Standard	10.5 kg
Size	
Height	164 mm (6.4 inches.) with feet
Width	362 mm (14.3 inches.) with handle
Length	491 mm (19.25 inches.) with front cover 576 mm (22.2 inches.) with handle extended

Warranted Characteristics

This section will describe the warranted characteristics of the AWG2041. These can be divided into two main categories: electrical characteristics and environmental characteristics.

Performance Conditions

The electrical characteristics are valid under the following conditions:

- 1) The instrument must have been calibrated at an ambient temperature between +20° C to +30° C.
- 2) The instrument must be in an environment whose limits are described in Environmental Characteristics.
- 3) All tolerance limits apply after a 20 minute warm up and an execution of the self calibration.
- 4) The instrument is operating at an ambient temperature between +10° C to +40° C, unless otherwise noted.

Electrical Characteristics

Characteristics	Description
Clock Generator	
Stability	±1 ppm/year (20° C to 30° C)
Accuracy	±1 ppm
Phase noise	-75 dBc/Hz at 1 GHz (10 kHz offset)
Jitter	20 ps rms at 1 GHz (calculated from the phase noise from 100 Hz to 200 kHz)
Main Output	
DA Converter	
DNL	Within 0.5 bit
INL	Within 1 bit
Output Volts	-2.0 V to +2.0 V into 50 Ω
Amplitude	No offset
DC Accuracy	± (1% of amplitude + 2 mV)
Offset	Waveform data; 7F, No Filter, Amplitude 20 mV.
Accuracy	± (1% of offset + 5 mV)
Reverse Power Protection	Up to 0.4 W.

Electrical Characteristics

Characteristics	Description
Main Output (Continued)	
Pulse Response	Clock 1 GHz, Waveform Data; 00 and FF, No Filter, No offset (measured in the 500 MHz BW).
Rise Time	2.5 ns maximum (when the amplitude is greater than 1.0 V) 1.5 ns maximum (when the amplitude is smaller than and equal to 1.0 V)
Aberration	Within $\pm 10\%$ (when the amplitude is greater than 1.0 V) Within $\pm 7\%$ (when the amplitude is smaller than and equal to 1.0 V)
Flatness	Within $\pm 3\%$ (After 50 ns from rise/fall edges)
Sine Wave Characteristics	Clock 1 GHz, Waveform Point 32, Frequency 31.25 MHz, Amplitude 1.0 V, No Filter, No offset.
Harmonics	-45 dBc maximum (DC to 400 MHz)
Noise	-50 dBc maximum (DC to 400 MHz)
Phase Noise	-90 dBc/Hz at 10 kHz offset
Auxiliary Output	
MARKER	
Level	-2.0 V to +2.0 V into 50 Ω -4.0 V to +4.0 V into 1M Ω
Accuracy	Within ± 0.1 V $\pm 5\%$ of setting
BUSY	
Delay	Within 60 ns from the external trigger (see T_{d4} in Figure B-1) Within 150 ns of the end of waveform output (see T_{d7} in Figure B-1)
SYNC	
Delay	Within 60 ns from the external trigger (see T_{d3} in Figure B-1)
Digital Data Out (Option 03)	
Skew Between Data	Within ± 250 ps

Electrical Characteristics

Characteristics	Description
Auxiliary Input	
TRIGGER	
Accuracy	$\pm(5\% \text{ of Level} + 0.1 \text{ V})$
Pulse Width	10 ns minimum (with an amplitude of 0.2 V)
Sensitivity	0.2 V minimum (with a square wave of 1 MHz)
Maximum Input Volts	$\pm 10 \text{ V}$ (DC + peak AC) when an input impedance of 1 k Ω is selected $\pm 5 \text{ V}$ (DC + peak AC) when an input impedance of 50 Ω is selected
Delay	To marker from trigger (see T_{d2} in Figure B-1)
Internal Clock	Within (45 ns + 3 clocks) (at 650 MHz or greater) Within 60 ns (at less than 650 MHz)
External Clock	Within (45 ns + 3 clocks)
Jitter	
Internal Clock	Within $\pm(0.5 \text{ clocks} + 200 \text{ ps})$ (at 650 MHz or greater) Within $\pm 0.8 \text{ ns}$ (at less than 650 MHz)
External Clock	Within $\pm(0.5 \text{ clocks} + 200 \text{ ps})$
Trigger Hold Off	500 ns maximum
STOP TRIGGER	
Pulse Width	100 ns minimum
Maximum Input Volts	0 V to +5 V (DC + peak AC)
Delay	100 ms maximum
AUTO STEP TRIGGER	
Pulse Width	100 ns minimum
Maximum Input Volts	0 V to +5 V (DC + peak AC)
Delay	100 ms maximum

Electrical Characteristics

Characteristics	Description
Auxiliary Input (Continued)	
EXTERNAL CLOCK	
Input Frequency Range	10 MHz to 1 GHz
Sensitivity	400 mVp-p (-4.0 dBm)
Maximum Input Volts	1.0 V _{p-p} (+4.0 dBm), DC ±20 V
SLAVE CLOCK	
Maximum Input Volts	-2.0 V to 0.0 V
Frequency Range	650 MHz to 1.0 GHz
Function Generator	
Frequency Accuracy	±1 ppm
Sine Wave Characteristics	
Flatness	Within ±1 dB (100 kHz reference)

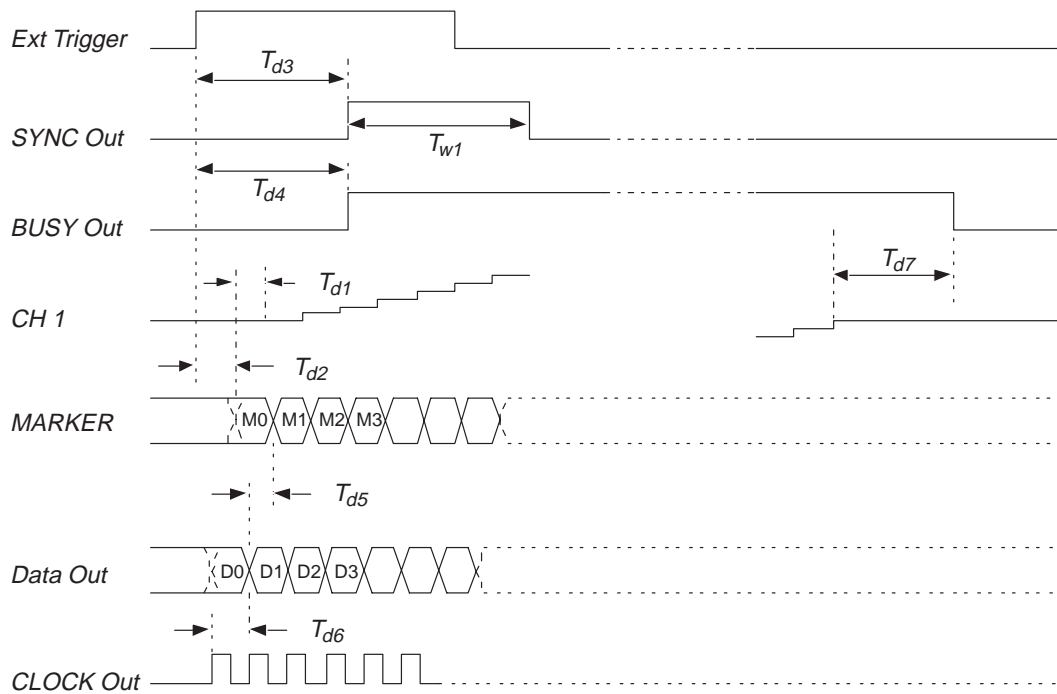

Figure B-1: Trigger Delay

Electrical Characteristics

Characteristics	Description
AC Power Source	
Voltage	
Range	
90 VAC to 250 VAC	48 Hz to 63 Hz
90 VAC to 127 VAC	48 Hz to 440 Hz
Maximum Power Consumption	300 W
Maximum Current	4 A

Environmental Characteristics

Characteristics	Description
Temperature	
Operating	+10° C to +40° C
Non operating	-20° C to +60° C
Relative Humidity	
Operating	20% to 80% (No condensation) Maximum wet-bulb temperature 29.4° C
Non operating	5% to 90% (No condensation) Maximum wet-bulb temperature 40.0° C
Altitude	
Operating	To approx. 4.5 km (15 000 ft). Maximum operating temperature decreases 1° C each 300 m above 1.5 km.
Non operating	To approx. 15 km (50 000 ft).

Environmental Characteristics

Characteristics	Description
Dynamics	
Vibration Operating	0.33 mm _{p-p} , 10 to 55 Hz, 15 minutes
Shock Non operating	294 m/s ² (30 G), half-sine, 11 ms duration.
Safety	
Third Party Certification	UL1244 CSA C22.2 No.231
Self-Declaration	IEC 1010-1
Electromagnetic Compatibility	
EMC	
Emissions	
Enclosure	EN55011 Class A limits for radiated emissions
AC Main	EN55011 Class A limits for conducted emissions EN60555-2 Power Line Harmonics
Immunity	
Enclosure	IEC 801-3 Electromagnetic Field, 10 V/m, 27 MHz to 500 MHz (up to 200 mV _{p-p} noise may be output in this test.) IEC 801-2 ESD, 8 kV
AC Main	IEC 801-4, 4 kV _{p-p} , 5/50 ns T _r /T _h , 5 kHz
Installation Requirements	
Power Consumption (Fully Loaded)	300 watts max. Maximum line current is 4 Arms at 50 Hz, 90 V line.
Surge Current	30 A peak for < 5 line cycles, after product has been off for at least 30 s.
Cooling Clearance	
Top	7.5 cm (3 inches)
Side	15 cm (6 inches)
Rear	7.5 cm (3 inches)

Typical Characteristics

This section will describe the typical characteristics for the AWG2041. These values represent typical or average performance and are not absolutely guaranteed.

Electrical Characteristics

Characteristics	Description
Main Output	
Small Signal Bandwidth	250 MHz (Amplitude=0.5 V)
Filters	
Rise Time	
10MHz	35 ns
20MHz	17 ns
50MHz	7.0 ns
100MHz	3.5 ns
Delay	Delay from marker (see T_{d1} in Figure B-1)
10MHz	42 ns
20MHz	22 ns
50MHz	12 ns
100MHz	7.0 ns
Through	2.5 ns
Auxiliary Output	
MARKER	
Rise/Fall Time	Within 1ns (at 1 V_{p-p})
Marker Skew	Within 250 ps
SYNC	
Signal Duration	100 ns (see T_{w1} in Figure B-1)
Auxiliary Input	
EXTERNAL CLOCK	
Delay	13 ns from external clock to marker
Digital Data Out (Option 03)	
Delay	
Data to Marker	2.0 ns (see T_{d5} in Figure B-1)
Clock to Data	2.5 ns (see T_{d6} in Figure B-1)
Power Supply	
Battery	
Back Up Time	4 years

Appendix C: Sample Waveform Library

Introduction

The files listed below are included in the route directory of the sample waveform library disk that comes with the instrument. All files are locked; this is indicated by an asterisk (*) before the file name.

■ Representative Waveform Files

There are 14 of these waveform files. If a waveform file (with the extension **.WFM**) has the same name as an equation file (with the extension **.EQU**), the waveform file was derived by compiling that equation file.

	Waveform Name	File Name	Page
1	Gaussian Pulse	GAUSS_P.EQU GAUSS_P.WFM	C-2
2	Lorentz Pulse	LORENTZ.EQU LORENTZ.WFM	C-3
3	Sampling Function SIN(X)/X Pulse	SINC.EQU SINC.WFM	C-4
4	Squared Sine Pulse	SQU_SIN.EQU SQU_SIN.WFM	C-5
5	Double Exponential Pulse	D_EXPEQU D_EXP.WFM	C-6
6	Nyquist Pulse	NYQUIST.EQU NYQUIST.WFM	C-7
7	Linear Frequency Sweep	LIN_SWPEQU LIN_SWP.WFM	C-8
8	Log Frequency Sweep	LOG_SWPEQU LOG_SWP.WFM	C-9
9	Amplitude Modulation	AM.EQU AM.WFM	C-10
10	Frequency Modulation	FM.EQU FM.WFM	C-11
11	Pulse Width Modulation	PWM.WFM	C-12
12	Pseudo-Random Pulse	PRBS15.WFM	C-13
13	Waveform for Magnetic Disk Writing Signal	MDSK_WR.WFM	C-14
14	Waveform for Magnetic Disk Readout	MDSK_RD.WFM	C-15

Description of Representative Waveform Files

Here we will describe the 14 representative waveform files. Some of the waveform files were obtained by creating an equation file in the equation editor and then compiling it to form a waveform file. Others were created in the waveform editor. To output a waveform file, select the file in the **SETUP** menu.

Gaussian Pulse (GAUSS_P.WFM)

Made with the equation editor.

```
# gaussian pulse
range(0, 640ns)
k0=30e-9      # pulse width
k1=320e-9     # peak location
exp(-ln(2)*((2*(t-k1)/k0)^2))
```

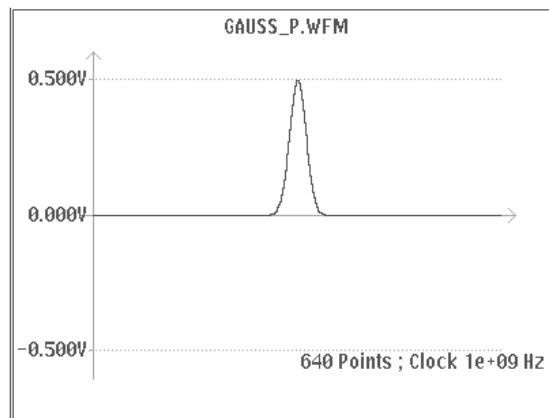

Figure C-1: Gaussian Pulse Formula and Waveform

Constants

k0 indicates the half width (W50) for the pulse; K1 indicates the peak location of the pulse.

Description

The waveform generated when the pulse width is taken to be t_{w50} and the peak location is taken to be 0 can be expressed as

$$V(t) = \exp\left\{-\ln(2) \cdot \left(\frac{2t}{t_{w50}}\right)^2\right\}. \text{ Substituting } \sigma = \frac{t_{w50}}{2\sqrt{2\ln(2)}} \text{ gives}$$

$$f(t) = \exp\left(-\frac{t^2}{2\sigma^2}\right), \text{ and taking the Fourier transform gives}$$

$$F(j\omega) = \sqrt{2\pi}\sigma \cdot \exp\left(-\frac{\omega^2\sigma^2}{2}\right). \text{ This shows that this signal has a Gaussian form in the frequency domain as well.}$$

<Example> When t_{w50} is 30 ns, the bandwidth will be 10.4 MHz.

Settings

Waveform points: 640
 Clock frequency: 1.0 GHz
 Output time: 640 ns

Lorentz Pulse (LORENTZ.WFM)

Made with the equation editor.

```
# lorentz pulse
range(0, 1024ns)
k0=20e-9      # pulse width
k1=512e-9    # peak location
1/(1+(2*(t-k1)/k0)^2)
```

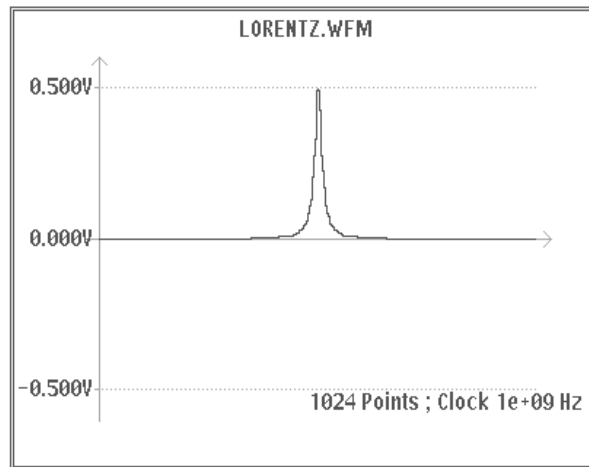

Figure C-2: Lorentz Pulse Formula and Waveform

Constants

k0 indicates the half width (W50) for the pulse; K1 indicates the peak location of the pulse.

Description

When the pulse width is taken to be t_{w50} , the waveform can be expressed by the following formula:

$$V(t) = \frac{1}{1 + \left(2 \frac{t}{t_{w50}}\right)^2}$$

Settings

Waveform points: 1024
 Clock frequency: 1.0 GHz
 Output time: 1024 ns

Sampling Function SIN(X)/X Pulse (SINC.WFM)

Made with the equation editor.

```
# sinc pulse
range(0,2048ns)
k0=50e6      # sine frequency
k1=1024e-9   # peak location
sin(2*pi*k0*(t-k1))/(2*pi*k0*(t-k1))
```

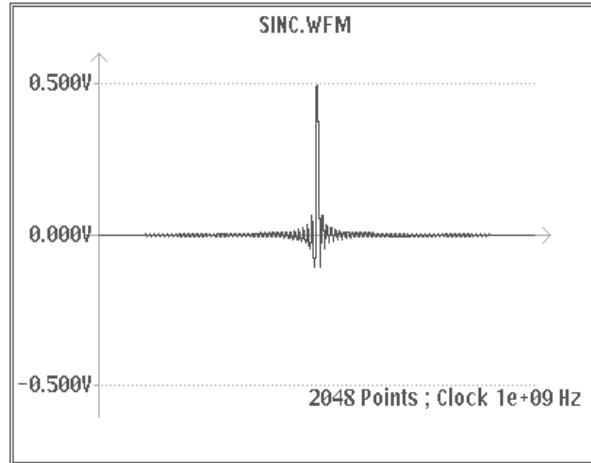

Figure C-3: Sampling Function SIN(X)/X Pulse Formula and Waveform

Constants

k0 indicates the frequency of the sine wave; k1 indicates the peak location of the pulse.

Description

In general, this waveform is expressed by the following formula:

$$V(t) = \frac{\sin(2\pi ft)}{2\pi ft}$$

This is the impulse response for the ideal low pass filter for the frequency bandwidth f. At least 42 periods are required in order to use a vertical resolution of 8 bits.

Settings

- Waveform points: 2048
- Clock frequency: 1.0 GHz
- Output time: 2048 ns

Squared Sine Pulse (SQU_SIN.WFM)

Made with the equation editor.

```
# squared sine pulse
range(0, 412ns)
0
range(412ns, 612ns)
(cos(2*pi*(x-0.5))+1)/2
range(612ns, 1024ns)
0
```

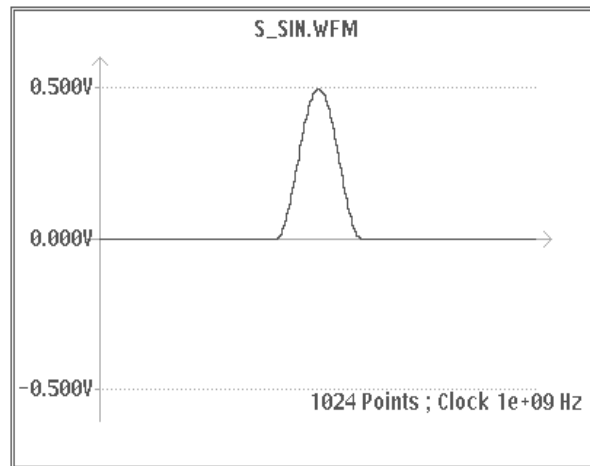

Figure C-4: Squared Sine Pulse Formula and Waveform

Description

The pulse width and peak location are set with **range()**.
The value for x is a value between 0 and 1 for **range(a,b)**.

Settings

Waveform points: 1024
Clock frequency: 1.0 GHz
Output time: 1024 ns

Double Exponential Pulse (D_EXP.WFM)

This is the rising and falling exponential function pulse. Made with the equation editor.

```
# double exponential pulse
range(0,10240ns)
k1=50e-9      # rise time constant
k2=1000e-9   # fall time constant
exp(-t/k2)-exp(-t/k1)
norm()
```

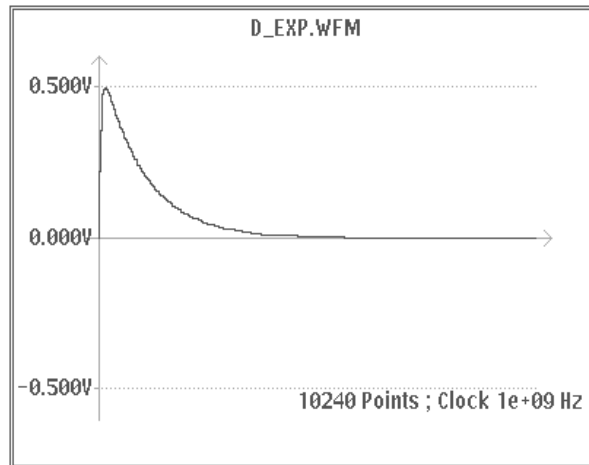

Figure C-5: Double Exponential Pulse Formula and Waveform

Constants

k1 and k2 are the rising and falling time constants, respectively. The peak location for the pulse is derived using the following formula:

$$\frac{k1 \cdot k2}{k2 - k1} \cdot \ln \frac{k2}{k1}$$

Description

This is the waveform when a charged capacitor is discharged to the RC circuit. When the time constants for charging and discharging are taken to be τ_1 and τ_2 , respectively, the waveform can be expressed by the following formula:

$$V(t) = \exp\left(-\frac{t}{\tau_2}\right) - \exp\left(-\frac{t}{\tau_1}\right)$$

Settings

Waveform points: 10240
 Clock frequency: 1.0 GHz
 Output time: 10240 ns

Nyquist Pulse (NYQUIST.WFM)

Made with the equation editor.

```
# nyquist pulse
range(0,1024ns)
k0=50e-9 # data period
k1=512e-9 # peak location
k2=0.5 # excess bandwidth factor 0 to 0.5
cos(pi*k2*(t-k1)/k0)/(1-(2*k2*(t-k1)/k0)^2)
v*sin(pi*(t-k1)/k0)/(pi*(t-k1)/k0)
```

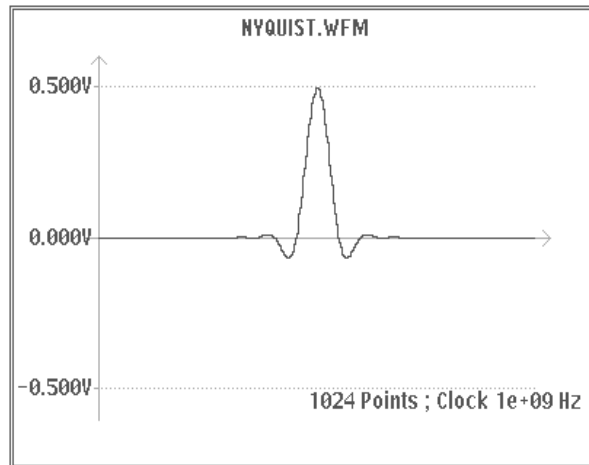

Figure C-6: Nyquist Pulse Formula and Waveform

Constants

k0 is the period of the digital data used in communication or recording. k1 is the pulse peak location and k2 is the transient frequency band factor, and is a value between 0 to 1.

Description

This is the impulse response of a wave shaping Nyquist filter. The shoulder characteristics of this filter are referred to as "cosine roll-off" characteristics, and the bandwidth used can be varied. This waveform can be expressed by the following formula.

$$V(t) = \frac{\cos\left(\frac{\pi\alpha t}{T}\right)}{1 - \left(\frac{2\alpha t}{T}\right)^2} \cdot \frac{\sin\left(\frac{\pi t}{T}\right)}{\frac{\pi t}{T}}$$

Here T is the data period and α is a value between 0 and 1. A wider band is required for values closer to 1, where ripple is reduced and implementation is easier.

Settings

Waveform points: 1024
 Clock frequency: 1.0 GHz
 Output time: 1024 ns

Linear Frequency Sweep (LIN_SWP.WFM)

Made with the equation editor.

```
# frequency sweep sine (linear)
range(0, 8us)
k0=8e-6      # sweep period
k1=1e6       # starting frequency
k2=10e6      # ending frequency
sin(2*pi*k1*t+2*pi*(k2-k1)*(t^2)/2/k0)
```

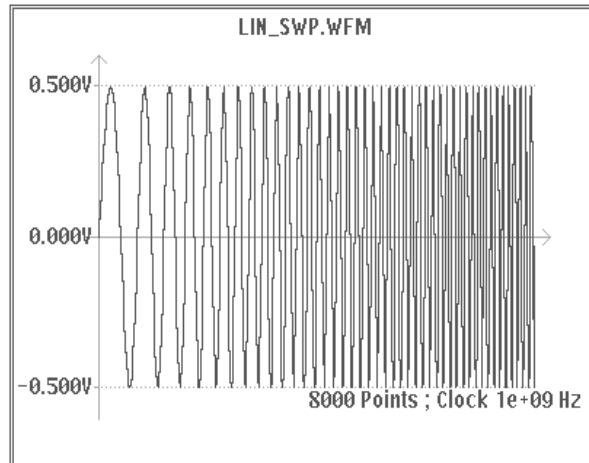

Figure C-7: Linear Frequency Sweep Formula and Waveform

Constants

k0 is the sweep period and k1 and k2 are the starting and ending frequencies.

Description

This waveform can be expressed generally by the following formula.

$$V(t) = \sin \left[2\pi f_1 t + 2\pi f_2 \int_0^t \frac{t}{T} dt + \phi_0 \right]$$

Here f_1 is the starting frequency, f_2 is the ending frequency, ϕ_0 is the initial phase, and T is the sweep period.

To assure that the phases match when this waveform is iterated, the sweep period is set to be close to an integer multiple of the reciprocal of the average frequency $\frac{f_1 + f_2}{2}$.

Settings

- Waveform points: 8000
- Clock frequency: 1.0 GHz
- Output time: 8 μ s

Log Frequency Sweep (LOG_SWP.WFM)

Made with the equation editor.

```
# frequency sweep sine (log)
range(0,11us)
k0=11e-6      # sweep period
k1=1e6        # starting frequency
k2=10e6       # ending frequency
k3=ln(k2/k1)
sin(2*pi*k1*k0/k3*(exp(k3*x)-1))
```

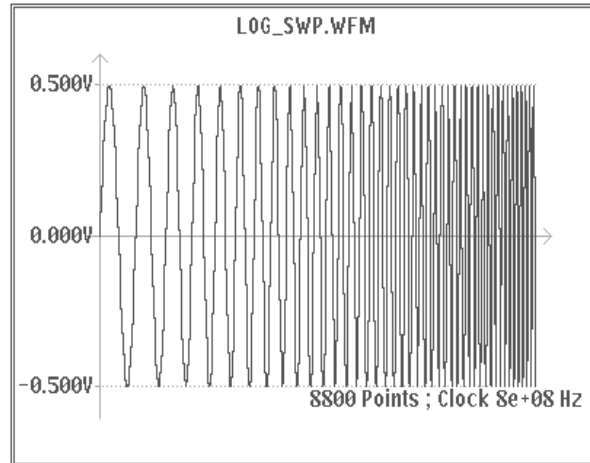

Figure C-8: Log Frequency Sweep Formula and Waveform

Constants

k0 is the sweep period and k1 and k2 are the starting and ending frequencies.

Description

This waveform can be expressed generally by the following formula.

$$V(t) = \sin \left[2\pi f_1 \int_0^t \exp \left(\frac{t}{T} \cdot \ln \frac{f_2}{f_1} \right) dt + \phi_0 \right]$$

Here f_1 is the starting frequency, f_2 is the ending frequency, Φ_0 is the initial phase, and T is the sweep period.

To assure that the phases match when this waveform is iterated, the sweep period is set to be close to an integer multiple of the reciprocal of the

average frequency $\left(\frac{f_2 - f_1}{\ln \frac{f_2}{f_1}} \right)$.

Settings

Waveform points: 8800
Clock frequency: 800 MHz
Output time: 11 μ s

Amplitude Modulation (AM.WFM)

Made with the equation editor.

```
# amplitude modulation  
range(0,0.25ms)  
k1=4000          # modulation frequency  
k2=10e6         # carrier frequency  
k3=0.5          # modulation degree  
  
(1+k3*cos(2*pi*k1*t))*cos(2*pi*k2*t)  
norm()
```

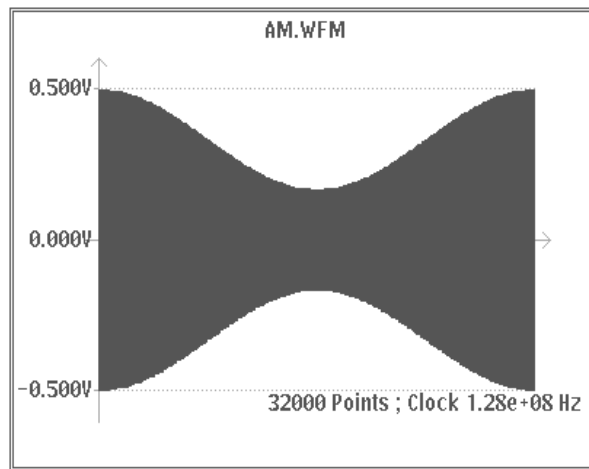

Figure C-9: Amplitude Modulation Formula and Waveform

Constants

k0 is the frequency of the modulating signal, k1 is the carrier frequency, and k2 is the modulation factor.

Description

This example shows a double sideband (DSB) amplitude modulated waveform with a modulation factor of 0.5. The modulating signal is a cosine wave.

Settings

Waveform points: 32000
Clock frequency: 128 MHz
Output time: 0.25 ms

Frequency Modulation (FM.WFM)

Made with the equation editor.

```
# frequency modulation
range(0, 40us)
k0=25e3      # signal frequency
k1=100e6    # carrier frequency
k2=60.12e3  # frequency deviation
sin(2*pi*k1*t+k2/k0*sin(2*pi*k0*t))
```

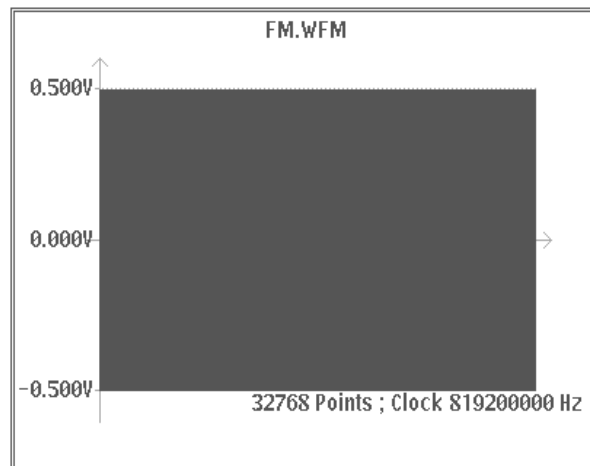

Figure C-10: Frequency Modulation Formula and Waveform

Constants

k_0 is the modulation signal frequency, k_1 is the carrier frequency, and k_2 is the frequency deviation.

Description

k_0 is the frequency of the cosine wave that is used to modulate a sine wave of frequency k_1 . To assure that the phases match when this waveform is iterated, the carrier frequency times the modulating signal period is set to be an integer. The modulation index is given by k_2/k_0 .

Settings

Waveform points: 32768
 Clock frequency: 819.2 MHz
 Output time: 40 μ s

Pulse Width Modulation (PWM.WFM)

Made with the waveform editor.

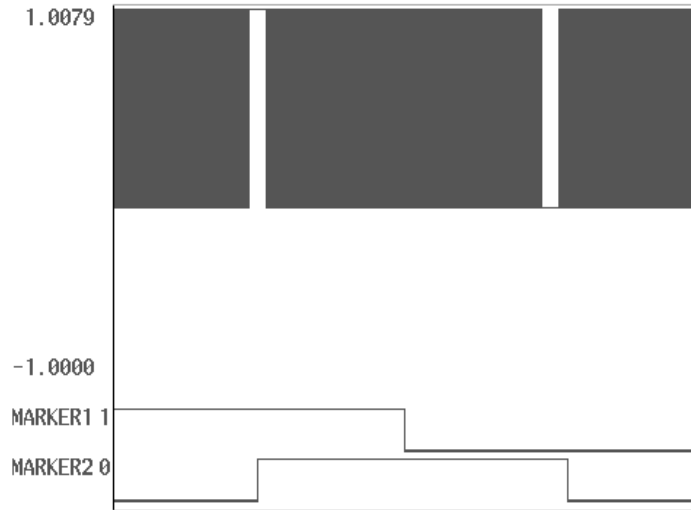

Figure C-11: Pulse Width Modulation Waveform

Description

The waveform editor is used to create a ramp wave of 1000 periods and a sine wave of 1 period, and these two waveforms are compared to create the PWM.WFM waveform.

Settings

Waveform points: 32000
Clock frequency: 1.0 GHz
Output time: 32 μ s

Pseudo-Random Pulse (PRBS15.WFM)

Made with the waveform editor.



Figure C-12: Pseudo-Random Pulse Waveform

Description

An M-series pseudo-random signal is created using the waveform editor's timing display shift register generator function.

Register length = 15
 Points/step = 2
 The encoding is NRZ.

To output repeatedly, specify 16 output repetitions in the sequence waveform editor.

Settings

Waveform points: 65534 $(2^{15}-1) \times 2$
 Clock frequency: 1.0 GHz
 Output time: 65.534 μ s

Waveform for Magnetic Disk Writing Signal (MDSK_WR.WFM)

Made with the waveform editor.

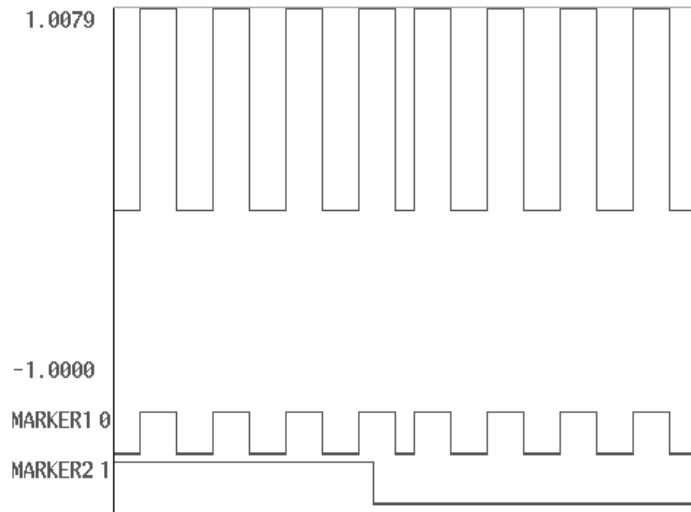

Figure C-13: Waveform for Magnetic Disk Writing Signal

Description

Creates a worst-case pattern with NRZ-I modulation using the bit set function of the timing editor.

* Worst-case pattern (~ 0101010110101010 ~)

Pattern length: 32

Points/step = 8

The encoding is NRZ-I.

A signal with the same pattern is set for the marker 1 as well.

Settings

Waveform points: 640

Clock frequency: 1.0 GHz

Output time: 640 ns

Waveform for Magnetic Disk Readout (MDSK_RD.WFM)

Made with the convolution waveform editor (Option 09).

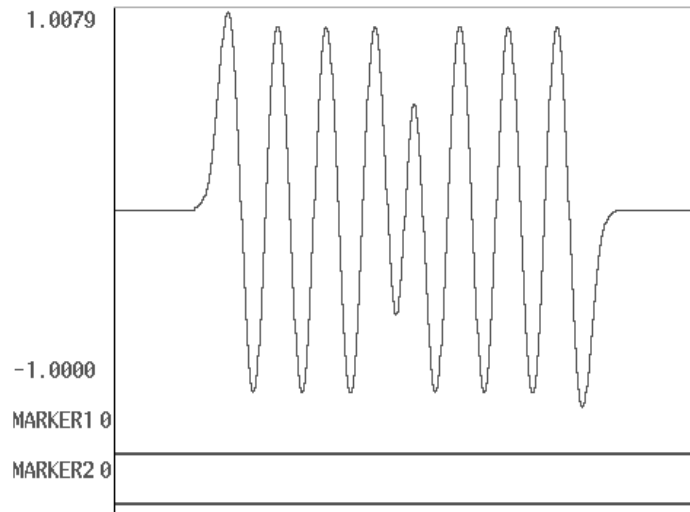

Figure C-14: Waveform for Magnetic Disk Readout

Description

Created using the waveform editor and the optional convolution waveform creation function.

This is the waveform for reading stored data written with 13: MDSK_WR.WFM. This is a waveform created assuming a Gaussian pulse (**GAUSS_P EQU**) with a system impulse response of 1: [pulse width 30 ns (clock 1.0 GHz, 640 points)]

Settings

Waveform points: 1280
 Clock frequency: 1.0 GHz
 Output time: 1.28 μ s

Appendix D: Miscellaneous

General Description

This appendix covers the following items.

- Horizontal axis scaling
- Sampling theorem
- Differentiation
- Integration
- Random (rnd) function
- Pattern code
- Logical operation
- Fast Fourier Transforms (FFT)
- Repackaging for shipment
- Factory settings

Horizontal Axis Scaling

The horizontal axis scaling uses linear interpolation.

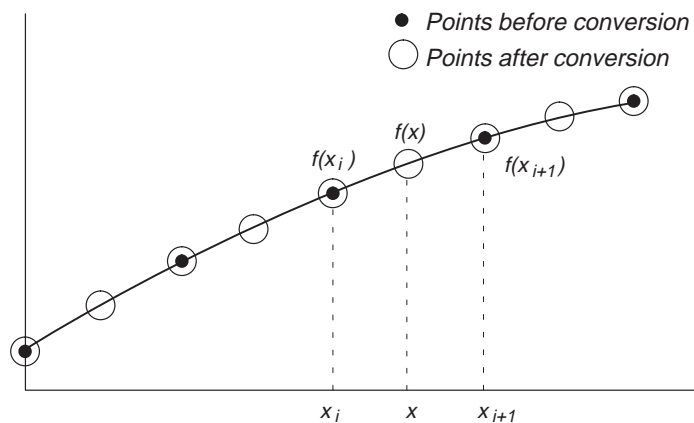

Figure D-1: Linear Interpolation

Here is the equation for linear interpolation.

$$f(x) = \frac{x-x_i}{x_{i+1}-x_i} \{f(x_{i+1})-f(x_i)\} + f(x_i)$$

Here, i is the waveform point number; i takes integer values i = 1, 2, ..., n.

NOTE. The number of points can be increased or decreased, but the waveform may lose its characteristics when the number of points are decreased.

Example 1: 5 points padded to 9 points.

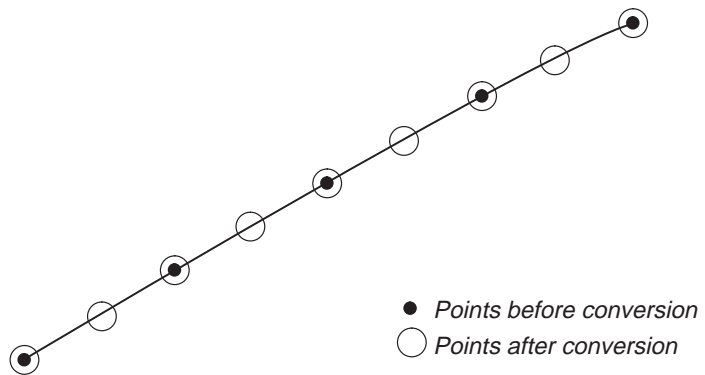

Figure D-2: Point Padding

Example 2: Reducing from 9 points to 6

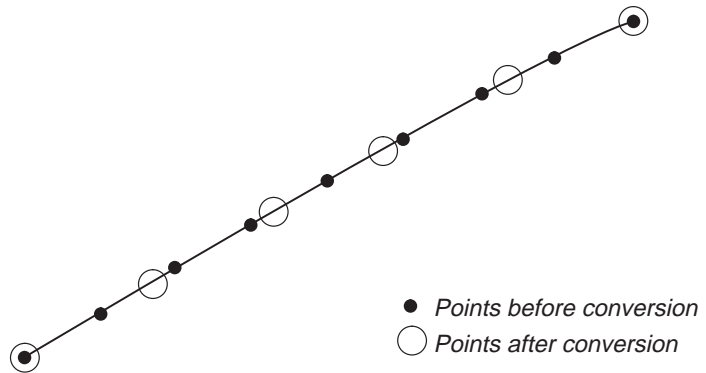

Figure D-3: Point Compression

Sampling Theorem

When the signal is continuous and the highest frequency component of the signal is f_0 , sampling with $T \leq 1/2f_0$ loses none of the data contained in the signal. T is the sampling interval. This theorem is well known as the sampling theorem. If data is created to meet this theorem, the necessary signal can be obtained.

$$X(t) = \sum_{n=-\infty}^{\infty} X(nT) \frac{\sin\{(2\pi/T)(t-nT/2)\}}{(2\pi/T)(t-nT/2)}$$

A continuous analog signal $x(t)$ can be reproduced from the digital data with the above equation.

Differentiation

The $\text{diff}()$ function calculates the central deviation as the differential value. The equation below expresses the central deviation when the function $f(x)$ is given at even intervals of Δx .

$$f'(x) \equiv \frac{f(x + \Delta x) - f(x - \Delta x)}{2 \Delta x}$$

In actual practice, when function $f(x)$ is expressed by n values, the differential value $f'(x_i)$ at point x_i is given by the following equation.

$$f'(x_i) \equiv n \frac{\{f(x_{i+1}) - f(x_{i-1})\}}{2}$$

Here, "n" is the number of waveform points and "i" is an integer in the range, $i = 1, 2, \dots, n$.

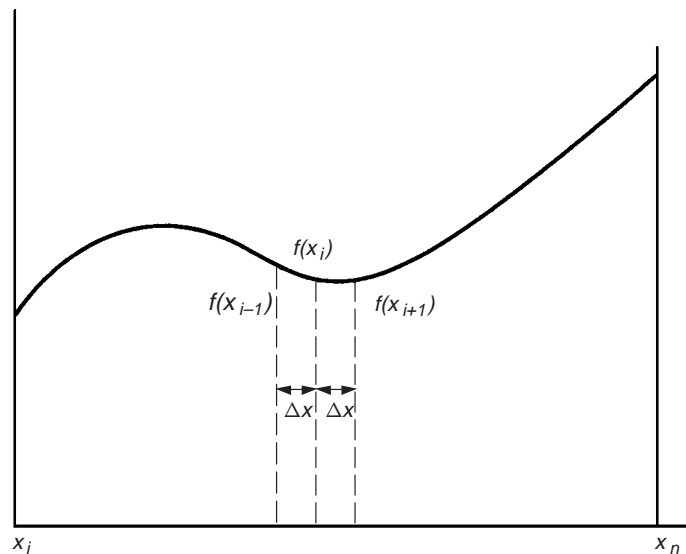

Figure D-4: Equation Differentiation

The values at the first and last points are obtained not from the center deviation, but from the following equations:

First point

$$f'(x_1) \equiv \frac{n\{-3f(x_1) + 4f(x_2) - f(x_3)\}}{2}$$

Last point

$$f'(x_n) \equiv \frac{n\{f(x_{n-2}) - 4f(x_{n-1}) + 3f(x_n)\}}{2}$$

Integration

The integ() function integrates numerically based on a trapezoidal formula. The trapezoidal formula is expressed with the following equation.

$$\int f(x)dx \equiv \sum_{i=1}^n \frac{f(x_{i-1}) + f(x_i)}{2} \cdot \Delta x$$

$$= \Delta \frac{X}{2} \{f(x_1) + 2f(x_2) + 2f(x_3) + \dots + 2f(x_{n-1}) + f(x_n)\}$$

Here, n is the number of waveform points and i is an integer in the range, i = 1, 2, ..., n.

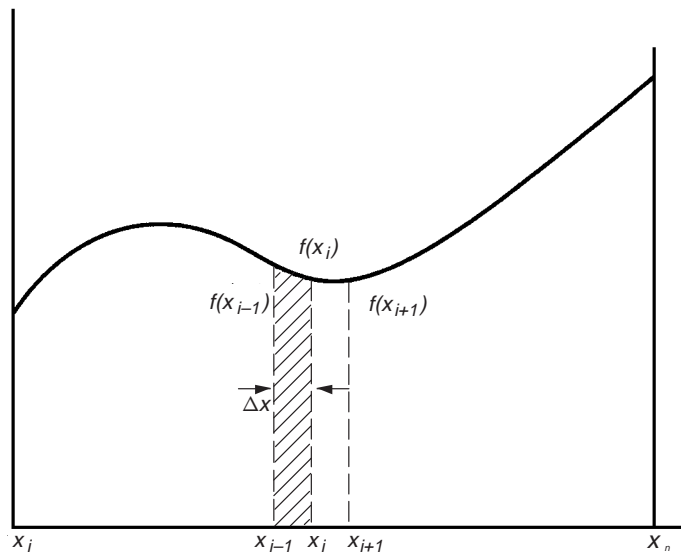

Figure D-5: Equation Integration

The integration is actually calculated with the following formula.

$$\int f(x)dx \equiv 1/2\{f(x_1) + 2f(x_2) + 2f(x_3) + \dots + 2f(x_{n-1}) + f(x_n)\}$$

However, the imaginary initial value $f(x_0)$ always takes a value of 0.

Random (rnd) Function

A random number generation algorithm uses an uniform distribution random generation routine and the central-limit theorem to derive Gaussian distribution random numbers.

Central-limit theorem: when the independent random variables $X_1, X_2, \dots,$ and X_n conform to an identical random distribution, the mean and variance of $x = (X_1 + X_2 + \dots + X_n)/n$ are given as follows:

$$E(n) = \mu \qquad V(n) = \sigma^2/n$$

Even if the initial random distribution is not normal, if a reasonably large value for n is used, the arithmetical mean x of a considerably large number of variables will be close to the normal distribution.

In actuality, 12 is used for n , uniform random numbers are accumulated n times and their arithmetical mean is derived as the ultimate Gaussian distribution random number.

The following algorithm is used to generate uniform distribution random numbers:

$$seed [n] = (253.0 \times seed [n-1] + 1.0) \text{ mod } 16777216$$

$$ran = seed [n] / 16777216$$

Pattern Codes

On the AWG2041, it is possible to select the coding system used when pattern strings are output. If the code will be affected by the immediately preceding data, the data item just before the first item of data will be calculated as 0. The following tables show the coding systems.

- **NRZ:** Normal data format

Pattern	Output Data
0	0
1	1

Example

Input	0	1	0	0	1	1	0	0	0	1	1	1
Output	0	1	0	0	1	1	0	0	0	1	1	1

- **NRZI:** The data changes when a 1 is received.

Each pattern is made up of 2 data items.

Example

Input	0	1	0	0	1	1	0	0	0	1	1	1
Output	00	01	11	11	10	01	11	11	11	10	01	10

- **RZ:** The data always returns to 0.

Each pattern is made up of 2 data items.

Pattern	Output Data
0	00
1	10

Example

Input	0	1	0	0	1	1	0	0	0	1	1	1
Output	00	10	00	00	10	10	00	00	00	10	10	10

- **MFM (Modified FM):** Each pattern is made up of 2 data items. In the table below, data in parentheses () indicates the immediately preceding data of the data for which coding is being attempted. Here the output data is inverted every time when 1 appears in the codes.

Pattern	Code Conversion
1	01
(0)0	10
(1)0	00

Example

Input	0	1	0	0	1	1	0	0	0	1	1	1
Code Conversion	10	01	00	10	01	01	00	10	10	01	01	01
Output	11	10	00	11	10	01	11	00	11	10	01	10

- **BI-PHASE:** Each pattern is made up of 2 data items.

Pattern	Output Data
0	01
1	10

Example

Input	0	1	0	0	1	1	0	0	0	1	1	1
Output	01	10	01	01	10	10	01	01	01	10	10	10

- **f/2f:** Each pattern is made up of 2 data items. In the table below, data in parentheses () indicates the immediately preceding data of the data for which coding is being attempted.

Pattern	Output Data
(0) 0	11
(1) 0	00
(0) 1	10
(1) 1	01

Example

Input	0	1	0	0	1	1	0	0	0	1	1	1
Output	11	01	00	11	01	01	00	11	00	10	10	10

- 1-7 RLL (Run-length Limited Codes):** 2-item patterns are made up of 3 data items, and 4-item patterns are made up of 6 data items. In the table below, x indicates that this value will become 1 when the preceding bit is 0, and 0 when the preceding bit is 1. Here the output data is inverted every time when 1 appears in the codes.

Pattern	Code Conversion
01	010
10	x00
11	x01
0001	x00000
0010	x00001
0011	010001
0000	010000

Example

Input	01	10	11	0010	10	0011	11	0001	0011	10	0000
Code Conversion	010	100	101	000001	000	010001	001	000000	010001	000	010000
Output	011	000	110	000001	111	100001	110	000000	011110	000	011111

- 2-7 RLL:** 2-item patterns are made up of 4 data items, 3-items pattern are made up of 6 data items and 4-item patterns are made up of 8 data items. Here the output data is inverted every time when 1 appears in the codes.

Pattern	Code Conversion
11	1000
10	0100
011	001000
010	100100
000	000100
0011	00001000
0010	00100100

Example

Input	11	10	010	000	0010	011	0011	10	0010
Code Conversion	1000	0100	100100	000100	00100100	001000	00001000	0100	00100100
Output	1111	1000	111000	000111	11000111	110000	00001111	1000	00111000

- user defined:** When user defined has been selected as the code for pattern setting from the **Code** selection menu, the following pattern systems can be created by setting the values for **Source Data Pattern**, **Converted Code**, **Initial Src**, **Initial Code** and **Out[1/0]**.

NRZ

Initial Sr **0**
Initial Code **0**
Out[1/0] **High/Low**

Source Data Pattern	Converted Code
0	0
1	1

NRZ1

Initial Sr **0**
Initial Code **0**
Out[1/0] **Invert/Keep**

Source Data Pattern	Converted Code
0	00
1	01

RZ

Initial Sr **0**
Initial Code **0**
Out[1/0] **High/Low**

Source Data Pattern	Converted Code
0	00
1	10

BIPHASE

Initial Sr **0**
Initial Code **0**
Out[1/0] **High/Low**

Source Data Pattern	Converted Code
0	01
1	10

f/2f

Initial Sr 0
 Initial Code 0
 Out[1/0] Invert/Keep

Source Data Pattern	Converted Code
0	10
1	11

MFM

Initial Sr 0
 Initial Code 0
 Out[1/0] Invert/Keep

Source Data Pattern	Converted Code
0	30
1	01

Logical Operation

In the waveform editor timing display, it is possible to perform logical operations for data on different data lines. The following logical tables and timing charts show examples of each type of operations.

■ **AND**

A	B	A*B
0	0	0
0	1	0
1	0	0
1	1	1

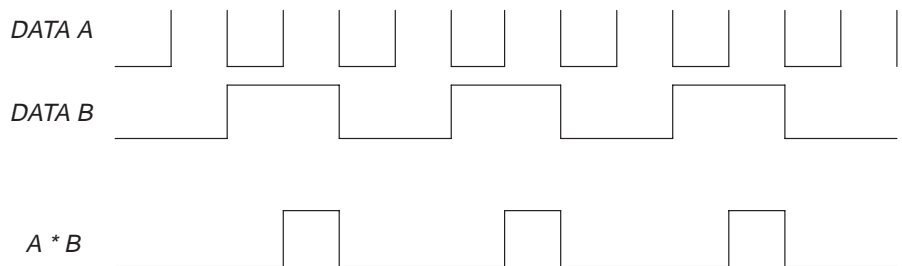

■ **NAND**

A	B	$\overline{A \cdot B}$
0	0	1
0	1	1
1	0	1
1	1	0

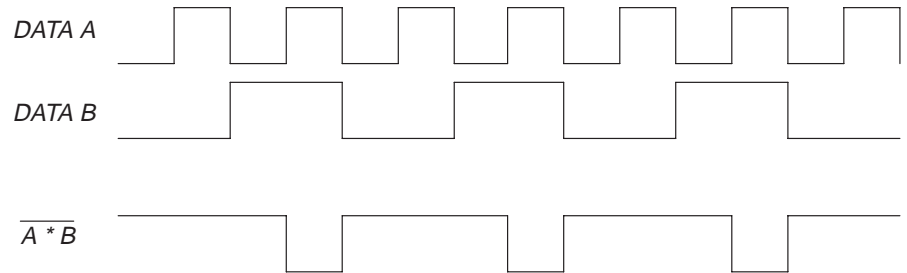

■ OR

A	B	$A + B$
0	0	0
0	1	1
1	0	1
1	1	1

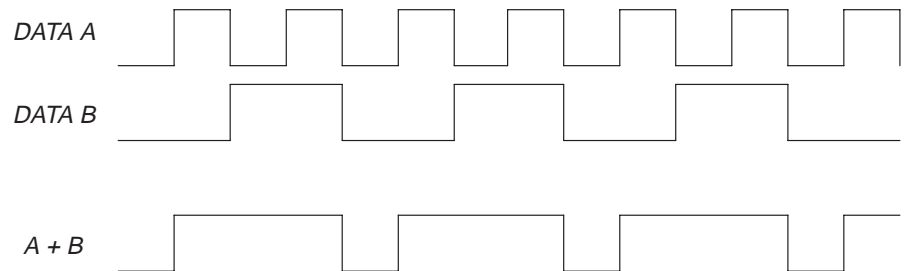

■ NOR

A	B	$\overline{A + B}$
0	0	1
0	1	0
1	0	0
1	1	0

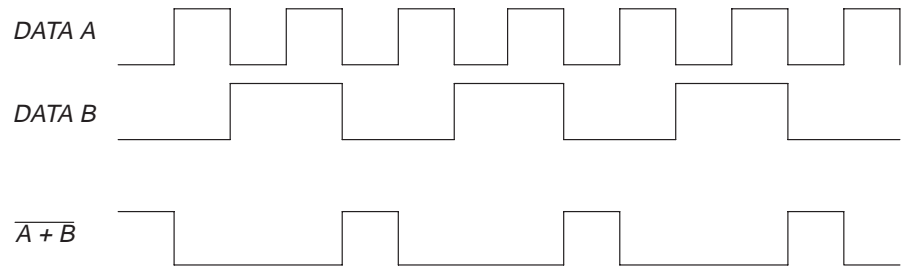

■ EX-OR

A	B	$A \oplus B$
0	0	0
0	1	1
1	0	1
1	1	0

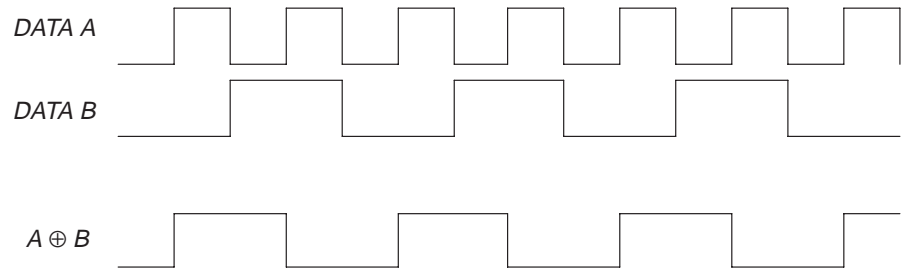

■ EX-NOR

A	B	$\overline{A \oplus B}$
0	0	1
0	1	0
1	0	0
1	1	1

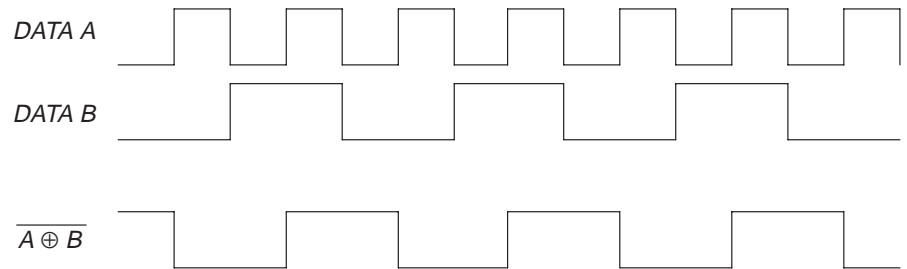

FFT (Fast Fourier Transforms)

FFT is an algorithm for fast calculation of discrete Fourier transform. FFT transforms the time axis signal onto the frequency axis. FFT can also provide the frequency component magnitudes and phases. With the FFT editor, you can use inverse FFT (IFFT) to generate the real time data from the frequency component magnitudes and phases.

Basic FFT Rules

FFT discrete Fourier transforms any number of sample points, but certain rules must be followed.

- 1) The Record Length must be a Power of 2.

The FFT calculations can only be used when the record length is an power of 2 (2, 4, 8, ... 2^n). The minimum record length for the this instrument is 512 points, and the maximum record length is 16384 points.

If the record length is not a power of 2, the waveform is edited expanded to a power of 2. Then when the editing is complete and the waveform is saved, the waveform is reduced to its original record length by interpolating the data. Therefore, it is recommended to use the record length of a power of 2 when accurate data is needed.

- 2) Nyquist Frequency and Aliasing

FFT transforms the sampled data on the time axis into data on the discrete frequency axis from 0 Hz to the maximum permitted frequency. The maximum permitted frequency is called the Nyquist frequency and is 1/2 the sampling rate.

If the signal has frequency components above the Nyquist frequency, they appear on this limited discrete frequency axis too. They appear as no different than noise aliased from the Nyquist frequency. For example, if there is a signal 5 MHz above the Nyquist frequency, it appears as if it is 5 MHz below the Nyquist frequency. On the other hand, in the D/A conversion, a frequency component is output aliased above the Nyquist frequency.

To deal with aliasing, first it is necessary to sample with a clock greater than double the highest frequency component in the signal. Second, a low-pass filter is required to block any signal above the Nyquist frequency.

Record Length and Frequency Resolution

The frequency spectrum frequency range and resolution depend on the time axis sampling rate and the record length (N).

For the given data length on the time axis, FFT has frequency components from $-N/2$ to $N/2-1$. However, when the real number data on the time axis is transformed, FFT gives results symmetrical about 0 Hz (DC). Because of this symmetry, all the necessary frequency data is contained between 0 and $N/2 - 1$. Thus, with FFT if values are given from zero to the positive $N/2$ point, this is enough. Since the non-DC components have energy dispersed on both the positive and negative sides, the DC component is 2x the other components. Since the DC component is scaled by 1/2 with the FFT editor, DC and the other components can be handled equally.

Since FFT has $N/2$ sampling points on the discrete frequency axis between DC and the Nyquist frequency (F_N), the frequency resolution is $F_N / (N/2)$. Since the Nyquist frequency is one half the sampling rate (f_s), the frequency resolution can also be expressed as f_s / N .

Therefore, if the sampling rate is fixed, when the record length is increased, the frequency resolution rises. On the other hand, if the record length is fixed, raising the sampling rate raises the Nyquist frequency and lowers the frequency resolution.

Relationship Between Phase and Delay

The phase is the quantitative displacement from the standard time. The $\cos(2\pi ft)$ has a 0 phase, but $\sin(2\pi ft)$ has a 90 degree delay. The standard time is the sampling start time.

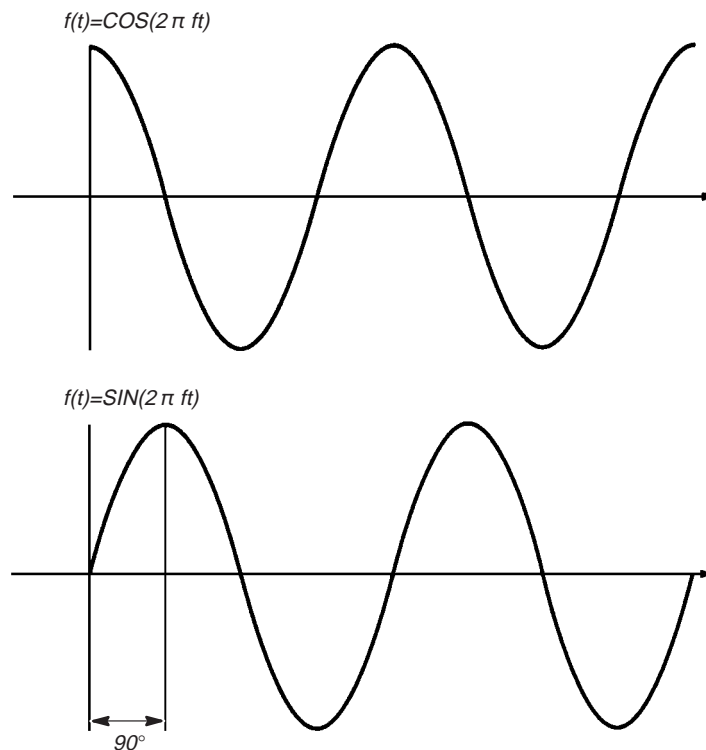

Figure D-6: Phase and Delay

FFT Window Functions

FFT calculates with limited data blocks. Also, since FFT calculations assume that the sampled data blocks are repeated infinitely, frequency error arises from non-continuities generated at the edges of data blocks. This frequency error is called leakage error.

The leakage error depends on the FFT window function selected. The processing to bring the window function at both ends towards 0 in order to give the FFT continuity is called taper processing. This instrument has the square wave window, which does not apply taper processing to the time region data, and five FFT window functions that do carry out taper processing.

The FFT window functions in the time region correspond to filters in the frequency region. This is convolution and it is well known that it has a characteristic of $\sin(x)/x$ for square window. These filters have a high lobe at the center, in other words a transmitting band width,. This lobe determines how great the neighboring frequency components can be separated.

The transmission amount for the side lobes neighboring this center lobe determines the amount of leakage. Leakage is the spread of energy from a certain frequency component for the displayed frequency spectrum. Frequency components with small magnitudes are covered overall by leakage.

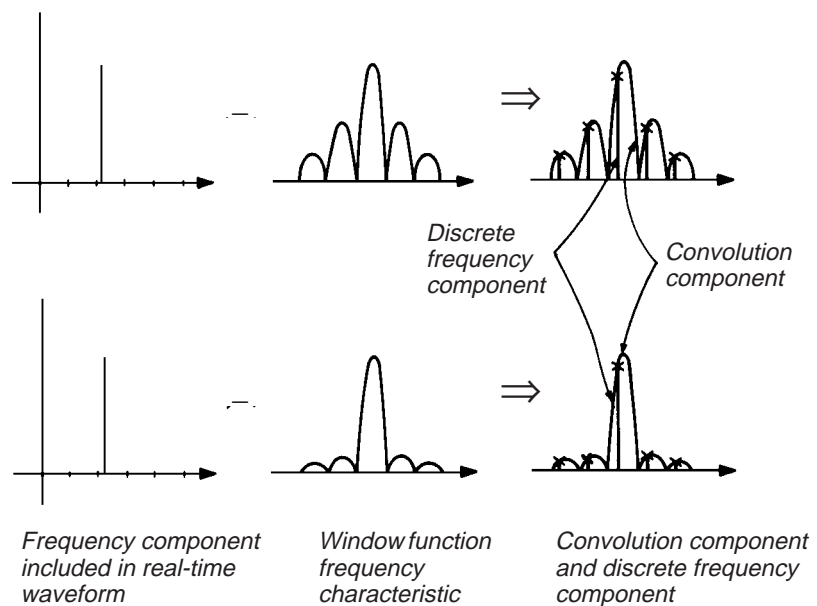

Figure D-7: Concept of Convolution

Figures D-8 through D-13 show the FFT window functions prepared for this instrument and their characteristics. Also, note that if you use a window function with taper processing, then carry out inverse Fourier transformation to make real-time data, that real-time data is tapered.

The window functions are effective for investigating the frequency components of the acquired waveform, but the waveform after the window function is applied differs from the original waveform.

Square Wave Window — The square wave window does not taper the time region data. The filter shape in the frequency region is $\sin(x)/x$. The square wave window is appropriate for observing the frequency spectrum of non-repetitive signals. The square wave window is also used for observing frequency components near DC.

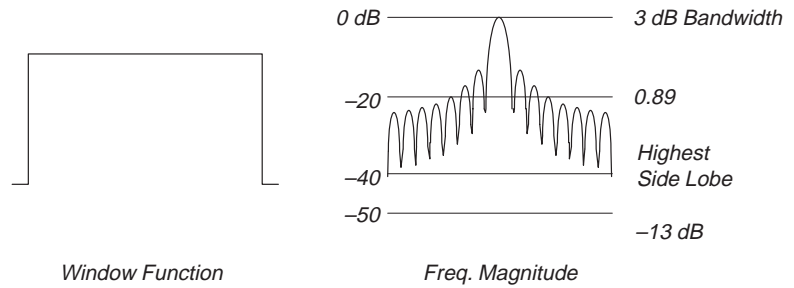

Figure D-8: Square Window and Frequency Characteristic

Hanning Window — The Hanning window is a function derived from the cos function. This window function has superior magnitude precision and leakage elimination characteristics.

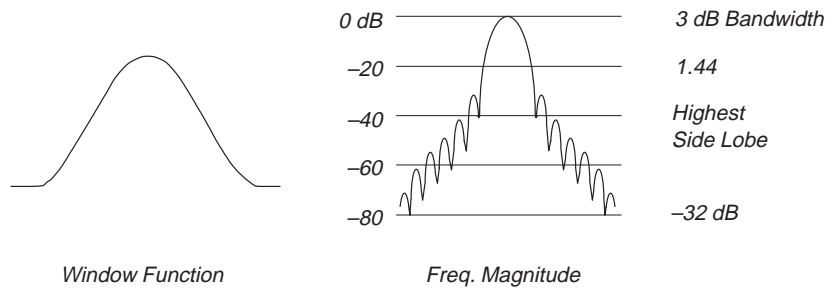

Figure D-9: Hanning Window and Frequency Characteristic

Hamming Window — The hamming window is similar to a hanning window, but it suppresses more the transmissivity for the side lobes next to the transmitting bandwidth. Compared to FFT processing using a hanning window, the degree of separation between two frequencies is greater, as can be seen in Figure D-10. This window is particularly effective for separating close frequencies.

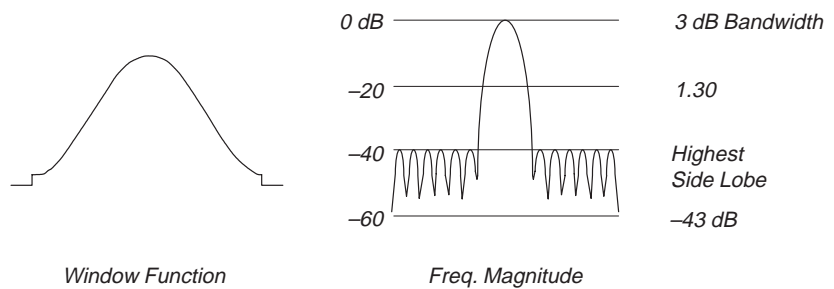

Figure D-10: Hamming Window and Frequency Characteristic

Blackman-Harris Window — Of the six window functions in this instrument, the Blackman-Harris window has the broadest transmission bandwidth (and therefore, lowest frequency resolution) and the lowest side lobe transmission (and therefore, lowest leakage). This window is particularly suited for observing wide range frequency spectra.

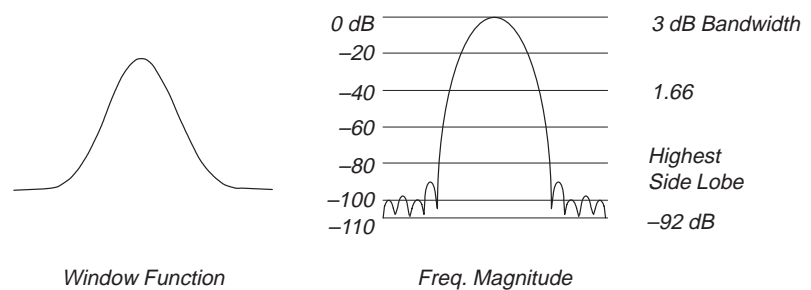

Figure D-11: Blackman-Harris Window and Frequency Characteristic

Blackman Window — The Blackman window suppresses the side lobe magnitudes in the frequency region lower than the hamming window does and suppresses leakage even farther. However, it has inferior frequency resolution.

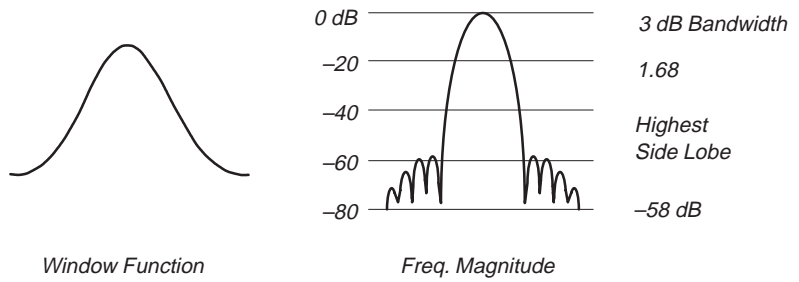

Figure D-12: Blackman Window and Frequency Characteristic

Triangle Wave Window — The triangle wave window is a convolution of two square windows half the width of the window. Therefore, the triangle wave window frequency spectrum is the product of the square wave windows.

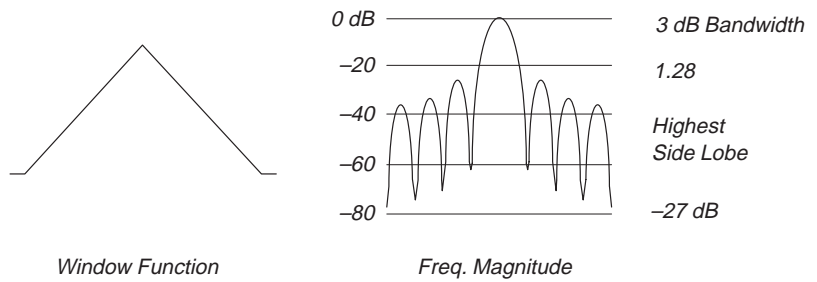

Figure D-13: Triangle Window and Frequency Characteristic

Repackaging for Shipment

If this instrument is shipped by commercial transportation, use the original packaging material. Unpack the instrument carefully from the shipping container to save the carton and packaging material for this purpose.

If the original packaging is unfit for use or is not available, repackage the instrument as follows:

- Step 1:** Obtain a corrugated cardboard shipping carton having inside dimensions at least six inches greater than the instrument dimensions and having a carton test strength of at least 275 pounds.
- Step 2:** If the instrument is being shipped to a Tektronix Service Center for repair or calibration, attach a tag to the instrument showing the following: owner of the instrument (with address), the name of a person at your firm who may be contacted if additional information is needed, complete instrument type and serial number, and a description of the service required.
- Step 3:** Wrap the instrument with polyethylene sheeting or equivalent to protect the outside finish and prevent entry of packing materials into the instrument.
- Step 4:** Cushion the instrument on all sides by tightly packing dunnage or urethane foam between the carton and the instrument, allowing for three inches of padding on each side (including top and bottom).
- Step 5:** Seal the carton with shipping tape or with an industrial stapler.
- Step 6:** Mark the address of the Tektronix Service Center and your return address on the carton in one or more prominent locations.

Factory Settings

When **Reset to Factory** is selected from the **UTILITY Misc** menu, this instrument's parameters are reset to the values they had at the factory. Table D-1 lists these factory settings.

Table D-1: Factory Settings

Setup Menu	
Clock Frequency	1.000 000 GHz
Clock Source	Internal
Filter	Through
Amplitude	1.000 V
Offset	0.000 V
Marker 1, Marker 2	High : 2.0 V, Low : 0.0 V
Display	Graphics
MODE Menu	
Operating mode	Cont
Triggered Slope	Positive
Gated Polarity	Positive
Level	1.4V
Impedance	1 k Ω
Autostep Run	Continuous
Burst Count	1
LOAD/SAVE Menu	
Device	Disk
Auto Load	Off
UTILITY Menu	
Misc Display... Brightness	70%
Misc Display... Catalog Order	Name1
Misc Display... Data Time	Off
Misc Config... Change Sequencer Mode	On
Misc Hardcopy... Format	BMP
Misc Hardcopy... Port	Disk
Diag/Cal Diagnostics	All
Diag/Cal Calibrations	All

Table D-1: Factory Settings (Cont)

FG Menu	
Function waveform Selection	Sine
Frequency	10.000 00 MHz
Amplitude	1.000V
Offset	0.000V
Polarity	Normal
Pulse Duty	50%

The following **UTILITY** menu settings are not affected by **Reset to Factory**.

Remote Port

GPIB Address

GPIB operating mode

Setting the RS-232-C parameters

Date/Time

Appendix E: Performance Verification Procedure

This subsection describes the verification procedures in this section, indicates when to use the procedures, and gives conventions used in their structure. The procedures in this section are:

- Self Tests
- Performance Tests

Preparation

These procedures verify the AWG2041 Arbitrary Waveform Generator functionality. Which procedure to do depends on your goal:

- To quickly confirm that the AWG2041 functions correctly and was adjusted properly, do the procedures under *Self Tests*, which begin on page E-3.

Advantages: These procedures are short, require no external equipment, and perform extensive functional and accuracy testing. Use them to quickly determine if the AWG2041 is suitable for putting into service, such as when it is first received.

- For a more extensive confirmation of performance, do the *Performance Tests*, beginning on page E-7 after doing the *Self Tests*.

Advantages: These procedures involve direct checking of warranted specifications. They require more time and suitable test equipment. (See *Equipment Required* on page E-8.)

Before starting any of these procedures, read *Overview* and *Basic Menu Operation* in section 2 of this manual. These instructions describe the AWG2041 front-panel controls and menu system.

Conventions

Throughout the procedures in this section, the following conventions apply:

- Each test procedure uses the following general format:
 - Title of Test
 - Equipment Required
 - Prerequisites
 - Procedure

- Each procedure consists of as many steps, substeps, and subparts as required to do the test. Steps, substeps, and subparts are sequenced as follows:
 1. First Step
 - a. First Substep
 - First Subpart
 - Second Subpart
 - b. Second Substep
 2. Second Step
- Instructions for menu selection follow this format: **FRONT PANEL BUTTON→Main Menu Button→Side Menu Button**. For example, “Press **UTILITY→Misc→Config...→Reset to Factory→O.K.**”
- Where instructed to use a front-panel button, key, or knob, or select from the MENU column, or from a bottom or side menu, the name of the item appears in boldface type: “push **MODE,**” or “select **Triggered** in the bottom menu.”

Self Tests

This subsection describes how to use AWG2041 internal self-test routines. No equipment is required to do these procedures. The self tests include these internal routines:

- **Diagnostics**

This self-test procedure uses internal routines to verify that the AWG2041 functions, and passes the internal circuit tests.

- **Calibration**

The second procedure checks the AWG2041 internal calibration constants and changes them if needed.

Diagnostics

The internal diagnostic routines check AWG2041 characteristics such as amplitude, offset, trigger level, clock, filters and attenuation.

The AWG2041 automatically performs the internal diagnostics at power-on; you can also run the internal diagnostics using the menu selections described in this procedure. The difference between these two methods of initiating the diagnostics is that the menu method does more detailed memory checking than the power-on method.

Equipment Required: None.

Prerequisites: Power on the AWG2041 and allow a twenty-minute warmup period before doing this procedure.

Procedure:

1. *Verify that internal diagnostics pass:* Do the following substeps to verify passing internal diagnostics.
 - a. *Display the diagnostics menu and select all tests:* Push **UTILITY**→**Diag/Cal**→**Diagnostics xxxx**→**All**. See the menu in Figure E-1.

The list on the left shows the tests available for diagnostics. In addition to selecting all of the tests shown for diagnostics, you can select only the test(s) you want to run using the general purpose knob. In Figure E-1, the symbol to the left of **Cpu** indicates that test is one of the tests selected. The Interactive Test area is reserved for manufacturing at the factory.

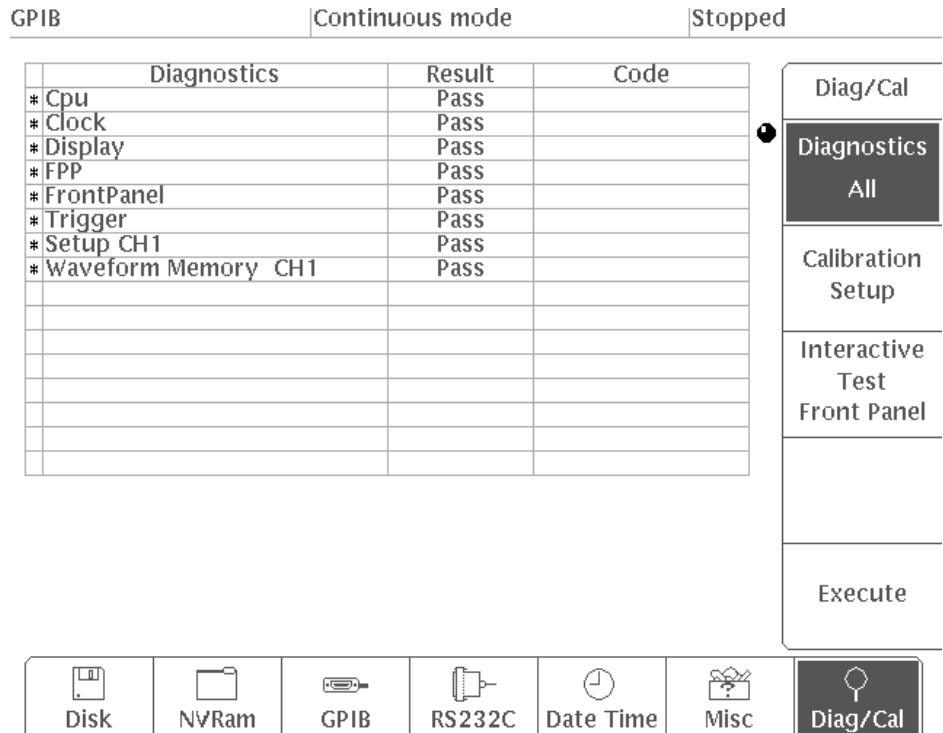

Figure E-1: Diagnostics Menu

- b. *Run the diagnostics:* Select **Execute** from the side menu. This executes all the AWG2041 diagnostics automatically.
 - c. *Wait:* The internal diagnostics do an extensive verification of AWG2041 functions. While this verification progresses, the screen displays the clock icon. When finished, the resulting status appears on the screen.
 - d. *Confirm that no failures are found:* Verify that no failures are found and reported on-screen. If the diagnostics displays **FAIL** as the result of any test, consult a qualified service technician for further assistance.
2. *Return to regular service:* Push a button (other than **UTILITY**) in the **MENU** column to exit the diagnostic menu.

NOTE. The interactive tests on the Diagnostics screen are for manufacturing use at the factory.

Calibration

The AWG2041 includes internal calibration routines that check electrical characteristics such as amplitude, offset and attenuation and adjust internal calibration constants as necessary. This procedure describes how to do the internal calibration.

Equipment Required: None.

Prerequisites: Power on the AWG2041 and allow a 20 minute warmup period at an ambient temperature between +20° C and +30° C before doing this procedure.

Procedure:

1. *Verify that internal adjustments pass:* Do the following substeps to verify passing of internal adjustments.
 - a. *Display the calibration menu:* Push **UTILITY**→**Diag/Cal**→**Calibration**. See the menu in Figure E-2.

The list on the left shows the tests available for calibration. You can select only the **Setup CH1** test.

GPIB		Continuous mode		Stopped	
	Calibration	Result	Code		
*	Setup CH1	Pass		Diag/Cal	
				Diagnostics All	
				Calibration Setup	
				Interactive Test Front Panel	
				Execute	
				Diag/Cal	

Figure E-2: Calibration Menu

- b. *Run the adjustments routine:* Select **Execute** from the side menu. This executes the AWG2041 calibration routines automatically.
 - c. *Wait:* The internal calibration does an exhaustive verification of proper AWG2041 function. While this verification progresses, the clock icon appears on screen. When finished, the resulting status will appear on the screen.
 - d. *Confirm that no failures are found:* Verify that no failures are found and reported on-screen. If the calibration displays **FAIL** as the result, consult a qualified service technician for further assistance.
2. *Return to regular service:* Push any button (other than **UTILITY**) in the **MENU** column to exit the calibration menu.

NOTE. *When the AWG2041 is powered off while the calibrations is executed, the calibration data in the memory may be loss.*

Performance Tests

This subsection contains a series of procedures for checking that the AWG2041 Arbitrary Waveform Generator performs as warranted.

The procedures are arranged in nine logical groupings, presented in the following order:

- Operating Mode Checks
- Clock Frequency Check
- Amplitude and Offset Accuracy Checks
- Pulse Response Checks
- Sine Wave Checks
- AUX Output Checks
- External Trigger Input Checks
- External CLOCK IN Check
- Digital Data Out Checks

These procedures extend the confidence level provided by the internal diagnostic and calibration routines described on page E-5.

Prerequisites

The tests in this subsection comprise an extensive, valid confirmation of performance and functionality, when the following requirements are met:

- You must have performed and passed the calibration procedure described in *Self Tests*, the previous subsection.
- The AWG2041 must have passed the calibration procedure mentioned above or must have been adjusted using the adjustment procedure in section 5 in the AWG2041 Service manual at an ambient temperature between +20° C and +30° C, must have been operating for a warm-up period of at least 20 minutes, and must be operating at an ambient temperature between 10° C and +40° C.

NOTE. For operation to specified accuracy, allow the AWG2041 to warm up at least 20 minutes before doing the performance tests.

- Load all the files from the Performance Check/Adjustment disk (063-1915-XX) that is provided as a standard accessory into AWG2041 internal memory. For instructions on loading files, see *Loading Files* on page E-10.

Related Information

Read *Preparation and Conventions* on page E-1. Also, if you are not familiar with operating the AWG2041, refer to *Instructions for Operation* before doing any of these procedures.

Equipment Required

The following equipment is required to check the performance of the AWG2041.

Table E-1: Test Equipment

Item Description	Minimum Requirements	Example	Purpose
Precision termination	Impedance: 50 Ω , 0.1% Connectors: BNC	Tektronix Part 011-0129-XX	Signal termination.
Adapter	Connectors: BNC female-to-dual banana	Tektronix Part 103-0090-XX	Signal interconnection.
Adapter	Connectors: BNC female-to-N male	Tektronix Part 103-0045-XX	Signal interconnection.
BNC dual input (TEE) adapter	Connectors: BNC	Tektronix Part 103-0030-XX	Signal interconnection.
DC Block	Impedance: 50 Ω Frequency: 10 kHz to 21 GHz Connectors: N male-to-female	Tektronix Part 015-0509-XX	DC block.
BNC cable (3 required)	Impedance 50 Ω Connectors: BNC Length: 43 inches	Tektronix Part 012-0057-XX	Signal interconnection.
SMB cable (2 required)	Impedance 50 Ω Connectors: SMB Length: 100 cm	Tektronix Part 012-1458-XX	Signal interconnection.
SMB-BNC cable (2 required)	Impedance 50 Ω Connectors: SMB to BNC Length: 100 cm	Tektronix Part 012-1459-XX	Signal interconnection.
Test oscilloscope	Bandwidth: >500 MHz	Tektronix TDS500 Series Digitizing Oscilloscope	Checks output signals. Used in many procedures.
Spectrum analyzer	Frequency range: to 1.8 GHz Dynamic range: 80 dB	Tektronix 497P or 2712	Checks output signals.
Frequency counter	Frequency range: 1 MHz to 100 MHz Accuracy: <0.2 ppm	Anritsu MF1601A* ¹	Used to check clock frequency.
Digital multimeter	DC volts range: 0.05 V to 10 V Accuracy: $\pm 0.1\%$	Fluke 8842A	Used throughout the checks to measure voltage.

Table E-1: Test Equipment (Cont.)

Item Description	Minimum Requirements	Example	Purpose
Function generator	Output voltage: –7 V to 7 V	Tektronix AFG 2020 Function Generator* ²	Used to input the trigger signal.
RF signal generator	Frequency range: 245 MHz to 1040 MHz	Rohde & Schwarz SMY01* ³	Used to input the external clock signal.
Performance Check disk	Must use example listed	Tektronix Part 063-1915-XX	Used throughout the checks to provide waveform files.

Table E-2: Additional Test Equipment for Optional Check (Slave Mode)

Item Description	Minimum Requirements	Example	Purpose
Waveform generator	Must use example equipment (Optional test)	Tektronix AWG2041 Arbitrary Waveform Generator	Checks Slave mode and Master clock Test

Table E-3: Additional Test Equipment for Option 03

Item Description	Minimum Requirements	Example	Purpose
ECL termination	Frequency: DC to 10 GHz	Tektronix Part 015-0558-XX	Used to check digital data output
Adapter	Connectors: BNC male-to-SMA female	Tektronix Part 015-0572-XX	Used to check digital data output
Adapter	Connectors: SMA male-to-SMA male	Tektronix Part 015-1011-XX	Used to check digital data output
Adapter	Connectors: SMA female-to-SMA female	Tektronix Part 015-1012-XX	Used to check digital data output
Adapter	Connectors: BNC female-to-SMA male	Tektronix Part 015-1018-XX	Used to check digital data output
DC power supply	Output voltage: –2.45 V	Tektronix PS 280 or PS283 DC Power Supply* ⁴	Used to check digital data output

If available, item *1, *2, *3 and *4 can be replaced by a Tektronix DC5010, FG5010, SG504 and PS5010. (A TM5000 Series Module Mainframe is required.)

Loading Files

The following steps explain how to load files from the Performance Check/Adjustment disk (063-1915-XX) into internal memory.

1. Push the **LOAD/SAVE** button in the **MENU** column.
2. Turn the disk so the side with the arrow is on top; insert the disk into the AWG2041 floppy disk drive.
3. Push the **Device** button along the bottom menu to select **Disk**. The menu in Figure E-3 appears.
4. Select the **Load All** button along the side menu to load all files in the root directory on the disk into the AWG2041 internal (volatile) memory. Or, turn the general-purpose knob to highlight the file you want to load and select **Load**. The display indicates which file it is loading. When loading is complete, the clock icon disappears.
5. Push the floppy drive button and remove the disk from the floppy drive.
6. Push any button in the **MENU** column (other than **LOAD/SAVE**) to exit the menu.

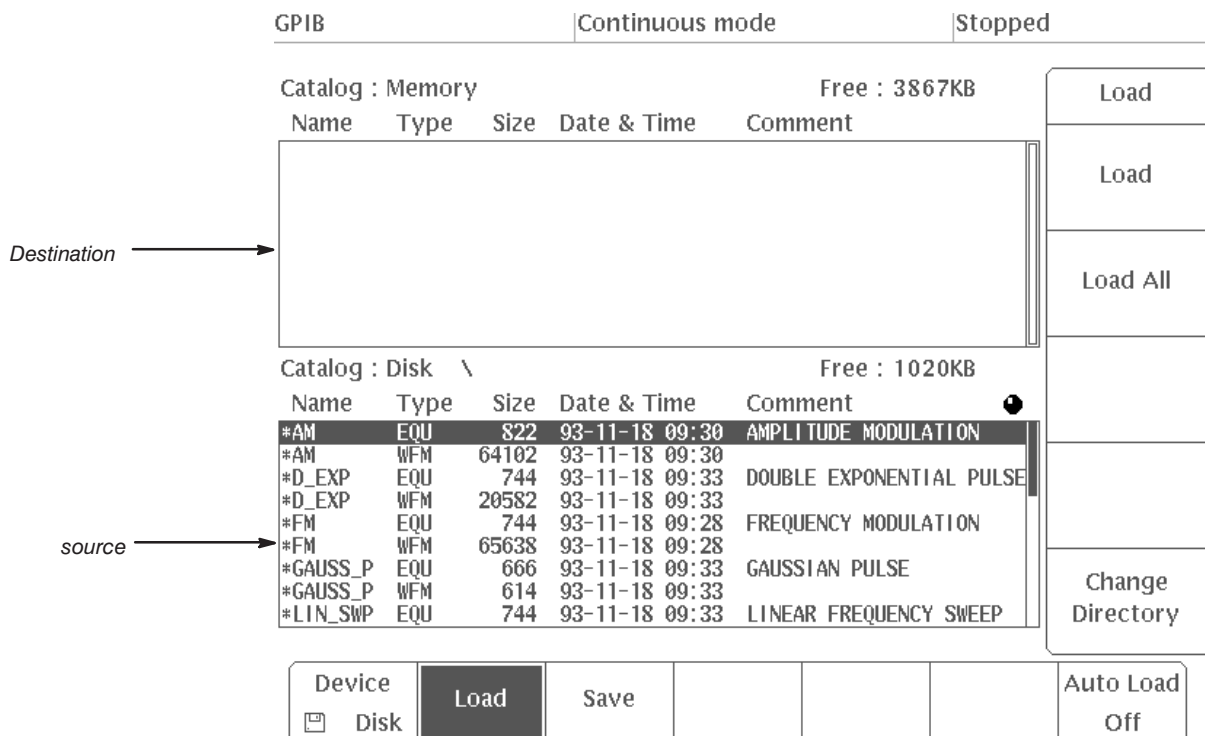

Figure E-3: LOAD Menu

Performance Check/Adjustment Files

Table E-4 lists the waveform files on the Performance Check/Adjustment disk (063-1915-XX) that are used in these performance tests, the AWG2041 front-panel settings that each file sets up, and the performance test that uses each file.

NOTE. The files on the Performance Check disk are locked (the files names are displayed with *), so the data in these files cannot be changed unless the lock is opened. The file data includes not only waveform data, but also output parameters.

When you select a file with the **Waveform Sequence** item, the AWG2041 output parameters change to those specified in the file, and the waveform output reflects waveform data in the file. After selecting a file, do not change an output parameter with the **SETUP** menu unless a procedure instructs you to do so. During the procedures, if you are unsure that the AWG2041 settings still match the file's settings, select the waveform again using the **Waveform Sequence** item on the **SETUP** menu.

Table E-4: File List for Performance Check/Adjustment Disk







No.	File Name	EDIT Menu		SETUP Menu				Marker Setup	Usage
		Wfm Shape	Wfm Point	Clock	Filter	Ampl	Offset		
1	MODE.WFM		1024	1.024 GHz	Through	1 V	0 V		Cont Mode, Triggered Mode, Gated Mode, Burst Mode, Slave Mode
2	MODE_ADV.SEQ ADV-1.WFM		1024	1 MHz	Through	1 V	0 V		Waveform Advance Mode
	ADV-2.WFM		1024	1 MHz	Through	1 V	0 V		
3	MODE_AST.AST Step: 1 AST-1.WFM		1024	500 kHz	Through	1 V	0 V		Autostep Mode
	Step: 2 AST-2.WFM		1024	1 MHz	Through	1 V	0 V		
4	PULSE.WFM		1024	1 GHz	Through	1 V	0 V		Pulse Response

Table E-4: File List for Performance Check/Adjustment Disk (Cont.)

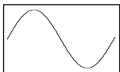
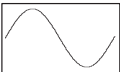
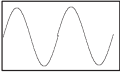
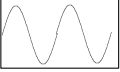
No.	File Name	EDIT Menu		SETUP Menu				Marker Setup	Usage
		Wfm Shape	Wfm Point	Clock	Filter	Ampl	Offset		
5	SINE.WFM		1024	1 GHz	Through	1 V	0 V		Sine Wave Characteristic
6	MARKER-L.WFM		1024	1 GHz	Through	1 V	0 V	Marker1,2: Low level	AUX Output
7	MARKER-H.WFM		1024	1 GHz	Through	1 V	0 V	Marker1,2: High level	AUX Output
8	MARKER.WFM		1024	1 GHz	Through	1 V	0 V	Marker1,2: Pulse, 1 Period Low: 512 points, 0 V High: 512 points, 2 V	AUX Output
9	TRIGGER.WFM		1024	1 GHz	Through	1 V	0 V	Marker1,2: Pulse, 1 Period Low: 1 point, 0 V High: 1023 points, 2 V	Trigger Input
10	DOUT.WFM		1024	100 MHz					Digital Data Output

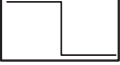
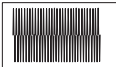
Operating Mode Checks

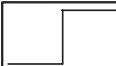
These procedures check operation of the Cont, Triggered, Gated, Burst, Waveform Advance, Autostep, and Slave modes. Slave mode are optional test.

Check Cont Mode

Electrical Characteristic Checked: Operating mode, Continuous, on page B-3.

Equipment Required: A 50 Ω coaxial cable and an oscilloscope.

Prerequisites: The AWG2041 must meet the prerequisites listed on page E-7.

Procedure:

1. *Install the test hookup and set test equipment controls:*
 - a. *Hook up the oscilloscope:* Connect the AWG2041 CH1 output connector through the coaxial cable to the CH1 vertical input connector on the oscilloscope (see Figure E-4).

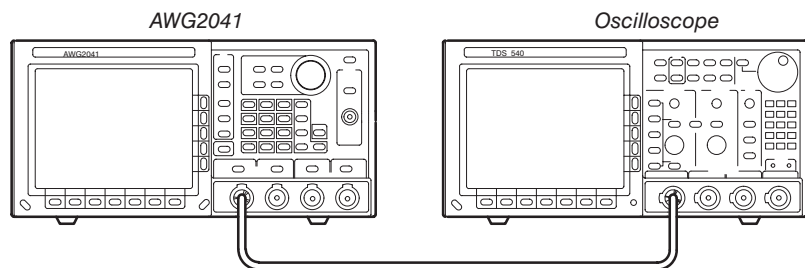

Figure E-4: Cont Mode Initial Test Hookup

- b. *Set the oscilloscope controls:*

Vertical	CH1
CH1 coupling	DC
CH1 scale	0.2 V/div.
CH1 input impedance	50 Ω
Horizontal	
Sweep	500 ns/div.

Trigger	
Source	CH1
Coupling	DC
Slope	Positive
Level	+100 mV
Mode	Auto

2. *Set the AWG2041 controls and select the waveform file:*
 - a. *Initialize AWG2041 controls:* Push **UTILITY**→**Misc**→**Config...**→**Reset to Factory**→**O.K.**
 - b. *Select the file:*
 - Push **SETUP**→**Waveform Sequence**.
 - Turn the general purpose knob to display the list of waveform files and highlight the **MODE.WFM** file.
 - Push **ENTER** to select the file. This button is located to the lower-right of the numeric keypad.
3. *Turn on the AWG2041 CH1 output:* Push the **CH1** button so that the LED above the CH1 output connector is on.
4. *Check against limits:* Check that the amplitude of the sine wave displayed on the oscilloscope is 5 vertical divisions and that 2 horizontal divisions of the waveform are displayed.
5. Repeat this procedure, connecting the oscilloscope to the AWG2041 CH1 output connector, and turning on the CH1 output.
6. *End procedure:* Disconnect the oscilloscope.

Check Triggered Mode

Electrical Characteristic Checked: Operating mode, Triggered, on page B-3.

Equipment Required: Two 50 Ω coaxial cables, a function generator, and an oscilloscope.

Prerequisites: The AWG2041 meets the prerequisites listed on page E-7.

Procedure:

1. *Install the test hookup and set test equipment controls:*
 - a. *Hook up the oscilloscope:* Connect the AWG2041 CH1 output connector through the coaxial cable to the CH1 vertical input connector on the oscilloscope.
 - b. *Hook up the function generator:*

- Connect the AWG2041 **TRIGGER INPUT** connector through a coaxial cable to the function generator output connector (see Figure E-5).

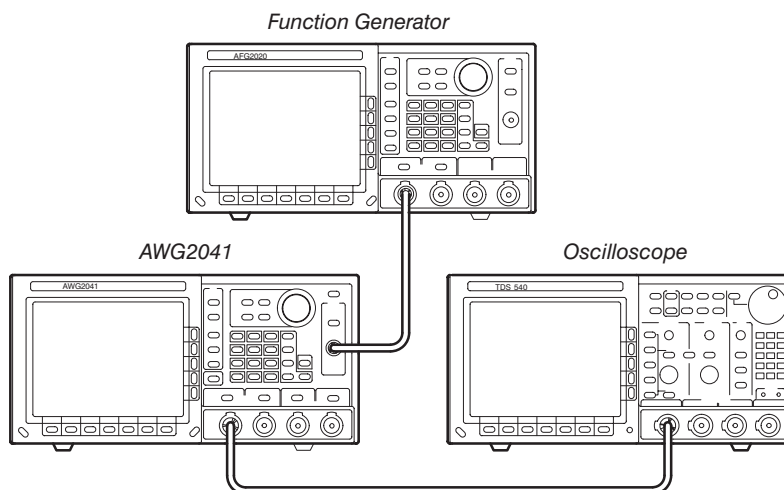

Figure E-5: Triggered Mode Initial Test Hookup

c. *Set the oscilloscope controls:*

Vertical	CH1
CH1 coupling	DC
CH1 scale	0.2 V/div.
CH1 input impedance	50 Ω
Horizontal	
Sweep	500 ns/div.
Trigger	
Source	CH1
Coupling	DC
Slope	Positive
Level	+100 mV
Mode	Auto

d. *Set the function generator (AFG2020) controls:*

Function	Square
Mode	Continuous
Parameter	
Frequency	100 kHz
Amplitude	2.0 V (4V into open circuit)
Offset	1.0 V (2V into open circuit)
Output	Off

2. *Set AWG2041 controls and select the waveform file:*

- a. *Initialize AWG2041 controls:* Push **UTILITY**→**Misc**→**Config...**→**Reset to Factory**→**O.K.**
- b. *Modify the AWG2041 default settings:*
 - Push **MODE**→**Triggered**→**Slope** to select Positive slope.
- c. *Select the file:*
 - Push **SETUP**→**Waveform Sequence**.
 - Highlight the **MODE.WFM** file using the general purpose knob.
 - Push **ENTER** to select the file.
3. *Turn on the AWG2041 CH1 output:* Push the **CH1** button so that the LED above the CH1 output connector is on.
4. *Check triggered mode with manual triggering:* Push the AWG2041 **MANUAL TRIGGER** button and check that when the button is pushed, the oscilloscope displays a one-cycle sine wave.
5. *Check triggered mode with external triggering:*
 - a. *Enable function generator output:* Turn on the function generator output.
 - b. *Check triggering:* Check that for each trigger supplied by the function generator, the oscilloscope displays a one-cycle sine wave.
6. *End procedure:* Turn off the function generator output, and disconnect the function generator and oscilloscope.

Check Gated Mode

Electrical Characteristic Checked: Operating mode, Gated, on page B-3.

Equipment Required: Three 50 Ω coaxial cables, an adapter (BNC T male to 2 female), a function generator, and an oscilloscope.

Prerequisites: The AWG2041 meets the prerequisites listed on page E-7.

Procedure:

1. *Install test hookup and set test equipment controls:*
 - a. *Hook up the oscilloscope:* Connect the AWG2041 CH1 output connector through the coaxial cable to the CH1 vertical input connector on the oscilloscope. And attach the adapter (BNC T male to 2 female) to AWG2041 **TRIGGER INPUT** and connect through the coaxial cable to the CH2 vertical input connector on the oscilloscope.

- b. *Hook up the function generator:* Connect the adapter on **TRIGGER INPUT** through the coaxial cable to the function generator output connector (see Figure E-6).

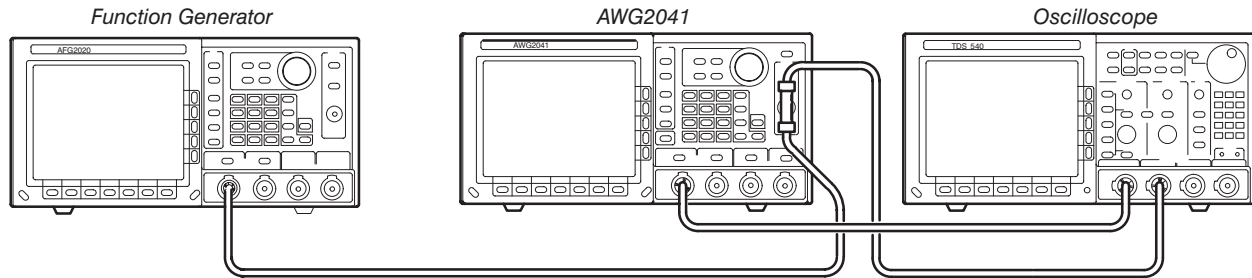

Figure E-6: Gated Mode Initial Test Hookup

- c. *Set oscilloscope controls:*

Vertical	CH1, CH2
CH1, CH2 coupling	DC
CH1 scale	0.5 V/div.
CH2 scale	2 V/div.
CH1 input impedance	50 Ω
CH2 input impedance	1 M Ω
Horizontal	
Sweep	1 μ s/div.
Trigger	
Source	CH1
Coupling	AC
Slope	Positive
Level	0 V
Mode	Auto

- d. *Set function generator (AFG2020) controls:*

Function	Square
Mode	Continuous
Parameter	
Frequency	1 Hz
Amplitude	2.0 V (4V into open circuit)
Offset	1.0 V (2V into open circuit)
Output	Off

2. *Set the AWG2041 controls and select the waveform file:*

- a. *Initialize AWG2041 controls:* Push **UTILITY**→**Misc**→**Config...**→**Reset to Factory**→**O.K.**

- b. *Modify the AWG2041 default settings:*
 - Push **MODE**→**Gated**→**Polarity** to highlight Positive.
- c. *Select the file:*
 - Push **SETUP**→**Waveform Sequence**.
 - Highlight the **MODE.WFM** file, using the general purpose knob.
 - Push **ENTER** to select the file.
3. *Turn on the AWG2041 CH1 output:* Push the **CH1** button so that the LED above the CH1 output connector is on.
4. *Check gated mode with manual trigger:* Push and hold the AWG2041 **MANUAL TRIGGER** button, and check that the oscilloscope continuously displays a sine wave while the **MANUAL TRIGGER** button is pushed.
5. *Check gated mode with gate signal:*
 - a. Change the oscilloscope horizontal sweep setting to 200 ms/div.
 - b. Set the oscilloscope trigger source to CH2.
 - c. *Apply gate signal:* Turn function generator output on.
 - d. *Check gated mode with positive gate signal:* Check that the oscilloscope displays a sine wave while the function generator gate signal amplitude is 1 V or greater (see Figure E-7). Gated level is set to 1 V.

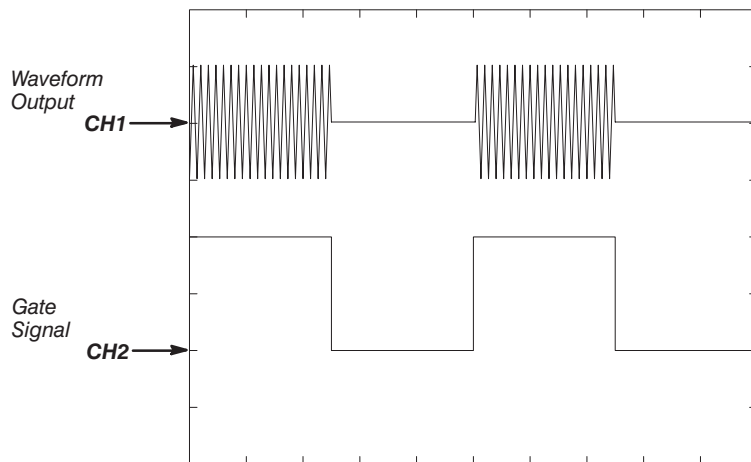

Figure E-7: Relationship between 1 Volt or Greater Gate Signal and Waveform Output Signal

- e. *Change the AWG2041 trigger polarity to negative:* Push **MODE**→**Polarity** to change the polarity to **Negative**.

- f. *Check gated mode with a negative gate signal:* Check that the oscilloscope displays a sine wave while the function generator gate signal amplitude is 1 V or less.
6. *End procedure:* Turn the function generator output off and disconnect the function generator and oscilloscope.

Check Burst Mode

Electrical Characteristic Checked: Operating mode, Burst, on page B-3.

Equipment Required: A 50 Ω coaxial cable and an oscilloscope.

Prerequisites: The AWG2041 meets the prerequisites listed on page E-7.

Procedure:

1. *Install test hookup and set test equipment controls:*
 - a. *Hook up the oscilloscope:* Connect the AWG2041 CH1 output connector through the coaxial cable to the CH1 vertical input connector on the oscilloscope (see Figure E-8).

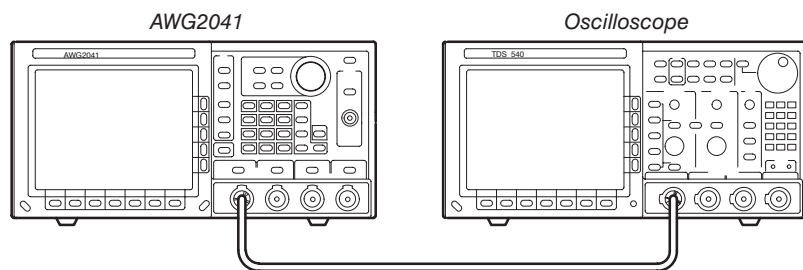

Figure E-8: Burst Mode Initial Test Hookup

- b. *Set oscilloscope controls:*

Vertical	CH1
CH1 coupling	DC
CH1 scale	0.5 V/div.
CH1 input impedance	50 Ω
Horizontal	
Sweep	500 ns/div.

Trigger	
Source	CH1
Coupling	AC
Slope	Positive
Level	0 V
Mode	Auto

2. *Set the AWG2041 controls and select the waveform file:*
 - a. *Initialize AWG2041 controls:* Push **UTILITY**→**Misc**→**Config...**→**Reset to Factory**→**O.K.**
 - b. *Change hardware sequencer mode to off:* Push **UTILITY**→**Misc**→**Config...**→**Change Sequencer Mode**→**O.K.**
The instrument initiates a reboot.
 - c. *Load the all files in the performance check/Adjustment disk:* See "Loading Files" on page E-10, load the all files into the instrument.
 - d. *Modify the AWG2041 default settings:*
 - Push **MODE**→**Burst**→**Burst Count** to highlight **Burst Count**.
 - Input the burst count of 60000 using the numeric key.
 - Push **ENTER** to enter the burst count.
 - e. *Select the file:*
 - Push **SETUP**→**Waveform Sequence**.
 - Highlight the **MODE.WFM** file, using the general purpose knob.
 - Push **ENTER** to select the file.
3. *Turn on the AWG2041 CH1 output:* Push the **CH1** button so that the LED above the CH1 output connector is on.
4. *Check Burst mode with manual trigger:* Push the AWG2041 **MANUAL TRIGGER** button, and check that the oscilloscope momentarily (about 60 ms) displays a sine wave after the **MANUAL TRIGGER** button is pushed.
5. *End procedure:* Disconnect the oscilloscope.

Check Waveform Advance Mode (Hardware Sequencer: On)

Electrical Characteristic Checked: Operating mode, Waveform Advance, on page B-3.

Equipment Required: A 50 Ω coaxial cable and an oscilloscope.

Prerequisites: The AWG2041 meets the prerequisites listed on page E-7.

Procedure:

1. *Install test hookup and set test equipment controls:*
 - a. *Hook up the oscilloscope:* Connect the AWG2041 CH1 output connector through the coaxial cable to the CH1 vertical input connector on the oscilloscope (see Figure E-9).

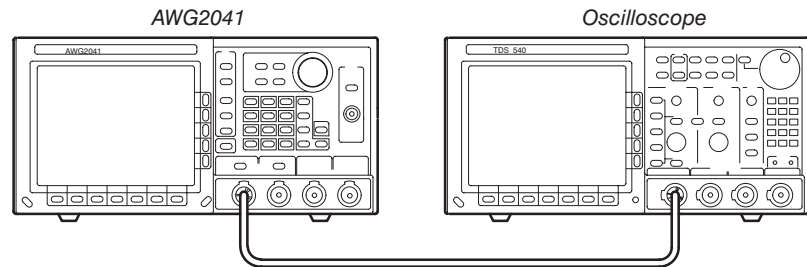

Figure E-9: Waveform Advance Mode Initial Test Hookup

- b. *Set oscilloscope controls:*

Vertical	CH1
CH1 coupling	DC
CH1 scale	0.2 V/div.
CH1 input impedance	50 Ω
Horizontal	
Sweep	200 μ s/div.
Trigger	
Source	CH1
Coupling	DC
Slope	Positive
Level	+100 mV
Mode	Normal

2. *Set the AWG2041 controls and select the waveform file:*
 - a. *Initialize AWG2041 controls:* Push **UTILITY**→**Misc**→**Config...**→**Reset to Factory**→**O.K.**
 - b. *Set AWG2041 controls:*
 - Push **MODE**→**Waveform Advance**→**Slope** to highlight Positive.
 - c. *Select waveform file:*
 - Push **SETUP**→**Waveform Sequence**.
 - Highlight the **MODE_ADV.SEQ** file using the general purpose knob.
 - Push **ENTER** to select the file.
3. *Turn on the AWG2041 CH1 output:* Push the **CH1** button so that the LED above the CH1 output connector is on.

4. *Check waveform advance mode with manual triggering:* Repeatedly push the AWG2041 **MANUAL TRIGGER** button, and check that the oscilloscope alternately displays two different frequency continuous sine waves at each manual trigger.
5. *End procedure:* Disconnect the oscilloscope.

Check Waveform Advance Mode (Hardware Sequencer: Off)

Electrical Characteristic Checked: Operating mode, Waveform Advance, on page B-3.

Equipment Required: A 50 Ω coaxial cable and an oscilloscope.

Prerequisites: The AWG2041 meets the prerequisites listed on page E-7.

Procedure:

1. *Install test hookup and set test equipment controls:*
 - a. *Hook up the oscilloscope:* Connect the AWG2041 CH1 output connector through the coaxial cable to the CH1 vertical input connector on the oscilloscope (see Figure E-10).

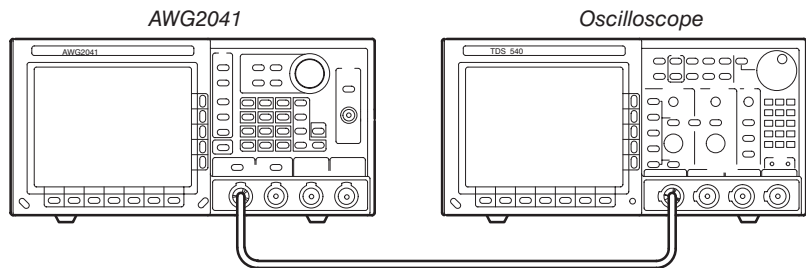

Figure E-10: Waveform Advance Mode Initial Test Hookup

- b. *Set oscilloscope controls:*

Vertical	CH1
CH1 coupling	DC
CH1 scale	0.2 V/div.
CH1 input impedance	50 Ω
Horizontal	
Sweep	200 μs/div.

Trigger	
Source	CH1
Coupling	DC
Slope	Positive
Level	+100 mV
Mode	Normal

2. *Set the AWG2041 controls and select the waveform file:*
 - a. *Initialize AWG2041 controls:* Push **UTILITY**→**Misc**→**Config...**→**Reset to Factory**→**O.K.**
 - b. *Change hardware sequencer mode to off:* Push **UTILITY**→**Misc**→**Config...**→**Change Sequencer Mode**→**O.K.**
The instrument initiates a reboot.
 - c. *Load the all files in the performance check/Adjustment disk:* See "Loading Files" on page E-10, load the all files into the instrument.
 - d. *Set AWG2041 controls:*
 - Push **MODE**→**Waveform Advance**.
 - e. *Select waveform file:*
 - Push **SETUP**→**Waveform Sequence**.
 - Highlight the **MODE_ADV.SEQ** file using the general purpose knob.
 - Push **ENTER** to select the file.
3. *Turn on the AWG2041 CH1 output:* Push the **CH1** button so that the LED above the CH1 output connector is on.
4. *Check waveform advance mode with manual triggering:* Repeatedly push the AWG2041 **MANUAL TRIGGER** button, and check that the oscilloscope alternately displays two different frequency sine waves at each manual trigger.
5. *End procedure:* Disconnect the oscilloscope.

Check Autostep Mode

Electrical Characteristic Checked: Operating mode, Autostep, on page B-3.

Equipment Required: Two 50 Ω coaxial cables (BNC connector), a 50 Ω coaxial cable (SMB-BNC connector), an adapter (BNC T male to 2 female), a function generator, and an oscilloscope.

Prerequisites: The AWG2041 meets the prerequisites listed on page E-7.

Procedure:

1. *Install test hookup and set test equipment controls:*

a. *Hook up the oscilloscope:*

- Connect the AWG2041 CH1 output through a BNC coaxial cable to the oscilloscope CH1 vertical input connector.

b. *Hook up the function generator:*

- Attach the adapter (BNC T male to 2 female) to the AWG2041 **TRIGGER INPUT** connector.
- Connect the function generator output through a BNC coaxial cable to the adapter on the AWG2041 **TRIGGER INPUT** connector.
- Connect the AWG2041 rear-panel **AUTO STEP IN** connector through a coaxial cable (SMB-BNC connector) to the adapter on the AWG2041 **TRIGGER INPUT** connector (see Figure E-11).

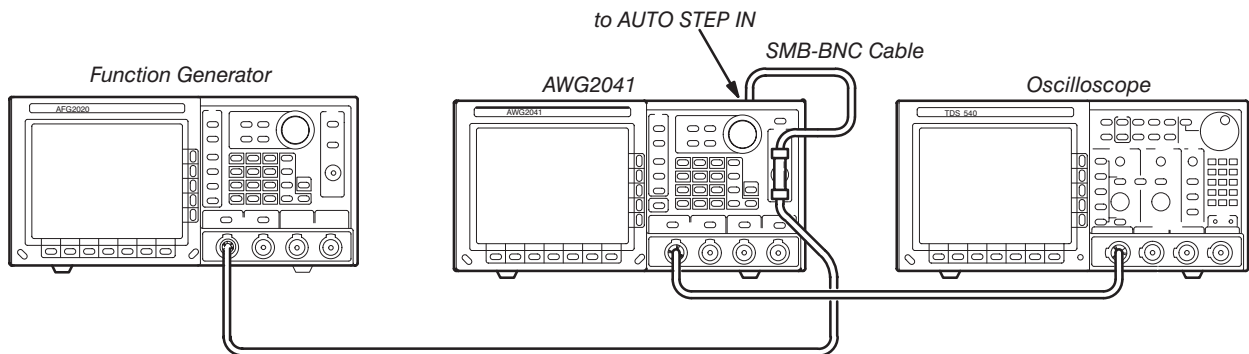

Figure E-11: Autostep Mode Initial Test Hookup

c. *Set the oscilloscope controls:*

Vertical	CH1
CH1 coupling	DC
CH1 scale	0.2 V/div.
CH1 input impedance	50 Ω
Horizontal	
Sweep	500 μs/div.
Trigger	
Source	CH1
Coupling	DC
Slope	Positive
Level	+100 mV
Mode	Normal

d. Set function generator (AFG2020) controls:

Function	Square
Mode	Continuous
Parameter	
Frequency	1 Hz
Amplitude	2.0 V (4V into open circuit)
Offset	1.0 V (2V into open circuit)
Output	Off

2. Set the AWG2041 controls and select the waveform file:

a. Initialize AWG2041 controls: Push **UTILITY**→**Misc**→**Config...**→**Reset to Factory**→**O.K.**

b. Modify AWG2041 default settings:

- Push **MODE**→**Autostep**→**Slope** to highlight Negative.
- Push **Config...** from the side menu to display its sub-menu.
- Push **Run** from the sub-menu to highlight the **Continuous**.
- Select **Select Autostep File** from the sub-menu to choose from the file list for CH1.
- Turn the general purpose knob to highlight the **MODE_AST.AST** file.
- Push **O.K.**

3. Turn on the AWG2041 CH1 output: Push the **CH1** button so that the LED above the CH1 output connector is on.

4. Check autostep mode with external triggering:

- Turn the function generator output on.
- Check that the oscilloscope alternately displays two different frequency waves with periods of 1 ms and 0.5 ms.

5. End procedure: Turn the function generator output off and disconnect the function generator and oscilloscope.

Check Slave Mode

This procedure checks AWG2041 operation of the slave mode.

NOTE. *This Slave Operation check has been factory verified. The check is performed only as necessary.*

Electrical Characteristic Checked: Operating mode, Slave, on page B-3.

Equipment Required: Three 50 Ω coaxial cables (BNC connector), two 50 Ω coaxial cables (SMB-SMB connector), an oscilloscope, a function generator, and an AWG2041(X) .

NOTE. *The (X) of AWG2041(X) means an additional AWG2041 Arbitrary Waveform Generator.*

Prerequisites: The AWG2041 meets the prerequisites listed on page E-7.

Procedure:

1. *Install test hookup and set test equipment controls:*
 - a. *Hook up the oscilloscope:*
 - Connect the AWG2041 CH1 output through a BNC coaxial cable to the oscilloscope CH1 vertical input connector.
 - Connect the AWG2041(X) CH1 output through a BNC coaxial cable to the oscilloscope CH2 vertical input connector.
 - b. *Hook up the function generator:*
 - Connect the function generator output through a BNC coaxial cable to the AWG2041(X) **TRIGGER INPUT** connector.
 - c. *Hook up the AWG2041(X) and AWG2041 :*
 - Connect the AWG2041 rear-panel **MASTER CLOCK OUT** connector through a coaxial cable (SMB-SMB connector) to the AWG2041(X) rear-panel **SLAVE CLOCK IN** connector.
 - Connect the AWG2041 rear-panel **SLAVE CLOCK IN** connector through a coaxial cable (SMB-SMB connector) to the AWG2041(X) rear-panel **MASTER CLOCK OUT** connector (see Figure E-12).

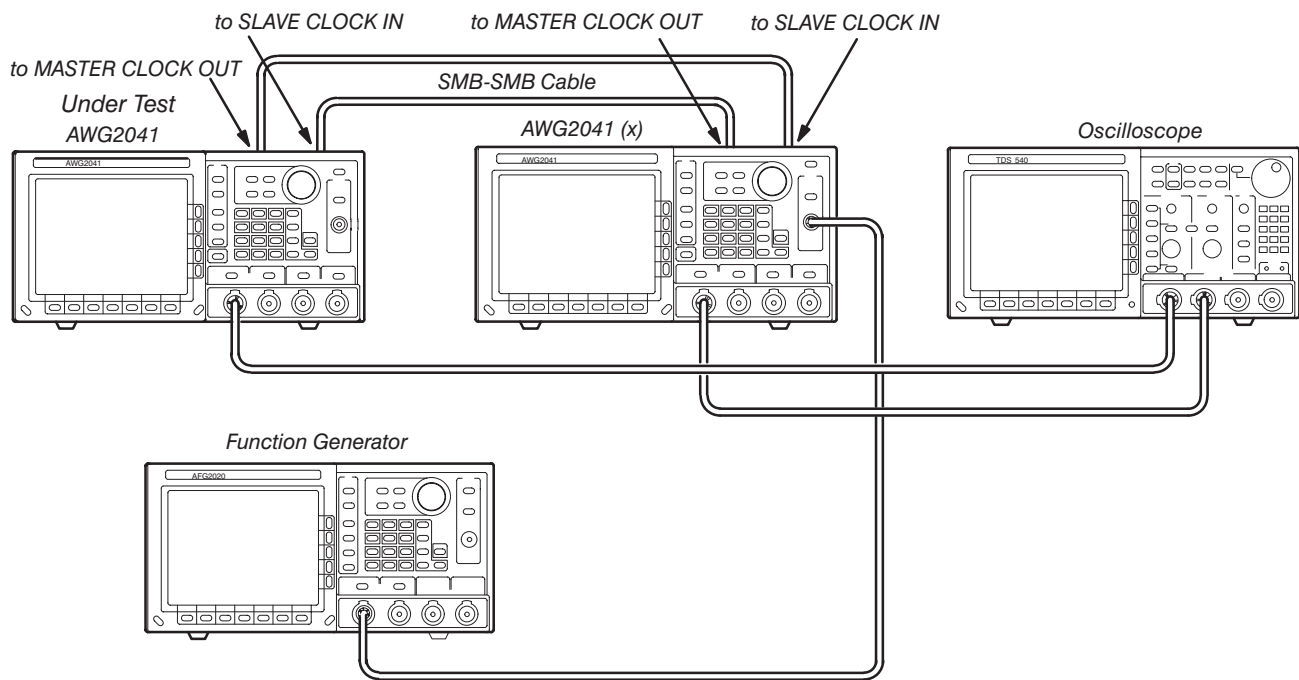

Figure E-12: Slave Mode Initial Test Hookup

d. *Set the oscilloscope controls:*

Vertical	CH1, CH2
CH1, CH2 coupling	DC
CH1, CH2 scale	0.2 V/div.
CH1, CH2 input impedance	50 Ω

Horizontal	
Sweep	500 ns/div.

Trigger	
Source	CH1
Coupling	DC
Slope	Positive
Level	+100 mV
Mode	Auto

e. *Set function generator (AFG2020) controls:*

Function	Square
Mode	Continuous
Parameter	
Frequency	100 kHz
Amplitude	2.0 V (4V into open circuit)
Offset	1.0 V (2V into open circuit)
Output	Off

2. *Set the AWG2041(X) controls and select the waveform file:*

- a. *Initialize AWG2041 controls:* Push **UTILITY**→**Misc**→**Config...**→**Reset to Factory**→**O.K.**
 - b. *Modify the AWG2041(X) default settings:*
 - Push **MODE**→**Triggered**.
 - c. *Select waveform file:*
 - Push **SETUP**→**Waveform Sequence**
 - Turn the general purpose knob to highlight the **MODE.WFM** file.
 - Push **ENTER** to select the file.
3. *Set the AWG2041 controls and select the waveform file:*
- a. *Initialize AWG2041 controls:* Push **UTILITY**→**Misc**→**Config...**→**Reset to Factory**→**O.K.**
 - b. *Modify the AWG2041 default settings:*
 - Push **MODE**→**Slave**.
 - c. *Select waveform file:*
 - Push **SETUP**→**Waveform Sequence**
 - Turn the general purpose knob to highlight the **MODE.WFM** file.
 - Push **ENTER** to select the file.
4. *Check slave mode operation:*
- *Turn on the AWG2041(X) and AWG2041 CH1 output:* Push the **CH1** button so that the LED above the CH1 output connector is on.
 - *Enable the function generator output:* Turn on the function generator output.
 - Check that the oscilloscope CH1 and CH2 displays same sine wave.
 - *Disable the function generator output:* Turn off the function generator output.
 - *Turn off the AWG2041(X) and AWG2041 CH1 output:* Push the **CH1** button so that the LED above the CH1 output connector is off.
5. *Change the test hookup of the function generator:*
- Disconnect the BNC coaxial cable from the AWG2041(X) **TRIGGER INPUT** connector. And connect it to the AWG2041 **TRIGGER INPUT** connector.
6. *Check master clock output:*
- *Modify the AWG2041(X) current setting:* Push **MODE**→**Slave**.
 - *Modify the AWG2041 current setting:* Push **MODE**→**TRIGGERED**.
 - *Turn on the AWG2041(X) and AWG2041 CH1 output:* Push the **CH1** button so that the LED above the CH1 output connector is on.

- *Enable the function generator output:* Turn on the function generator output.
 - Check that the oscilloscope CH1 and CH2 displays same sine wave.
7. *End procedure:* Turn off the function generator output and disconnect the function generator, oscilloscope, and AWG2041 (X).

Clock Frequency Check

These procedures check the accuracy of the AWG2041 clock frequency.

Check Clock Frequency Accuracy

Electrical Characteristic Checked: Clock Generator, Accuracy, on page B-7.

Equipment Required: A 50 Ω coaxial cable, a 50 Ω precision terminator and a frequency counter.

Prerequisites: The AWG2041 meets the prerequisites listed on page E-7.

Procedure:

1. *Install test hookup and set test equipment controls:*
 - a. *Hook up frequency counter:* Connect the AWG2041 CH1 output connector through a BNC coaxial cable and a 50 Ω precision terminator to the input connector on the frequency counter (see Figure E-13).

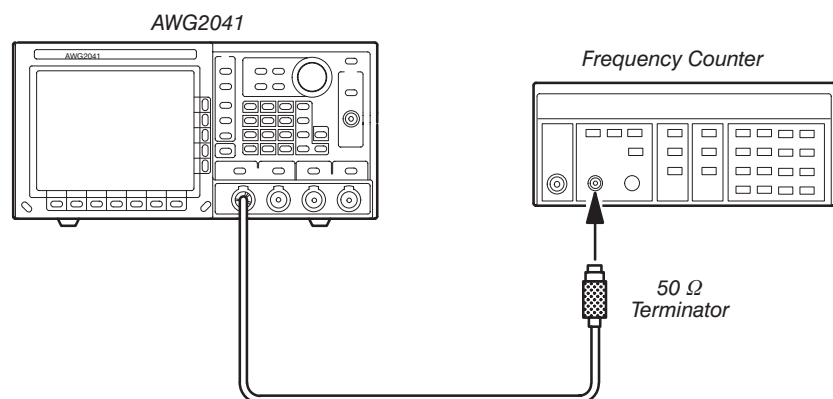

Figure E-13: Clock Frequency Accuracy Initial Test Hookup

- b. Set frequency counter controls:

INPUT A	
Slope	
Coupling	AC
FUNCTION	A FREQ

- 2. Set AWG2041 controls and select the waveform:
 - a. Initialize AWG2041 controls: Push **UTILITY**→**Misc**→**Config...**→**Reset to Factory**→**O.K.**
 - b. Select the waveform in the F.G. menu: Push **F.G.**, Sine wave is selected as default waveform.
 - c. Turn on the AWG2041 CH1 output: Push the **CH1** button so that the LED above the CH1 output connector is on.
- 3. Check clock frequency accuracy: Check that the frequency counter reading is in the range 10 MHz ±10 Hz.
- 4. End procedure: Disconnect the frequency counter.

Amplitude and Offset Accuracy Checks

These procedures check the accuracy of the AWG2041 waveform output; amplitude and offset.

NOTE. The amplitude and offset accuracy checks are structured as a continuous test. After Check Gain Accuracy, the next test uses the control settings from the last test and uses the next step in the sequence file.

Check Amplitude Accuracy

Electrical Characteristic Checked: Main Output, Amplitude, DC Accuracy, on page B-7.

Equipment Required: A 50 Ω coaxial cable, a 50 Ω precision terminator, a BNC (female)-to-dual banana adapter, and a digital multimeter (DMM).

Prerequisites: The AWG2041 meets the prerequisites listed on page E-7

Procedure:

1. *Install the test hookup and set test equipment controls:*
 - a. *Hook up DMM:* Connect the AWG2041 CH1 output through a 50 Ω coaxial cable, a 50 Ω precision terminator, and an adapter (BNC-to-dual banana) to the DMM INPUT connector (see Figure E-14).

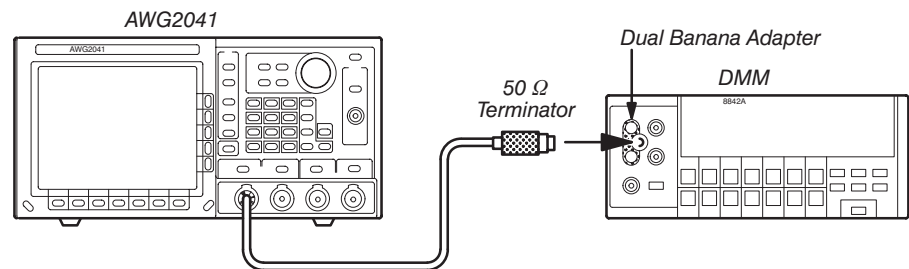
**Figure E-14: Amplitude Accuracy Initial Test Hookup**

- b. *Set DMM controls:*

Mode	VDC
Range	Auto
Input	Front
2. *Set the AWG2041 controls:*
 - a. *Initialize AWG2041 controls:* Push **UTILITY**→**Misc**→**Config...**→**Reset to Factory**→**O.K.**
 - b. *Set the AWG2041 controls:*
 - Push **F.G.**→**Pulse**→**Duty**.
 - Turn the general purpose knob to set the value for 100.
 - Push **ENTER**.
 - c. *Turn on the AWG2041 CH1 output:* Push the **CH1** button so that the LED above the CH1 output connector is on.
3. *Check amplitude accuracy:*
 - a. *Set the AWG2041 amplitude:*
 - Push **Amplitude**.
 - *Enter numeric value of 20:* Push 2 and 0 key in this order.
 - Push **kHz/ms/mV** key.
 - b. *Operate the AWG2041 control and note the reading on DMM :*
 - Set the Polarity to Normal on the AWG2041 side menu and note the value displayed on the DMM.

- Set the Polarity to Invert on the AWG2041 side menu and note the value displayed on the DMM.
 - c. *Check the difference of the two values:*
 - Check that the difference of the two values is in the range of $20\text{ mV} \pm 2.2\text{ mV}$.
 - d. *Set the AWG2041 amplitude:*
 - Enter numeric value of 200: Push 2, 0, and 0 key in this order.
 - Push **kHz/ms/mV** key.
 - e. *Operate the AWG2041 control and note the reading on DMM :*
 - Set the Polarity to Normal on the AWG2041 side menu and note the value displayed on the DMM.
 - Set the Polarity to Invert on the AWG2041 side menu and note the value displayed on the DMM.
 - f. *Check the difference of the two values:*
 - Check that the difference of the two values is in the range of $200\text{ mV} \pm 4\text{ mV}$.
 - g. *Set the AWG2041 amplitude:*
 - Enter numeric value of 2: Push 2 key.
 - Push **Hz/s/V** key.
 - h. *Operate the AWG2041 control and note the reading on DMM :*
 - Set the Polarity to Normal on the AWG2041 side menu and note the value displayed on the DMM.
 - Set the Polarity to Invert on the AWG2041 side menu and note the value displayed on the DMM.
 - i. *Check the difference of the two values:*
 - Check that the difference of the two values is in the range of $2\text{ V} \pm 0.022\text{ V}$.
4. *Check $\overline{\text{CH1}}$:* Repeat the *Amplitude Accuracy Checks* for the AWG2041 CH1.
5. *End procedure:* Retain the test hookup and control settings.

Check Offset Accuracy

Electrical Characteristic Checked: Main Output, Offset, Accuracy, on page B-7.

Equipment Required: A $50\ \Omega$ coaxial cable, a $50\ \Omega$ precision terminator, a BNC (female)-to-dual banana adapter, and a digital multimeter (DMM).

Prerequisites: The AWG2041 meets the prerequisites listed on page E-7

Procedure:

1. Use the test hookup from previous check.
2. Set the AWG2041 controls:
 - a. Initialize AWG2041 controls: Push **UTILITY**→**Misc**→**Config...**→**Reset to Factory**→**O.K.**
 - b. Set the AWG2041 controls:
 - Push **F.G.**→**Sine**→**Amplitude**.
 - Turn the general purpose knob to set the amplitude for 0.020 V.
 - c. Turn on the AWG2041 CH1 output: Push the **CH1** button so that the LED above the CH1 output connector is on.
3. Check offset accuracy:
 - a. Set the AWG2041 offset:
 - Push **Offset**.
 - Enter numeric value of 0: Push 0 key.
 - Push **Enter** key.
 - b. Check the reading on DMM: Check that the value is in the range of $0\text{ V} \pm 5\text{ mV}$.
 - c. Set the AWG2041 offset:
 - Enter numeric value of 1: Push 1 key.
 - Push **Hz/s/V** key.
 - d. Check the reading on DMM: Check that the value is in the range of $1\text{ V} \pm 0.015\text{ V}$.
 - e. Set the AWG2041 offset:
 - Enter numeric value of -1: Push -1 key.
 - Push **Hz/s/V** key.
 - f. Check the reading on DMM: Check that the value is in the range of $-1\text{ V} \pm 0.015\text{ V}$.
4. Check $\overline{CH1}$: Repeat the *Offset Accuracy Checks* for the AWG2041 $\overline{CH1}$.
5. End procedure: Disconnect the DMM and 50 Ω terminator.

Pulse Response Checks

This procedure checks the pulse response characteristics of the AWG2041 output waveforms at amplitudes of 0.5 and 1 V.

Electrical Characteristic Checked: Main Output, Pulse Response, on page B-8.

Equipment Required: A 50 Ω coaxial cable and an oscilloscope.

Prerequisites: The AWG2041 meets the prerequisites listed on page E-7.

Procedure:

1. *Install test hookup and set test equipment controls:*

- a. *Hook up the oscilloscope:* Connect the AWG2041 CH1 output connector through the coaxial cable to the CH1 vertical input connector on the oscilloscope (see Figure E-15).

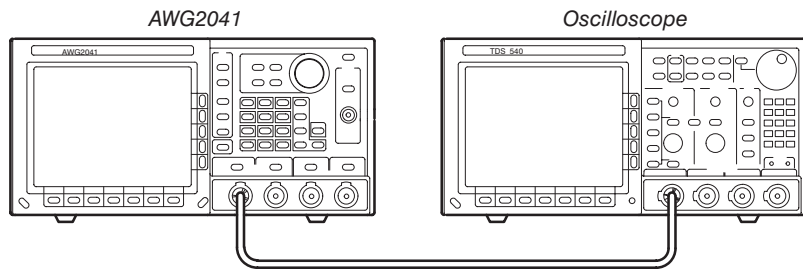

Figure E-15: Pulse Response Initial Test Hookup

b. *Set oscilloscope controls:*

Vertical	CH1
Coupling	DC
Scale	0.2 V/div.
Input impedance	50 Ω
Horizontal	
Sweep	1 ns/div.
Trigger	
Source	CH1
Coupling	AC
Slope	Positive
Level	0 V
Mode	Auto

2. *Set the AWG2041 controls and select the waveform file:*

- a. *Initialize AWG2041 controls:* Push **UTILITY**→**Misc**→**Config...**→**Reset to Factory**→**O.K.**
- b. *Select waveform file:*
 - Push **SETUP**→**Waveform Sequence**.
 - Turn the general purpose knob to select the **PULSE.WFM** file.
 - Push **ENTER**.
3. *Turn on the AWG2041 CH1 output:* Push the **CH1** button so that the LED above the CH1 output connector is on.
4. *Check pulse response at 1 V amplitude:*
 - a. *Check rise time:* Check that the rise time of the waveform displayed on the oscilloscope from the 10% point to the 90% point is 1.5 ns or less.
 - b. *Check aberration:*
 - Set oscilloscope sweep to 20 ns/div.
 - Check that the aberration of the displayed waveform are within $\pm 7\%$.
 - c. *Check flatness:*
 - Set oscilloscope sweep to 200 ns/div.
 - Check that the flatness of the displayed waveform is within $\pm 3\%$ after 50 ns from the rising edge.
5. *Check pulse response at 2 V amplitude:*
 - a. *Change the oscilloscope controls:*

Vertical	CH1
CH1 scale	0.5 V/div.
Horizontal	
Sweep	1 ns/div.
 - b. *Change the AWG2041 controls:*
 - Push **SETUP**→**Ampl** to change the amplitude for CH1.
 - Press the numeric key **2** and press the units key **V** to select an amplitude of 2 V.
 - c. *Repeat substeps 4a through c, checking to the follow limits:*

Rise time	2.5 ns, maximum
Aberration	$\pm 10\%$, maximum
Flatness	$\pm 3\%$, maximum
6. *Check pulse response for $\overline{CH1}$:* Repeat this Pulse Response Check procedure using the AWG2041 $\overline{CH1}$ output and selecting the waveform and setting controls for $\overline{CH1}$.

7. *End procedure:* Disconnect the oscilloscope.

Sine Wave Checks

This procedure checks the sine wave characteristics of the AWG2041 output waveforms.

Electrical Characteristic Checked: Main Output, Sine Wave Characteristics, on page B-8.

Equipment Required: A 50 Ω coaxial cable, a DC block, an adapter (N male to BNC female), and a spectrum analyzer.

Prerequisites: The AWG2041 meets the prerequisites listed on page E-7.

Procedure:

1. *Install test hookup and set test equipment controls:*
 - a. *Hook up the spectrum analyzer:* Connect the AWG2041 CH1 output connector through the coaxial cable, adapter, and DC Block to the input connector on the spectrum analyzer (see Figure E-16).

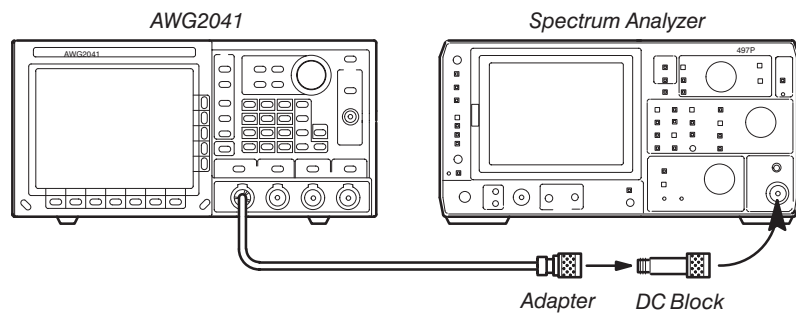

Figure E-16: Sine Wave Initial Test Hookup

- b. *Set spectrum analyzer controls:*

Center frequency	200 MHz
Span	50 MHz/div
Vertical	10 dB/div
Reference level	0 dBm
RF attenuation	20 dB
Video filter	3 kHz
Resolution BW	1 MHz
Storage mode	Peak

2. *Set the AWG2041 controls and select the waveform file:*
 - a. *Initialize AWG2041 controls:* Push **UTILITY**→**Misc**→**Config...**→**Reset to Factory**→**O.K.**
 - b. *Select waveform file:*
 - Push **SETUP**→**Waveform Sequence**.
 - Turn the general purpose knob to highlight the **SINE.WFM** file.
 - Push **ENTER**.
3. *Turn on the AWG2041 CH1 output:* Push the **CH1** button so that the LED above the CH1 output connector is on.
4. *Check harmonics and noise level:*
 - a. *Check harmonics level:*
 - Check that the harmonics level of the spectrum displayed on the spectrum analyzer from 0 Hz to 400 MHz is –45 dBc or less.
 - b. *Check noise Level:*
 - Check that the noise level of the spectrum displayed on the spectrum analyzer from 0 Hz to 400 MHz is –50 dBc or less.
5. *End procedure:* Disconnect the spectrum analyzer.

AUX Output Checks

This procedure checks the level and waveform of the MARKER Out signal, the delay time from trigger signal to SYNC output, and the delay time from trigger signal to BUSY output.

Electrical Characteristic Checked: Auxiliary Output, Marker Level, SYNC Delay, BUSY Delay on page B-8.

Equipment Required: Three 50 Ω coaxial cable (BNC connector), a 50 Ω coaxial cable (SMB-BNC connector), an adapter (BNC T male to 2 female), an adapter (BNC female to dual banana), a 50 Ω precision terminator, an oscilloscope, a digital multimeter (DMM), and a function generator.

Prerequisites: The AWG2041 meets the prerequisites listed on page E-7.

Procedure:

1. *Install test hookup and set test equipment controls:*
 - a. *Hook up the DMM:* Connect the AWG2041 **MARKER1** output through a 50 Ω coaxial cable, a 50 Ω precision terminator, and an adapter (BNC-to-dual banana) to the DMM input connector (see Figure E-17).

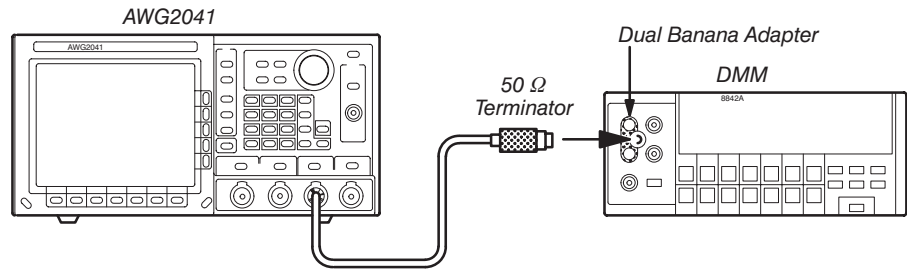

Figure E-17: Marker Level Initial Test Hookup

- b. *Set DMM controls:*

Mode	VDC
Range	Auto
Input	Front
Output	Off
2. *Set the AWG2041 controls and select the waveform file:*
 - a. *Initialize AWG2041 controls:* Push **UTILITY**→**Misc**→**Config...**→**Reset to Factory**→**O.K.**
 - b. *Select waveform file:*
 - Push **SETUP**→**Waveform Sequence**.
 - Turn the general purpose knob to highlight the **MARKER-L.WFM** file.
 - Push **ENTER**.
3. *Turn on the AWG2041 CH1 output:* Push the **CH1** button so that the LED above the CH1 output connector is on.
4. *Check MARKER1 output low level:*
 - a. *Set MARKER1 level to -2 V:*
 - Push **SETUP**→**Marker Level**→**Marker 1 Low**.
 - *Enter numeric value of -2:* Push **-** and **2** key in this order.
 - Push **Hz/s/V** key.
 - b. *Check MARKER1 low level:*
 - Check that the value displayed on the DMM is in the range of $-2.0\text{ V} \pm 0.2\text{ V}$.
 - c. *Set MARKER1 level to 1.9 V:*
 - *Enter numeric value of 1.9:* Push **1**, **.**, and **9** key in this order.
 - Push **Hz/s/V** key.
 - d. *Check MARKER1 low level:*
 - Check that the value displayed on the DMM is in the range of $1.9\text{ V} \pm 0.2\text{ V}$.

5. *Change hookup: Disconnect the BNC coaxial cable from the MARKER1 output connector and connect the cable to the MARKER2 output connector.*
6. *Check MARKER2 output low level:*
 - a. *Set MARKER2 level to -2 V:*
 - Push **SETUP**→**Marker Level**→**Marker 2 Low**.
 - Enter numeric value of -2 : Push **-** and **2** key in this order.
 - Push **Hz/s/V** key.
 - b. *Check MARKER2 low level:*
 - Check that the value displayed on the DMM is in the range of $-2.0\text{ V} \pm 0.2\text{ V}$.
 - c. *Set MARKER2 level to 1.9 V:*
 - Enter numeric value of 1.9 : Push **1**, **.**, and **9** key in this order.
 - Push **Hz/s/V** key.
 - d. *Check MARKER2 low level:*
 - Check that the value displayed on the DMM is in the range of $1.9\text{ V} \pm 0.2\text{ V}$.
7. *Check MARKER2 output High level:*
 - a. *Select waveform file:*
 - Push **SETUP**→**Waveform Sequence**.
 - Turn the general purpose knob to highlight the **MARKER-H.WFM** file.
 - Push **ENTER**.
 - b. *Set MARKER2 level to -1.9 V:*
 - Push **SETUP**→**Marker Level**→**Marker 2 High**.
 - Enter numeric value of -1.9 : Push **-**, **1**, **.**, and **9** key in this order.
 - Push **Hz/s/V** key.
 - c. *Check MARKER2 High level:*
 - Check that the value displayed on the DMM is in the range of $-1.9\text{ V} \pm 0.2\text{ V}$.
 - d. *Set MARKER2 level to 2 V:*
 - Enter numeric value of 2 : Push **2** key.
 - Push **Hz/s/V** key.
 - e. *Check MARKER2 High level:*
 - Check that the value displayed on the DMM is in the range of $2.0\text{ V} \pm 0.2\text{ V}$.

8. *Change hookup:* Disconnect the BNC coaxial cable from the **MARKER2** output connector and connect the cable to the **MARKER1** output connector.
9. *Check MARKER1 output High level:*
 - a. *Set MARKER1 level to -1.9 V:*
 - Push **SETUP**→**Marker Level**→**Marker 1 High**.
 - *Enter numeric value of -1.9 :* Push **-**, **1**, **.**, and **9** key in this order.
 - Push **Hz/s/V** key.
 - b. *Check MARKER1 High level:*
 - Check that the value displayed on the DMM is in the range of $-1.9\text{ V} \pm 0.2\text{ V}$.
 - c. *Set MARKER1 level to 2 V:*
 - *Enter numeric value of 2 :* Push **2** key.
 - Push **Hz/s/V** key.
 - d. *Check MARKER1 High level:*
 - Check that the value displayed on the DMM is in the range of $2.0\text{ V} \pm 0.2\text{ V}$.
10. *Change the hookup:*
 - a. *Disconnect the BNC coaxial cable, terminator, and adapter (BNC-to-dual banana) from the DMM input connector.*
 - b. *Hook up the oscilloscope:* Connect the AWG2041 **MARKER1** output connector through the coaxial cable to the CH1 vertical input connector on the oscilloscope (see Figure E-18).

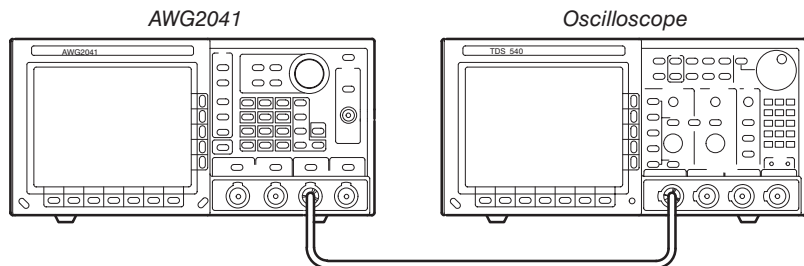

Figure E-18: Marker Waveform Initial Test Hookup

c. *Set oscilloscope controls:*

Vertical	CH1
CH1 Coupling	DC
CH1 Scale	1 V/div.
CH1 Input Impedance	50 Ω
CH2 Scale	2 V/div.
CH2 Input Impedance	1 M Ω
Horizontal	
Sweep	200 ns/div.
Trigger	
Source	CH1
Coupling	AC
Slope	Positive
Level	0 V
Mode	Auto

11. *Set the AWG2041 controls and select the waveform file:*

a. *Initialize AWG2041 controls:* Push **UTILITY**→**Misc**→**Config...**→**Reset to Factory**→**O.K.**

b. *Select waveform file:*

- Push **SETUP**→**Waveform Sequence**.
- Turn the general purpose knob to highlight the **MARKER.WFM** file.
- Push **ENTER**.

12. *Turn on the AWG2041 CH1 output:* Push the **CH1** button so that the LED above the CH1 output connector is on.

13. *Check MARKER1 output waveform:*

a. Check the oscilloscope display for a 1 μ s, 2 V_{p-p} square wave.

14. *Change hookup:* Disconnect the BNC coaxial cable to the **MARKER1** output connector and connect the cable to the **MARKER2 output connector**.

15. *Check MARKER2 output waveform:*

a. Check the oscilloscope display for a 1 μ s, 2 V_{p-p} square wave.

16. *Change the hookup and set test equipment controls:*

a. *Hook up the oscilloscope:*

- Attach the adapter (BNC T male to 2 female) to the AWG2041 **TRIGGER INPUT** connector.
- Disconnect the BNC coaxial cable on the AWG2041 **MARKER2** output connector and connect it to the adapter (BNC T male to 2 female) on the AWG2041 **TRIGGER INPUT** connector.

- Connect the **SYNC OUT** connector on the rear panel of AWG2041 through the coaxial cable (BNC-SMB) to the CH2 vertical input connector on the oscilloscope.
- b. *Hook up the function generator:*
- Connect the function generator output through a BNC coaxial cable to the adapter on the AWG2041 **TRIGGER INPUT** connector (see Figure E-19).

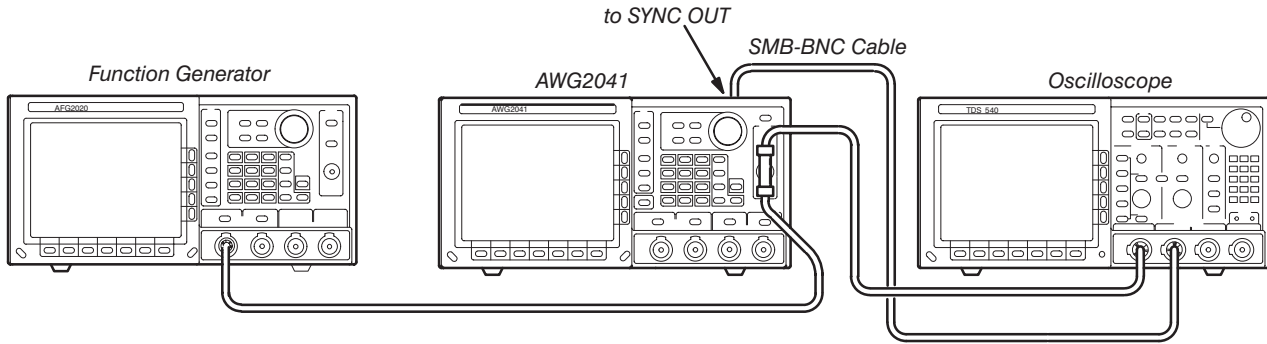

Figure E-19: SYNC Delay Initial Test Hookup

- c. *Set oscilloscope controls:*

Vertical	CH1
CH1 Coupling	DC
CH1 Scale	2 V/div.
CH1 Input Impedance	1 M Ω
CH2 Coupling	DC
CH2 Scale	2 V/div.
CH2 Input Impedance	1 M Ω
Horizontal	
Sweep	20 ns/div.

- d. *Set function generator (AFG2020) controls:*

Function	Square
Mode	Continuous
Parameter	
Frequency	100 kHz
Amplitude	2.0 V (4V into open circuit)
Offset	1.0 V (2V into open circuit)

17. *Set the AWG2041 controls: Push **MODE**→**Triggered**.*

18. *Check SYNC delay:* Check that the SYNC rising edge (Channel 2) is delayed by 60 ns or less to the trigger rising edge (Channel 1).
19. *Change hookup:* Disconnect the coaxial cable to the SYNC OUT connector and connect the cable to the BUSY OUT connector on the rear panel of AWG2041 .
20. *Check BUSY delay:* Check that the BUSY rising edge (Channel 2) is delayed by 60 ns or less to the trigger rising edge (Channel 1).
21. *End procedure:* Turn the function generator output off and disconnect the function generator and oscilloscope.

External Trigger Input Checks

This procedure checks the external trigger level accuracy, delay time trigger to marker, and trigger holdoff of the AWG2041 .

Electrical Characteristic Checked: Auxiliary Input, TRIGGER, Accuracy, Delay, Trigger Hold Off, on page B-9.

Equipment Required: Three 50 Ω coaxial cable (BNC connector), an adapter (BNC T male to 2 female), an adapter (BNC female to dual banana), an oscilloscope, a digital multimeter (DMM), and a function generator.

Prerequisites: The AWG2041 meets the prerequisites listed on page E-7.

Procedure:

1. *Install test hookup and set test equipment controls:*
 - a. *Hook up oscilloscope:* Connect the AWG2041 CH1 output connector through a BNC coaxial cable to the CH1 vertical input connector on the oscilloscope .
 - b. *Hook up DMM:*
 - Attach the adapter (BNC T male to 2 female) to AWG2041 **TRIGGER INPUT**
 - Connect the adapter (BNC T male to 2 female) through a coaxial cable and adapter (BNC-to-dual banana) to the DMM input connector.
 - c. *Hook up function generator:* Connect the adapter (BNC T male to 2 female) on **TRIGGER INPUT** through a coaxial cable to the function generator output (see Figure E-20).

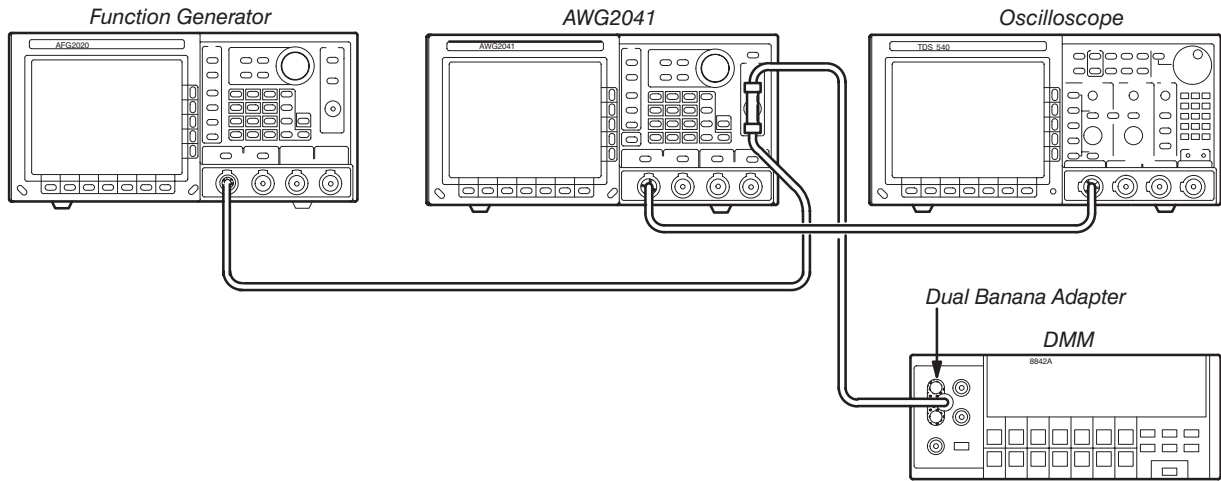

Figure E-20: Trigger Input Initial Test Hookup

d. Set oscilloscope controls:

Vertical	CH1 CH2
CH1 Coupling	DC
CH1 Scale	1 V/div.
CH1 Input Impedance	50 Ω
Horizontal	
Sweep	20 ns/div.
Trigger	
Source	CH1
Coupling	AC
Slope	Positive
Level	0 V
Mode	Auto

e. Set DMM controls:

Mode	VDC
Range	Auto
Input	Front

f. Set function generator (AFG2020) controls:

Function	Square
Mode	Continuous
Parameter	
Frequency	100 kHz
Amplitude	0.0 V
Offset	-0.5 V (-1V into open circuit)
Output	On

2. *Set AWG2041 controls and select the AWG2041 waveform file:*
 - a. *Initialize AWG2041 controls:* Push **UTILITY**→**Misc**→**Config...**→**Reset to Factory**→**O.K.**
 - b. *Modify AWG2041 default settings:*
 - Push **MODE**→**Gated**→**Polarity** to highlight Positive.
 - Select **Level** from the side menu, and turn the general purpose knob to select 0 V. (You can also use the numeric and units keys to select 0 V; then push **ENTER**.)
 - c. *Select waveform file:*
 - Push **SETUP**→**Waveform Sequence**.
 - Turn the general purpose knob to highlight the **TRIGGER.WFM** file.
 - Push **ENTER**.
3. *Turn on the AWG2041 CH1 output:* Push the **CH1** button so that the LED above the CH1 output connector is on.
4. *Check external trigger level accuracy:*
 - a. *Adjust oscilloscope controls:* Press and hold the AWG2041 **MANUAL TRIGGER** button and adjust the oscilloscope vertical and horizontal position to display the waveform from the AWG2041. Release the **MANUAL TRIGGER** button.
 - b. *Check external trigger level accuracy:*
 - Gradually increment the function generator offset level until a waveform is displayed on the oscilloscope.
 - Check that the value displayed on the DMM is within $0\text{ V} \pm 0.1\text{ V}$ when the waveform is first displayed.
 - c. *Modify AWG2041 settings:*
 - Select **Level** from the side menu, and turn the general purpose knob to select 5 V. (You can also use the numeric and units keys to select 5 V; then push **ENTER**.)
 - d. *Check external trigger level accuracy:*
 - Gradually increment the function generator offset level until a waveform is displayed on the oscilloscope.
 - Check that the value displayed on the DMM is within $5\text{ V} \pm 0.1\text{ V}$ when the waveform is first displayed.
 - e. *Modify AWG2041 settings:*
 - Select **Level** from the side menu, and turn the general purpose knob to select -5 V. (You can also use the numeric and units keys to select -5 V; then push **ENTER**.)

- f. *Check external trigger level accuracy:*
 - Decrement the function generator offset level under $-3V$ ($-6V$ into open circuit).
 - Gradually increment the function generator offset level until a waveform is displayed on the oscilloscope.
 - Check that the value displayed on the DMM is within $-5 V \pm 0.1 V$ when the waveform is first displayed.

5. *Change the hookup and set test equipment controls:*

- a. *Hook up the oscilloscope:*
 - Disconnect the BNC coaxial cable from the adapter (BNC female to dual banana) on the DMM output connector and connect it to the CH1 vertical input connector on the oscilloscope.
 - Connect the AWG2041 **MARKER1** output connector through the BNC coaxial cable to the CH2 vertical input connector on the oscilloscope (see Figure E-21).

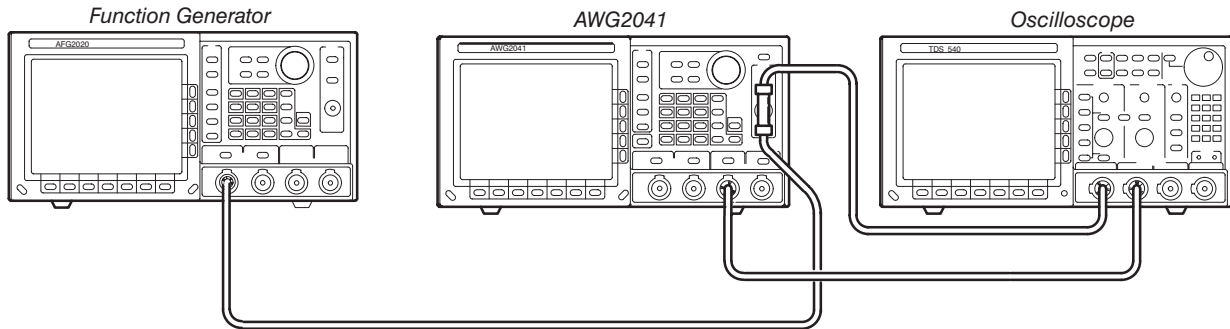

Figure E-21: Trigger to Marker Delay Initial Test Hookup

- b. *Set oscilloscope controls:*

Vertical	CH1	CH2
CH1 Scale	2 V/div.	
CH1 Input Impedance	1 M Ω	
CH2 Scale	1 V/div.	
CH2 Input Impedance	50 Ω	
Horizontal		
Sweep	20 ns/div.	

6. *Set AWG2041 controls and select the AWG2041 waveform file:*

- a. *Modify AWG2041 settings:*
 - Push **MODE** \rightarrow **Triggered**.
- b. *Select waveform file:*
 - Push **SETUP** \rightarrow **Waveform Sequence**.

- Turn the general purpose knob to highlight the **TRIGGER.WFM** file.
 - Push **ENTER**.
7. *Change the function generator (AFG2020) controls:*
 - a. Change the amplitude to 0.5 V (1 V into open circuit).
 8. *Check Trigger to Marker delay:*
 - a. Check that the time TRIGGER rising edge to the **MARKER1** rising edge is 48 ns or less.
 9. *Change the oscilloscope controls:*
 - a. Change the oscilloscope sweep to 500 ns/div.
 - b. Change the function generator to 800 kHz.
 10. *Check trigger holdoff:*
 - a. Gradually increment the function generator frequency from 800 kHz until the **MARKER1** one period waveform during the TRIGGER two period waveform are displayed on the oscilloscope.
 - b. Check that the time **MARKER1** falling edge to rising edge is 500 ns or less.
 11. *End procedure:* Turn off the function generator output and disconnect the function generator and oscilloscope.

External CLOCK IN Check

This procedure checks the AWG2041 response to an external CLOCK IN signal.

Electrical Characteristic Checked: Auxiliary Input, EXTERNAL CLOCK, Sensitivity, on page B-10.

Equipment Required: A 50 Ω coaxial cable (BNC connector), a 50 Ω coaxial cable (SMB-BNC connector), an adapter (N male to BNC female), an oscilloscope, a RF signal generator.

Prerequisites: The AWG2041 meets the prerequisites listed on page E-7.

Procedure:

1. *Install test hookup and set test equipment controls:*
 - a. *Hook up oscilloscope:* Connect the AWG2041 CH1 output connector through a BNC coaxial cable to the CH1 vertical input connector on the oscilloscope.

- b. *Hook up RF signal generator:* Connect the AWG2041 rear-panel **EXT CLOCK IN** connector through an adapter (N male to BNC female) and a coaxial cable (SMB-BNC) to the output head of the RF signal generator (see Figure E-22).

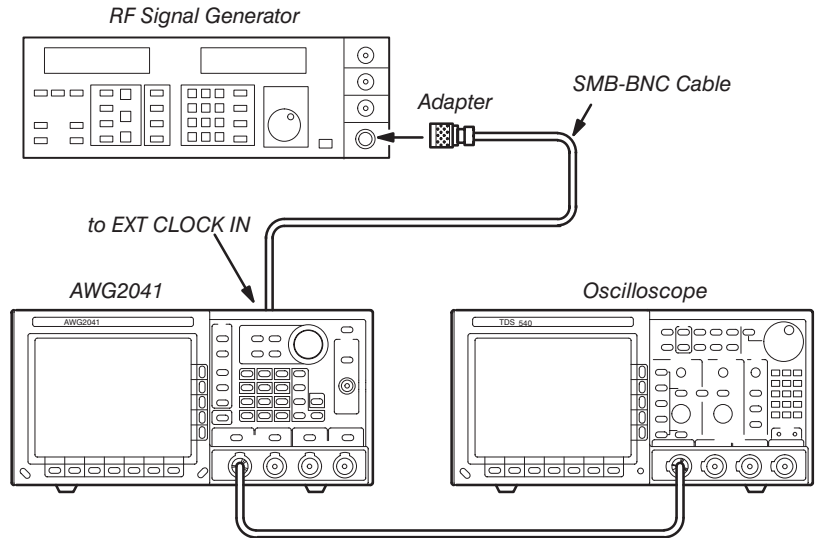

Figure E-22: External CLOCK IN Initial Test Hookup

- c. *Set oscilloscope controls:*

Vertical	CH1
Coupling	DC
Scale	0.2 V/div.
Input Impedance	50 Ω
Horizontal	
Sweep	500 ns/div.
Trigger	
Source	CH1
Coupling	DC
Slope	Positive
Level	+100 mV
Mode	Auto

- d. *Set RF signal generator controls:*

Frequency	1.024 GHz
Amplitude	-4.0 dBm (400mV _{p-p})

2. Set AWG2041 controls and select the AWG2041 waveform file:
 - a. Initialize AWG2041 controls: Push **UTILITY**→**Misc**→**Config...**→**Reset to Factory**→**O.K.**
 - b. Select waveform file:
 - Push **SETUP**→**Waveform Sequence**.
 - Turn the general purpose knob to highlight the **MODE.WFM** file.
 - Push **ENTER**.
 - c. Modify AWG2041 controls: Push **SETUP**→**Clock**→**Source**→**External**
3. Turn on the AWG2041 CH1 output: Push the **CH1** button so that the LED above the CH1 output connector is on.
4. Check external clock operation:
 - a. Check the output: Check that the oscilloscope displays a sine wave with vertical 5 divisions and horizontal 2 divisions.
5. End procedure: Turn off the RF signal generator output and disconnect the RF signal generator and oscilloscope.

Digital Data Out Checks (Option 03)

This procedure checks the AWG2041 Digital Data Out at the rear panel. This check requires that the AWG2041 has Option 03 installed.

Electrical Characteristic Checked: Digital Data Out, on page B-4.

Equipment Required: Two 50 Ω coaxial cable (SMB-BNC connector), an adapter (BNC male to SMA female), an adapter (SMA male to SMA male), an adapter (SMA female to SMA female), an adapter (BNC female to SMA male), an adapter (BNC female to dual banana), an ECL terminator, a DC power supply, an oscilloscope.

Prerequisites: The AWG2041 meets the prerequisites listed on page E-7.

Procedure:

1. Install test hookup and set test equipment controls:
 - a. Hook up oscilloscope: Connect the CLOCK output connector of AWG2041 DIGITAL OUT through the BNC-SMA coaxial cable, adapter (BNC female to SMA male), adapter (SMA female to SMA female), ECL terminator, adapter (SMA male to SMA male), adapter (BNC male to SMA female) to the CH1 vertical input connector on the oscilloscope.
 - b. Hook up DC power supply: Connect the ECL terminator BIAS IN through the BNC-SMB coaxial cable and adapter (BNC female to dual banana) to DC power supply (see Figure E-23).

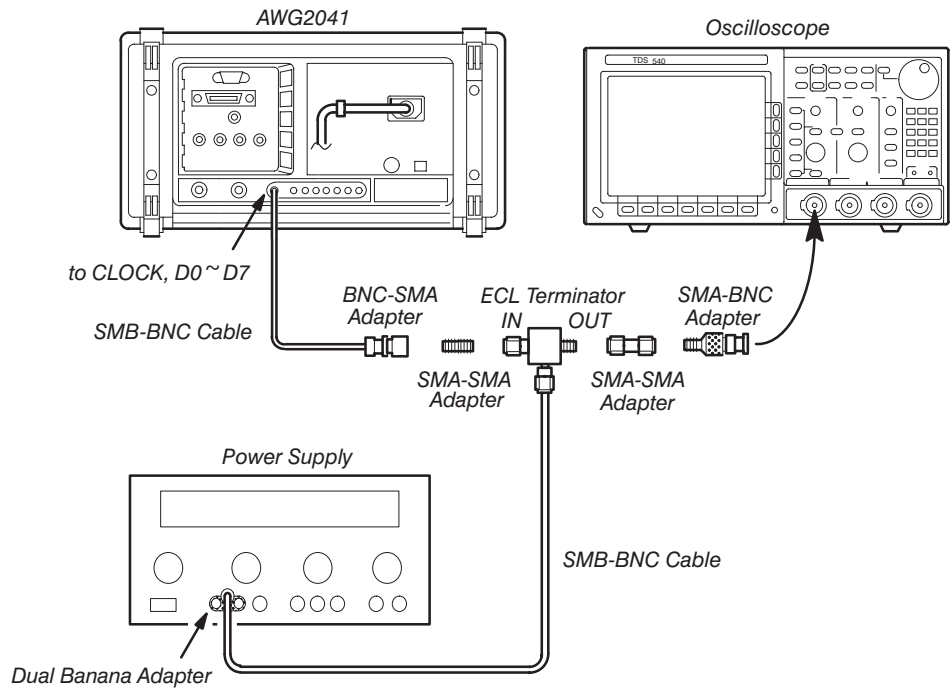

Figure E-23: Digital Data Out Initial Test Hookup

c. Set oscilloscope controls:

Vertical	CH1
CH1 Coupling	DC
Scale	50 mV/div.
Input Impedance	50 Ω
Horizontal	
Sweep	5 ns/div
Trigger	
Source	CH1
Coupling	DC
Slope	Positive
Level	+100 mV
Mode	Auto

d. Set DC power supply controls:

Voltage	-2.45 V
---------	---------

2. Set AWG2041 controls and select waveform file:

- a. Initialize AWG2041 controls: Push **UTILITY**→**Misc**→**Config...**→**Reset to Factory**→**O.K.**

- b. *Select waveform file:*
 - Push **SETUP**→**Waveform Sequence**.
 - Turn the general purpose knob to highlight the **DOUT.WFM** file.
 - Push **ENTER**.
3. *Turn on the AWG2041 CH1 output:* Push the **CH1** button so that the LED above the CH1 output connector is on.
4. *Check the digital data output signals:*
 - a. *Check the clock output:*
 - Check that the oscilloscope displays a square wave with vertical 2 division and horizontal 2 division.
5. *Check the digital data output signals:*
 - a. *Change connection:* Disconnect the cable (BNC-SMB) to CLOCK output and connect it to D0 output connector.
 - b. *Check the digital data output:*
 - Check that the oscilloscope displays square wave with vertical 2 division and horizontal 4 division.
 - c. *Check another digital data output:*
 - Repeat the same procedure as step a and b to check the D1 to D7 output signals.
6. *End procedure:* Turn off the DC power supply output and disconnect the DC power supply and oscilloscope.

Floating Point Processor Check (Option 09)

This procedure checks the AWG2041 floating point processor. This check requires that the AWG2041 has Option 09 installed.

Equipment Required: None.

Prerequisites: The AWG2041 meets the prerequisites listed on page E-7.

Procedure:

1. *Check that floating point processor test in internal diagnostics passes:*
 - a. *Run the AWG2041 internal diagnostics:* Push the AWG2041 **ON/STBY** switch two times so that the AWG2041 runs the power-on diagnostics.
 - b. *Check the FPP test results:* When the AWG2041 finishes the FPP test, check that the test result is Pass.

This completes the performance tests for the AWG2041.

